

CECW-EH Engineer Manual 1110-2-1417	Department of the Army U.S. Army Corps of Engineers Washington, DC 20314-1000	EM 1110-2-1417 31 August 1994
	Engineering and Design FLOOD-RUNOFF ANALYSIS	
	Distribution Restriction Statement Approved for public release; distribution is unlimited.	

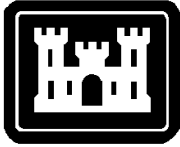

EM 1110-2-1417
31 August 1994

**US Army Corps
of Engineers**

ENGINEERING AND DESIGN

Flood-Runoff Analysis

ENGINEER MANUAL

DEPARTMENT OF THE ARMY
U.S. Army Corps of Engineers
Washington, DC 20314-1000

EM 1110-2-1417

CECW-EH

Manual
No. 1110-2-1417

31 August 1994

Engineering and Design
FLOOD-RUNOFF ANALYSIS

1. Purpose. This manual describes methods for evaluating flood-runoff characteristics of watersheds. Guidance is provided in selecting and applying such methods to support the various investigations required for U.S. Army Corps of Engineers (USACE) civil works activities. The manual references publications that contain the theoretical basis of the methods and detailed information on their use.

2. Applicability. The manual applies to all HQUSACE elements, major subordinate commands, districts, laboratories, and field operating activities having civil works responsibilities for the design of civil works projects.

FOR THE COMMANDER:



WILLIAM D. BROWN
Colonel, Corps of Engineers
Chief of Staff

CECW-EH

Manual
No. 1110-2-1417

31 August 1994

**Engineering and Design
FLOOD-RUNOFF ANALYSIS**

Table of Contents

Subject	Paragraph	Page	Subject	Paragraph	Page
Chapter 1			Construction and Operation		
Introduction			Reporting Requirements		
Purpose	1-1	1-1	Summary		
Applicability	1-2	1-1	Part II Hydrologic Analysis		
References	1-3	1-1	Chapter 4		
Scope and Organization	1-4	1-1	Rainfall Analysis		
Relationship to Other			General		
Guidance	1-5	1-1	Point Rainfall Data		
Part I Problem Definition and			Rainfall Data From Remote Sensors		
Selection of Methodology			Areal and Temporal Distribution		
Chapter 2			of Rainfall Data		
Introduction to Flood-Runoff Analysis			Chapter 5		
General	2-1	2-1	Snow Analysis		
Applications of Flood-Runoff			General		
Analysis	2-2	2-1	Physical Processes		
Nature of Flood Hydrology	2-3	2-2	Data Requirements, Collection,		
Data Considerations	2-4	2-3	and Processing		
Approaches to Flood-Runoff			Simulating Snow Accumulation		
Analysis	2-5	2-3	Simulating Snowmelt		
Chapter 3			Chapter 6		
Study Formulation and Reporting			Infiltration/Loss Analysis		
General	3-1	3-1	General		
Overview of Corps Flood Damage			Gauged versus Ungauged Parameter		
Reduction Studies	3-2	3-1	Estimation		
Planning and Managing the Hydrologic			Antecedent Moisture Conditions		
Investigation	3-3	3-1	Surface Loss Estimation		
Hydrologic Engineering Analysis			Infiltration Methods		
Strategy	3-4	3-2	Impervious Areas		
Hydrologic Requirements for Planning			Method Selection		
Studies	3-5	3-3			
Preconstruction Engineering and					
Design (PED) Phase	3-6	3-6			

Subject	Paragraph	Page
Chapter 7		
Precipitation Excess - Runoff Transformation		
General	7-1	7-1
Runoff Subdivision	7-2	7-1
Unit Hydrograph Approach	7-3	7-1
Kinematic Wave Approach	7-4	7-12
Chapter 8		
Subsurface Runoff Analysis		
General	8-1	8-1
Event-Oriented Methods	8-2	8-1
Evapotranspiration	8-3	8-5
Continuous Simulation Approach to Subsurface Modeling	8-4	8-11
Existing Continuous Simulation Models	8-5	8-16
Parameter Estimation for Continuous Simulation Models	8-6	8-23
Chapter 9		
Streamflow and Reservoir Routing		
General	9-1	9-1
Hydraulic Routing Techniques	9-2	9-2
Hydrologic Routing Techniques	9-3	9-5
Applicability of Routing Techniques	9-4	9-21
Chapter 10		
Multisubbasin Modeling		
General	10-1	10-1
General Considerations for Selecting Basin Components	10-2	10-1
Selection of Hydrograph Computation Locations	10-3	10-2
Calibration of Individual Components	10-4	10-4
Calibration of Multisubbasin Model	10-5	10-4
Verification of the Multisubbasin Model	10-6	10-5
Part III Methods for Flood-Runoff Analysis		
Chapter 11		
Simplified Techniques		
Introduction	11-1	11-1
Rational Method	11-2	11-1
Regional Frequency Analysis	11-3	11-1
Envelope Curves	11-4	11-5
Rainfall Data Sources	11-5	11-6

Subject	Paragraph	Page
Chapter 12		
Frequency Analysis of Streamflow Data		
General	12-1	12-1
Frequency Analysis Concepts	12-2	12-1
Graphical Techniques	12-3	12-3
Numerical Techniques	12-4	12-5
Special Considerations	12-5	12-10
Chapter 13		
Analysis of Storm Events		
Introduction	13-1	13-1
Model Development	13-2	13-1
Model Calibration	13-3	13-2
Simulation of Frequency-Based Design Floods	13-4	13-3
Simulation of Standard Project and Probable Maximum Floods	13-5	13-5
Chapter 14		
Period-of-Record Analysis		
General	14-1	14-1
Simulation Requirements	14-2	14-1
Model Calibration	14-3	14-1
Applications	14-4	14-4
Part IV Engineering Applications		
Chapter 15		
Data Collection and Management		
General	15-1	15-1
Data Management Concepts	15-2	15-1
Geographic Information Systems	15-3	15-1
Data Acquisition and Use	15-4	15-2
Chapter 16		
Ungauged Basin Analysis		
General	16-1	16-1
Loss-Model Parameter Estimates	16-2	16-2
Runoff-Model Parameter Estimates	16-3	16-3
Routing-Model Parameter Estimates	16-4	16-4
Statistical-Model Parameter Estimates	16-5	16-5
Reliability of Estimates	16-6	16-6
Chapter 17		
Development of Frequency-Based Estimates		
Introduction	17-1	17-1
Choice of Methodology	17-2	17-1

Subject	Paragraph	Page
Hypothetical Storm Frequency	17-3	17-2
Transfer of Frequency Information with Hypothetical Events	17-4	17-3
Development of Future-Condition Frequency Estimates	17-5	17-3
Adjustment of Peak Discharges to Represent Stationary Conditions . . .	17-6	17-4

Chapter 18

Evaluating Change

General	18-1	18-1
Evaluating Catchment and Conveyance-System Change	18-2	18-1
Procedure for Evaluating Damage- Reduction Plans	18-3	18-3

Subject	Paragraph	Page
Evaluating Reservoir and Detention Basins	18-4	18-4
Evaluating Channel Alterations and Levees	18-5	18-8
Evaluating Other Alternatives	18-6	18-10

**Appendix A
References**

**Appendix B
Hydrologic Engineering Management Plan for
Flood Damage Reduction Feasibility-Phase
Studies**

Chapter 1 Introduction

1-1. Purpose

This manual describes methods for evaluating flood-runoff characteristics of watersheds. Guidance is provided in selecting and applying such methods to support the various investigations required for U.S. Army Corps of Engineers (USACE) civil works activities. The manual references publications that contain the theoretical basis of the methods and detailed information on their use.

1-2. Applicability

This manual applies to HQUSACE elements, major subordinate commands, districts, laboratories, and field operating activities having civil works responsibilities.

1-3. References

References are listed in Appendix A.

1-4. Scope and Organization

a. The manual is organized into four parts. The first, *Problem Definition and Selection of Methodology*, describes the products of flood-runoff analysis and the types of investigation for which these products are required. Aspects of flood hydrology are discussed, including physical processes, data availability, and broad approaches to analysis. Guidance in formulating study procedures is provided, which includes criteria for method selection and recommended content for a hydrologic engineering management plan (HEMP). The reporting of study results is the focus of the last chapter in Part I.

b. Part II, *Hydrologic Analysis*, provides information on techniques for simulating various components of the hydrologic cycle, including rainfall, snow, infiltration (loss), surface and subsurface runoff, and flow in channels and reservoirs. Multisubbasin modeling and design storm definition are discussed.

c. Part III, *Methods for Flood-Runoff Analysis*, addresses the application of simplified techniques, frequency analysis of streamflow data, precipitation-runoff simulation of storm events, and period-of-record precipitation-runoff simulation. Data requirements and calibration/verification of simulation models are considered.

d. Part IV, *Engineering Applications*, deals with several issues associated with the application of methods from Part III. The processing of data can be time-consuming and costly; techniques for efficient data handling are addressed. The lack of historical streamflow data is the source of much difficulty and uncertainty in flood-runoff analysis. Aspects of dealing with “ungauged” basins are discussed. Issues associated with the development of frequency-based estimates are covered, including the concept of calibration to “known” frequency information. Various aspects of modeling land use change, as well as the effects of reservoir and other projects, are discussed. Finally, three examples illustrate some of the principles presented in this manual.

e. Following Part IV, Appendices A and B provide references, a generic HEMP, and a set of example applications.

1-5. Relationship to Other Guidance

This engineer manual (EM) relies on references and/or technical information in several other guidance documents. Some of those documents are part of this current guidance effort and others are older documents. The most relevant documents are EM 1110-2-1416, *River Hydraulics*, EM 1110-2-1415, *Hydrologic Frequency Analysis*, and EM 1110-2-1413, *Hydrologic Analysis of Interior Areas*. These documents provide the basic technical background for study procedures closely related to flood-runoff analysis or information for how the results of flood studies are used in project analyses. Specific references to these and other EM's are made throughout this document.

PART 1

PROBLEM DEFINITION AND SELECTION OF METHODOLOGY

Chapter 2 Introduction to Flood-Runoff Analysis

2-1. General

This chapter describes products of flood-runoff analysis and relates them to the various types of investigations associated with the Corps of Engineers Civil Works activities. Flood-runoff analysis as described in this manual can be regarded as an engineering application of the science of flood hydrology. Aspects of flood hydrology are briefly described as a precursor to detailed treatment in Part II, *Hydrologic Analysis*. The type, amount, and quality of hydrologic and meteorologic data available for a flood-runoff analysis affect the choice of methodology and reliability of results. Consequences of data availability are discussed. Finally, broad approaches to flood-runoff analysis are presented. The approaches are a framework for a detailed discussion of methods in Part III, *Methods for Flood-Runoff Analysis*.

2-2. Applications of Flood-Runoff Analysis

a. Products of flood-runoff analysis. Products can be categorized with respect to the type of variable (e.g., stage, discharge, volume) and the measure of the variable.

(1) Measure might be simply the magnitude associated with a particular point in time (as in flow forecasting), magnitude associated with a nonfrequency based design flood (e.g., standard project or probable maximum), magnitude associated with duration (e.g., value that is exceeded, or not exceeded, X-% of the time), or magnitude associated with a particular exceedance or non-exceedance frequency. Exceedance frequency measures are particularly common for flood prediction and are the basis for flood risk evaluations (e.g., delineation of the "1-% chance" floodplain for flood insurance purposes), as well as flood damage analysis for project design. In other words, the end product of many flood-runoff analyses is a set of discharge or stage exceedance frequency relations, perhaps for both existing and alternative future conditions, for locations of interest in a watershed. The development of probabilistic estimates of flood runoff is dealt with in Chapter 12, "Frequency Analysis of Streamflow Data," and Chapter 17, "Development of Frequency-Based Estimates."

(2) Generally, water elevation at a location in a river or on a floodplain is of more direct interest for flood analysis than magnitude of discharge. Water elevation is determined with a hydraulic analysis, which is oftentimes

performed subsequent to a hydrologic analysis. However, the hydraulic characteristics of floodwave movement are an important aspect of hydrologic analysis, and there are situations where it is best to incorporate detailed hydraulic analysis directly in the determination of discharge. Chapter 9, "Streamflow and Reservoir Routing," deals with hydraulic aspects of hydrologic analysis, including techniques with which water elevations can be determined.

b. Types of investigation requiring flood-runoff analysis. Types of investigation include flood risk evaluation of floodplains, flood damage evaluation for project planning, design of hydraulic structures for flood control, and flood-runoff forecasting for project operations.

(1) The evaluation of flood risk for floodplains, such as is required for flood insurance studies, requires discharge-exceedance frequency estimates for locations along a stream. Discharges for selected exceedance frequencies are then used in the hydraulic determination of water surface profiles from which maps of inundated areas can be prepared. Hence, the primary product of flood-runoff analysis for these investigations is a set of discharge-exceedance frequency relations for current land use conditions.

(2) Flood damage evaluations for project planning generally require the development of both discharge-exceedance frequency relations and stage-discharge relations for index locations associated with "damage" reaches of a stream. These relations must be developed for existing conditions as well as future conditions with and without proposed projects. The development of such relations is among the most challenging of applications in flood-runoff analysis. Chapter 18, "Evaluating Change," is particularly pertinent to such studies.

(3) Design of hydraulic structures for floods such as the standard project or probable maximum generally requires estimation of the peak stage, discharge, or runoff volume associated with such events. In the case of a large dam, the spillway capacity and height of dam are generally based on routing the spillway design flood (i.e., the probable maximum flood) through the reservoir. Because such events are beyond experience, judgment is required in establishing parameters for the analysis. Chapter 13, "Analysis of Storm Events," deals with aspects of such analyses.

(4) Real-time estimates of flood runoff are used in making operational decisions for reservoirs, reservoir systems, and other hydraulic structures. Precipitation, stage, and other data are transmitted by telemetry systems

to water control centers, where the data are processed and forecasts are made. Although flow forecasting is not dealt with explicitly in this manual, pertinent sections are Part II on hydrologic analysis and Part III sections dealing with precipitation-runoff modeling. Other types of investigation for which flood-runoff analysis may be required include those involving the evaluation of applications for permits to encroach on water bodies and studies involving the design of flood warning systems. In both cases, simplified techniques may be appropriate, some of which are described in Chapter 11, "Simplified Techniques."

2-3. Nature of Flood Hydrology

a. The hydrologic system.

(1) A significant aspect of flood hydrology is the estimation of the magnitude of streamflow at various locations in a watershed resulting from a given precipitation input, as illustrated schematically in Figure 2-1.

(2) The hydrologic system embodies all of the physical processes that are involved in the conversion of precipitation to streamflow, as well as physical characteristics of the watershed and atmosphere that influence runoff generation. The use of computer models to simulate the hydrologic system is of major significance in the performance of many flood-runoff analyses. A fundamental problem in simulating hydrologic systems is to employ the appropriate level of detail to represent those components of the system that have a significant influence on the phenomena being modeled. An associated problem is to acquire and interpret information on watershed characteristics, etc. to enable appropriate representation of the system. Part II, Hydrologic Analysis, is largely devoted to techniques for representing various components of the hydrologic system.

b. *Physical processes.* The hydrologic cycle comprises all of the physical processes that affect the movement of water in its various forms, from its occurrence as precipitation near the earth's surface to its discharge to the ocean. Such processes include interception, water storage in depressions, water storage in lakes and

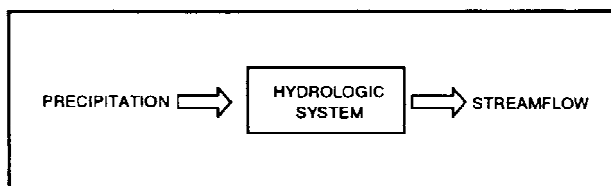

Figure 2-1. Hydrologic system

reservoirs, snow accumulation and melt, infiltration through the earth's surface, percolation to various depths in the subsurface, the storage of water in the subsurface, the lateral movement of water in both unsaturated and saturated portions of the subsurface, evaporation from water bodies and moist soil, transpiration from vegetation, overland flow, and streamflow. The processes are complex and can be defined with varying degrees of sophistication. Some processes are more significant than others for particular types of analysis. For example, if an analysis of runoff from a historical storm with an event-type simulation model were being performed, it would be appropriate to exclude evapotranspiration during the storm event from the analysis. On the other hand, if a continuous (moisture accounting) simulation model were being used for a period-of-record analysis, appropriate representation of evapotranspiration would be very significant.

c. Storm characteristics.

(1) In Figure 2-1, precipitation is viewed as an input to a hydrologic system. The precipitation might be associated with a historical storm, a design storm, or may result from a stochastic generation procedure. Generally, precipitation is averaged spatially (i.e., "lumped") over a subbasin, or perhaps over a geometric "element," if a "distributed" model is being used. Likewise, precipitation intensity is averaged over a time interval. Thus, the precipitation input to the hydrologic system is commonly represented by hyetographs of spatially and temporally averaged precipitation. The development of such hyetographs is addressed in Chapter 4, "Rainfall Analysis."

(2) Each storm type (e.g., convective, frontal, orographic) has predominant characteristics regarding the spatial extent and variability, intensity, and duration of precipitation. Precipitation fields associated with storms, especially the convective type, exhibit substantial spatial and temporal variability. The sampling of such fields with gauge networks of typical density results in precipitation estimates that may be highly uncertain. Indeed, the gauge measurements themselves may exhibit significant uncertainty, primarily due to wind effects. As indicated in Chapter 4, advances in use of radar-based rainfall data may offer a significant improvement in capabilities for defining the spatial and temporal variations of rainfall.

d. *Watershed characteristics.* A key aspect of simulating a hydrologic system is representation of the physical properties of the system. Watersheds are heterogeneous with respect to topography, geology, soils, land use, vegetation, drainage density, river characteristics, etc. In most applications, the properties are lumped on a

subbasin basis and represented by simple indices. The representation of physical properties is dealt with in chapters in Part II that treat components of the hydrologic system.

e. Scale considerations. The techniques that are most appropriate for a simulation model are a function of the scale of the phenomena being modeled.

(1) For example, for small upland basins, a physically based model should recognize a variety of storm-runoff production mechanisms, including overland flow caused by rainfall exceeding infiltration capacity over the entire basin, overland flow caused by rainfall exceeding infiltration capacity over a portion of the basin (partial area overland flow), overland flow caused by a high water table near the stream system, and subsurface stormflow. Even with capabilities to simulate these processes, such models may not perform satisfactorily because of the lack of information regarding spatial variability of rainfall and of subsurface hydraulic properties.

(2) At a larger scale (i.e., larger basins), the processes that are dominant at a smaller scale tend to average out such that different approaches to modeling are appropriate. Emphasis is given to use of the unit hydrograph and (macro scale) kinematic wave methods in this manual. However, application of these methods requires the determination of rainfall excess and the estimation of subsurface contributions to runoff, both of which are the source of substantial uncertainty. Also, at the larger scale, flood wave movement through the stream network becomes a dominant factor affecting the magnitude and timing of flood runoff. Hence, significant attention must be given to streamflow routing. The primary focus in this manual is on basins that are from one to thousands of square miles in size, and for which it is generally necessary to divide the basin into multiple subbasins and perform streamflow routing to obtain total flow at the outlets of downstream subbasins.

2-4. Data Considerations

a. Types and sources of data for flood-runoff analysis. Data may be categorized as that related to physical attributes of a basin, and data pertaining to the historical movement of water (in its various states) through the hydrologic cycle.

(1) Physical attributes include area, surficial geometric characteristics (area, shape, slope, etc.), soil type, land use, vegetative cover, subsurface characteristics (location, size and geometry of subsurface features, hydraulic

conductivities, etc.), and stream channel characteristics (shape, slope, roughness, etc.). Some of these attributes are static, while others may change seasonally or over longer time periods. Generally for flood studies, resources are not expended in acquiring subsurface information, as such information can be very costly to acquire, and use of such information is limited.

(2) Data related to water movement include precipitation, snow depth and other snow-related information, storage of water in surface water bodies, infiltration, soil moisture, movement of water in both unsaturated and saturated portions of the subsurface, evaporation, transpiration, and streamflow (or flow in conduits or other drainage devices). In addition, meteorologic data such as air temperature, solar radiation and wind may be used with energy relations to define water movement. Although a number of these data types might be used in a particular analysis, many flood-runoff studies rely primarily on historical precipitation and streamflow data.

b. Significance of data availability. Because of the complex nature of hydrologic processes, storm characteristics and basin characteristics, the type and amount of data available can have a major influence on the choice of methodology for performing an analysis and on the reliability of results. Part III, *Methods for Flood-Runoff Analysis*, describes the data requirements for various methods. Streamflow data, in particular, is extremely valuable. A relatively long record of streamflow data can be used to make estimates of flood-runoff probabilities that are far more reliable than could be made by any method without such data. Even a short record of streamflow data is valuable because it can be used in the calibration of precipitation-runoff simulation models.

2-5. Approaches to Flood-Runoff Analysis

In this section, general approaches to flood-runoff analysis are described. For each approach, there may be several methods of analysis. These are described in detail in Part III. Selection of methods is discussed in Chapter 3, "Study Formulation and Reporting."

a. Approaches. Methods of flood-runoff analysis are categorized under four approaches, as follows:

- (1) Simplified methods.
- (2) Frequency analysis of streamflow data.
- (3) Precipitation-runoff analysis of storm events.

(4) Period-of-record precipitation-runoff analysis.

(a) Simplified methods may involve use of formulas, previously derived regression equations, envelope curves, etc. as a basis for making hydrologic estimates. The methods may be especially useful for preliminary estimates of the expected magnitude of a variable, or for providing an independent check on estimates developed by other means.

(b) Where adequate streamflow data are available, frequency analysis of such data can be performed to develop exceedance frequency relationships. General aspects of such analyses are described in Chapter 12; details are provided in EM 1110-2-1415, Hydrologic Frequency Analysis.

(c) For situations where historical streamflow data is nonexistent or inadequate for required estimates, a precipitation-runoff simulation model is commonly used for flood-runoff analysis. Generally, such a model *must* be used if it is intended to evaluate flood runoff effects of structural projects or historic or future land use changes. The third approach listed above involves use of a simulation model that is designed for analyzing single storm events. Such models do not perform a continuous water balance and, therefore, must be provided input that describes the state of a basin (in terms of base flow and some measure of wetness) at the beginning of the simulation. Design storms are used with such models to develop exceedance frequency estimates, or design-flood estimates, of hydrologic variables of interest. Care must be exercised in assigning exceedance frequencies to simulated values because the runoff from a storm of specific exceedance frequency does not necessarily have the same exceedance frequency. Chapter 17, "Development of Frequency-Based Estimates," deals with this issue. It is also possible to use an "event" type model to both analyze each of the largest precipitation events of record and develop exceedance frequency estimates by statistical

analysis of the results. This type of discrete event period-of-record analysis requires screening of precipitation data for the largest events and the establishment of initial conditions at the beginning of each event, as discussed in Chapter 13, "Analysis of Storm Events."

(d) The fourth approach is to use a precipitation-runoff simulation model with period-of-record precipitation as an input and to simulate period-of-record sequences of the variables of interest. If exceedance frequency relations are desired, they can be developed by conventional statistical analysis of the period-of-record outputs. Such a model maintains a continuous moisture balance; therefore, the state of the basin at the beginning of each storm event is implicitly determined. The use of such models is conceptually attractive. However, the model requirements in terms of data and the number of parameters that must be calibrated are substantial. Aspects of continuous moisture accounting are described in Chapter 8, "Subsurface Runoff Analysis," and Chapter 14, "Period-of-Record Analysis."

b. Factors affecting choice of approach. The choice of approach for a flood-runoff analysis should take into account required "products" of the analysis, data availability, reliability of results, and resource requirements. With regard to data availability, a key factor is the availability of streamflow data adequate for frequency analysis, if frequency estimates are required. Though not always the case, improved reliability is generally achieved with the use of more sophisticated and comprehensive methods of analysis. There is significant uncertainty associated with virtually *all* hydrologic estimates. It is often advisable to produce estimates by two or more independent methods and to perform a sensitivity analysis to gain information regarding reliability of results. Finally, financial and human resources available for a study can be a controlling factor in choice of methodology. These issues are discussed in Chapter 3, "Study Formulation and Reporting."

Chapter 3 Study Formulation and Reporting

3-1. General

This chapter describes hydrologic engineering analysis strategies, applications, and reporting for flood damage reduction studies. Hydrologic engineering analysis are performed for planning investigations, refinements of previous study findings due to changed conditions in the design phases, and studies that provide information of a potential or impending flood hazard. The primary references for the information of this chapter are: ER 1105-2-100, Guidance for Conducting Civil Works Planning Studies, and ER 1110-2-1150, Engineering After Feasibility Studies.

3-2. Overview of Corps Flood Damage Reduction Studies

a. General. The Corps undertakes studies of water and related land resources problems in response to directives or authorizations from Congress. Congressional authorities are contained in public laws or in resolutions. Study authorizations are either unique specific studies or standing program authorities usually called continuing authorities. The focus of the studies are to determine whether a Federal project responding to the problems and opportunities of concern should be recommended within the general bounds of Congressional interest. The Corps studies for planning, engineering and designing flood damage reduction projects are predicated upon these legislative requirements and institutional policies.

b. Planning studies. Planning studies are termed feasibility studies. Most studies are conducted in two phases.

(1) The first, or reconnaissance-phase study, is fully funded by the Federal Government, normally takes 12 months, and determines if there is a Federal interest and non-Federal support.

(2) The second, or feasibility-phase study, takes up to 3 years to complete, is cost-shared equally between the Federal Government and non-Federal sponsor, and results in recommendations to Congress for or against Federal participation in solutions to the problems identified in the study. The recommendation for Federal participation is generally for construction authorization.

c. Preconstruction engineering and design (PED) studies. PED is a continuation of planning efforts following the feasibility study. This phase of the project development encompasses all planning and engineering necessary for construction. These studies review previous study data, obtain current data, evaluate any changed conditions, and establish the plan for accomplishing the project and design of the primary features. The preparation of general design memorandums, design memorandums, and plans and specifications are cost-shared as required for project construction.

d. Engineering and design. Once the preconstruction engineering and design is completed, remaining engineering and design will continue when the project is funded for construction or land acquisition. This phase includes all remaining feature design memorandums, plans, and specifications needed to construct the project.

e. Continuing authorities studies. These studies are standing study and construction authorities conducted in the same two-phase process as feasibility studies authorized by Congress. Section 205 for small flood control projects and Section 208 for snagging and clearing for flood control (USACE 1989) with limits of \$5,000,000 and \$500,000, respectively, are continuing authorities specific for flood damage reduction.

f. Federal role in flood damage reduction. The Corps represents the Federal perspective in flood damage reduction actions. Studies are performed in response to congressional directives. Problems are identified, solutions proposed and evaluated, and recommendations made to Congress. The principal Federal interest for flood damage reduction studies is in furthering the economic development of the nation. Provided the solution is economically feasible, protection of damageable property from floods is in the Federal interest (USACE 1989).

3-3. Planning and Managing the Hydrologic Investigation

a. General. The hydrologic engineering study must be planned and detailed to allow the effective and efficient management of the technical work. Before any hydrologic modeling or analytical calculations are undertaken, considerable planning effort should be performed.

b. Scope of study. The scope of the study should be resolved early through meetings with the entire interdisciplinary study team and the local sponsor. The time and cost required are a direct function of the study scope and

amount of detail required to fully evaluate the range of problems and potential solutions for the water resources problem(s). The hydrologic engineer should formalize these scoping meetings and any ideas on addressing the problems through preparation of hydrologic engineering work plans which are presented and upgraded through the various phases of the study process. The work plans should be reviewed by the technical supervisor and should be furnished to the study manager. Unusual problems or solutions would make it wise to receive division review also. Work plans are especially important to develop after the reconnaissance report has identified the problems for further analysis in (and prior to initiating) the feasibility report.

c. Study team coordination. Every cost-shared feasibility study has an interdisciplinary planning team (IPT) assigned, headed by a study manager. The team consists of working-level members from economics, hydraulics, geotechnical, design, real estate, environmental, cost estimating, etc. The local sponsor is also a member, although the sponsor may not wish to attend all IPT meetings. Depending on the level of study activity and complexity, frequent meetings of the IPT should be held ranging from once a week to once a month. The advantage of frequent meetings lies in frequent communication and the exchange of ideas between team members. The most successful studies are those having free and easy communication among team members.

d. Quality control and review. The assurance of quality work and an adequate review come from both the technical supervisor and the IPT. The development of a HEMP and the supervisor's concurrence in the methods and procedures for study analysis give the hydrologic engineer a "road map" for the entire study. Frequent updates and consultations between the engineer and the technical supervisor are important. With these steps followed, technical quality should be acceptable for the final report. Similarly, scoping of the problems and necessary hydrologic information supplied to other IPT members will be accomplished through IPT meetings and discussions. Unusual technical problems or policy issues may require the review of higher level authority.

e. Relationship with cost-share partner. The cost-share partner is a full member of the IPT and often provides valuable technical assistance in many areas of the study. The partner also has valuable insights on the study area and its problems which may not be apparent to the study team. The cost-share partner should have as much (or as little) input and access to the planning and technical

analysis as he/she wants. All hydrologic engineering negotiations with the cost-share partner must involve the hydrologic engineer. Sponsor participation in the study process should be continuous. Study layout and scoping, IPT meetings and decisions, alternative evaluation and project selection, and report recommendations and review should all involve the local cost-share partner.

3-4. Hydrologic Engineering Analysis Strategy

a. Overview. Three interrelated activities proposed as a study strategy are establishing a field presence in the study area, performing preliminary analyses, and conducting full-scoped technical analyses using traditional tools and methods tailored to the detail defined by the study type and conditions.

b. Field presence. The hydrologic engineer must spend time in the field throughout all phases of the analysis, from the reconnaissance-phase study through the actual construction. A field presence is required to gather data needed for the study and to maintain continuous contact with local interests involved with the proposed project. Credibility is quickly lost when the engineers involved in the project recommendations have spent little or no time in the study area. The hydrologic engineer's field presence is needed to establish and maintain contacts of local counterparts and determine survey needs, historic event data, channel and floodplain conveyance characteristics, and operation procedures of existing facilities. Field visits should often include other members of the study team and the local sponsor.

c. Preliminary analysis techniques. These techniques represent a suitable strategy to scope the complexity of the overall study, identify problems and tentative solutions, and roughly determine the extent of Federal interest in continuing the project. A preliminary analysis could involve all of the following techniques:

(1) Simplified techniques--often the application of an equation for a peak discharge for a specific frequency, like the USGS regional regression equations. A rough estimate for a design discharge could be used to estimate the required dimensions of a channel modification for costing purposes. Simplified Techniques are discussed in Chapter 11.

(2) Field evaluations--experienced hydrologic engineers can often lay out typical flood reduction measures during a field visit, such as, estimating alignment and height of a levee for protection of a cluster of flood-prone

structures. Problems associated with certain flood-reduction alternatives can often be ascertained in a field inspection.

(3) Results of previous studies--most urban areas have flood insurance studies identifying flood profiles for the 10-, 2-, 1-, and 0.2-percent chance exceedance frequency floods. Although not in sufficient detail to rely on for design studies, this information is often used to estimate existing flooding and potential damage reduction values. Hydrologic studies by other Federal agencies, as well as State, local, and private agencies are also of value.

(4) Application of existing computer models--many study areas have been previously analyzed by the Corps of Engineers or other agencies. An existing computer model of some or all of the study area is often useful to identify flood hazard levels and potential flood reduction measures.

d. Detailed analysis techniques. Detailed studies are a suitable approach for the feasibility-phase and design studies of a project. Detailed analyses are also appropriate during the reconnaissance-phase investigation, although the analyses may be more abbreviated and approximated than for subsequent studies. Essentially all feasibility-phase flood damage reduction studies require detailed analysis of precipitation-runoff, floodflow by frequency and/or modeling, river hydraulics, and storage routing. Each of these component studies may represent a significant effort. Therefore, it is not unusual for a hydrologic engineer assigned to a feasibility study to require 12 to 24 months of intensive, full-time effort to perform the analyses (USACE 1988).

3-5. Hydrologic Requirements for Planning Studies

a. Overview. The analysis scope and detail required to conduct a hydrologic study depends on the type of study, complexity of the study area, problems identified, potential solutions, and availability of needed data and information. This is particularly true in the reconnaissance-phase investigation, after which the scope and detail becomes more focused. A description of the study requirements and associated hydrologic analyses methods typically needed for reconnaissance and feasibility studies follows. The methods are variable and should be scoped to specific study needs.

b. Reconnaissance-phase study. The reconnaissance-phase study develops and documents the information for a decision to proceed with feasibility-phase investigations.

It also forms the basis for negotiating the feasibility study cost-sharing agreement (FSCA). Reconnaissance-phase studies are conducted over 12 months or for special cases 18 months. Table 3-1 lists the technical elements for conducting the hydrologic engineering analysis of a reconnaissance-phase flood damage reduction study. The objectives are to define the flood problem, determine whether further study will likely result in a feasible solution to the flood problem, determine if there is Federal interest, identify a local cost-sharing sponsor; and, if the findings are positive, determine the scope and define the tasks for completing the feasibility investigation. The hydrologic engineer is a key participant in objectives 1 and 2 and must formulate in detail the HEMP as part of the Initial Project Management Plan (IPMP) for the feasibility-phase study (objective 5). Appendix B provides a generic example of the HEMP for a typical flood damage reduction study. The HEMP should be modified in scope to meet specific study requirements.

(1) Ideally, it is desirable in the reconnaissance-phase to develop the complete hydrologic engineering analysis for the existing without-project conditions in the detail needed for the feasibility-phase study. The reason for this detail is that the project feasibility is highly sensitive to the hydrologic engineering and economic analyses. This concept is possible in some situations. However, in other situations the lack of available data, the complexity of the study area, and limited time may dictate that a less detailed analysis be performed.

(2) A range of alternatives are formulated that would be reasonable to implement and that represent different kinds of solutions to the specified problems. The alternatives are analyzed in sufficient detail for approximate benefit/cost analyses, to eliminate obviously inferior alternatives from future consideration, and to provide for accurately developing the strategy, resources and cost of the feasibility study. The benefit and thus hydrologic engineering analysis is normally based only on existing, without-project conditions previously described. The existing with-project conditions are evaluated to the detail required to determine whether a feasible plan with Federal interest will likely result from further study. Future conditions analyses are normally not required for the reconnaissance-phase study.

c. Feasibility-phase study.

(1) The objective of flood damage reduction feasibility-phase studies is to investigate and recommend solutions to flood related problems. The feasibility-phase is

Table 3-1
Reconnaissance-Phase Study Technical Elements of Work Plan for Hydrologic Engineering Analysis (USACE 1988)

- I. Hydrologic engineering study objectives
 - II. Definition of study area for hydrologic engineering analysis
 - III. Description of available information
 - A. Maps, correspondence, documents, and reports
 - B. Observed flood information
 - C. Previous study data and analysis results
 - IV. Definition of existing conditions flood hazard
 - A. Historic floods documentation
 - B. Hypothetical floods development
 - C. Existing without-project conditions flow frequency, water surface profiles, etc.
 - D. Appraisal of special technical issues: such as erosion/sedimentation, unsteady flow, water quality, future development etc.
 - V. Existing with-project conditions
 - A. Appraisal of broad range of flood loss reduction measures.
 - B. Existing with-project conditions flow frequency, water surface profiles.
 - C. Documentation of flood hazard reduction performance for selected measures.
 - VI. Initial project management plan for feasibility-phase study (HEMP, time, cost, schedule)
-

cost shared 50\50 with a non-Federal sponsor. Typical studies are completed in 18 to 36 months. The majority of hydrologic engineering work is performed in this phase. The hydrologic engineering analysis must be complete so that the project recommended in the feasibility report is essentially what is constructed after detailed engineering and design are completed.

(2) Once the without-project conditions are detailed, the formulation process is iterative, increasing in detail and specificity as the viable measures and plans become more defined. The later stages of the feasibility study therefore show an increase in the engineering and design effort. Sufficient engineering and design are performed to enable further refinement of the project features, baseline cost estimates, and design and construction schedules. The engineering and design also allow design of the selected plan to begin immediately following receipt of the PED funds and the project to proceed through PED without the need for reformulation, General Design Manuals, or postauthorization changes.

(3) Working closely with the study manager, economist, cost engineer, and other members of the IPT, the hydrologic engineer completes the with- and without-project evaluations so that an economically feasible plan is recommended at the completion of the feasibility phase.

This end result requires a continuous exchange of technical information among the various disciplines. The planning process within which the hydrologic engineer functions consists of six major tasks: specification of problems and opportunities, inventory and forecast, alternative plans, evaluation of effects, comparison of alternative plans, and plan selection.

(a) Specification of problems and opportunities. This initial step establishes the base conditions for the planning process, defines the potential type and range of solutions, and provides the essential insight necessary to perform the remaining steps. The major components are definition of flood problem and specification of opportunities. The definition of flood problem component defines the problems and opportunities for solutions to those problems. The information provides the basis for subsequent project development. The nature of flooding, location of threatened properties, and existing project physical and operational characteristics are determined. Information is assembled from the reconnaissance-phase study, field reconnaissances, and other information. Hydrologic engineering investigations develop the specific characteristics of flooding potential in the study area (flood flows and frequency, flood elevations, and floodplain boundaries), character and variability of flooding (shallow or deep, swift, debris-laden, etc.). The specification of

opportunities component defines the general nature of solutions that might be appropriate. The general geography of the watershed, location and density of development, and nature of the flood hazard all interact to reveal possible solutions. Solutions involving reservoirs, levees, and bypasses must be physically possible, reasonable, and not in obvious conflict with critical community values and environmental resources. The community is also a valuable source of ideas early on and throughout the investigation. It is important at this stage to be comprehensive in the exploration of possible solutions, yet equally important for practicality is best use of study time and resources. The hydrologic engineer's practical experience on what does and does not work is most helpful in this phase.

(b) Inventory and forecast. This step develops detailed information about the existing and most-likely future conditions within the watershed and study area. Existing conditions for the study area consist of measures and conditions presently in place. Base condition refers to the first year that the proposed project is operational. Hydrologic engineering analyses are performed for existing and future without-project conditions. Existing measures, implemented prior to the base year, and measures authorized and funded for construction completion prior to the base year are assumed to be in place and included for both the with and without conditions. Future without-condition analyses are conducted for the most likely future development condition projected to occur without the project. This includes changes in land use and conveyances. The assessments are performed for specific time periods. Determination of without-plan conditions is an important aspect of the study process. It is the basis from which the alternatives are formulated and evaluated. Assessments of the without-project conditions should be of sufficient detail to establish viable economic (cost and flood damage), social, and environmental impact assessments of the with-project conditions without future refinements throughout the remaining planning and design study process. Hydrologic analyses include the assembly of data for estimating the flood characteristics, developing discharge-frequency relationships at desired locations, and defining the performance of the without-project conditions. Specific tasks include the following.

- Final data assembly. Most or all of these tasks may have been conducted previously. These data should represent the final information used for feasibility and design studies.

- Obtaining survey and mapping information. Maps showing land use, soil types, vegetation, storm

sewer layouts, bridge plans, and other information from local agencies.

- Precipitation data from the National Weather Service or other agencies.
- Stream gauge stage, discharge, and sediment information from the U.S. Geological Survey or other agencies. Document historic event high-water marks and flood characteristics.
- Hydrologic analysis. This study aspect develops information used in the modeling of the study area and performs the technical analysis.
 - Final delineation of watershed and subbasin boundaries based on stream topology, gauge locations, high-water marks, damage reach flood damage analysis requirements, and location of existing and potential flood damage reduction measures.
 - Develop basic information for hydrologic model (i.e., subbasin areas, rainfall-runoff variables, base flow, recession, and routing criteria).
 - Optimize runoff and loss rate variables using historic event data.
 - Calibrate model to historic event high-water marks and gauged discharge-frequency relationships.
 - Estimate existing without-conditions discharge-frequency relationships at desired ungauged locations using hydrologically and meteorologically similar gaged basins data, regression analysis, and initial hydrologic model results.
 - Determine best estimate discharge-frequency relationships at ungauged locations and, if necessary, adjust initial model variables to calibrate to frequency relationships.
 - Adjust the model runoff and routing variables for most likely future without-project conditions for specific time periods and determine discharge-frequency relationships at desired locations.
 - Provide discharge (or storage)-frequency relationships and other information (risk, performance of the system for a range of events, warning times, etc.) to economists, cost estimators, environmentalist, study manager, and project manager. The

information should also be reviewed by the local sponsor counterparts.

(c) Alternative plans. Alternative plans are formulated to address the flood problems and accomplish other planning objectives. The alternatives are formulated to achieve the national goal of economic development consistent with preservation and enhancement of cultural and environmental values. One or more measures and one or more plans should be formulated to enable the full range of reasonable solutions to emerge from the investigation. In general, the array of alternatives developed should be comprehensive and not simply a range of sizes of a particular measure. The plan formulation exercise is a team process. The hydrologic engineer's knowledge and experience is invaluable to this task and critical to the ultimate formulation of meaningful projects. There are numerous factors to consider when formulating measures and plans. The study authorization should be reviewed as it may require or limit certain actions. The without-conditions analysis defines primary damage centers and flood hazard situations that may tend towards specific types of measures. Real estate and obviously high costs may prohibit certain measures. Environmental and cultural features may require or negate certain actions. The local sponsor may bring specific insights as to problems and potential solutions. In summary, the measures and plans formulated should emphasize comprehensive solutions and also address specific, clearly localized problems.

(d) Evaluation of effects. This step develops the information needed to determine and display the accomplishments and negative effects of measures and plans as compared to the without-project condition. The evaluation process is conducted across the full perspective of concerns - hydrologic engineering, economic, environmental, and others. Hydrologic analysis of flood damage reduction measures and actions are performed for several combinations of measures and plans, operation plans, and performance targets. The initial evaluation should assess the potential for improved operation of the existing system if such components are in place. If improved operation procedures are found viable, they should be detailed and incorporated as part of the existing without-project conditions. The hydrologic analysis procedures for existing and future with-project conditions are similar to the without conditions. The measure effects are incorporated or determined by the modeling process. Frequency and project performance information at all important locations are defined by the without-project condition analysis. The analysis includes the full range of hydrologic events including those that exceed the design levels.

(e) Comparison of alternative plans. This step is identified separately to ensure that the measures are compared on a consistent basis. Direct application of hydrologic analysis criteria may include project performance and safety information (design flows, risk, warning times, consequences of design exceedance, etc.), safety, and operation considerations. Indirectly, hydrologic analysis information is used to assist in determination of flood damage, stream profiles, fluvial hydraulics, environmental effects, and cost aspects. Therefore, the hydrologic engineer is an active participant in the comparison of alternative plans for flood damage reduction.

(f) Plan selection. Plan selection takes place in a diffused decision process. The study manager, technical staff, including the hydrologic engineer, and the local sponsor may strongly influence the recommended plan. The selecting officer at the field level is the district engineer. The division and Board of Engineers for Rivers and Harbors perform subsequent independent review and may recommend a different plan, but in most circumstances the district's plan is ultimately implemented. Plan selection at the district field office level must consider existing laws and regulations applicable to the Corps and other agencies. The recommended plan must be the plan that meets all the statutory tests and maximizes the economic contribution to the nation. It is at this stage that the hydrologic engineer must demonstrate that the recommended plan can perform its intended flood damage reduction function safely and reliably over the full range of hydrologic events.

3-6. Preconstruction Engineering and Design (PED) Phase

a. The PED phase begins after the division engineer issues the public notice for the feasibility report and PED funds are allocated to the district. Emphasis in this phase is typically on the hydraulic design aspects, since the hydrologic analyses should have been completed in the feasibility-phase study. If, however, it is determined during the PED phase that a general design memorandum (GDM) will be necessary because the project has changed substantially or for other reasons, part or all of the hydrologic analyses may need redoing. The hydrologic engineering analysis would be conducted as a feasibility-phase study and reported and documented as such in a GDM.

b. The hydrologic engineer is more involved in the detailed design of the project components, with the overall component capacities, general design, etc., held relatively constant from the feasibility report. For instance, the

feasibility report may have recommended 5 miles of channel modifications having specified channel dimensions. The design memorandum would refine these dimensions to fit the channel through existing building and bridge constraints; to perform detailed hydraulic design of tributary junctions, bridge transitions, drop structures, and channel protection; and conduct detailed sediment transport studies to identify operation and maintenance requirements and other hydraulic design aspects. If necessary, physical model testing is also performed during the design memorandum phase. No additional plan formulation, economics, etc., should be required. Structural design, geotechnical analysis, cost engineering, and other disciplines work to finalize their analyses with the additional topographic site surveys and subsurface information normally obtained in this phase. The hydraulic design is often being continuously modified to reflect these ongoing design problems prior to completion of detailed design.

3-7. Construction and Operation

Unforeseen problems during construction frequently involve further modification and adaptation of the hydraulic design for on-site conditions. Similarly, most projects require detailed operation and maintenance manuals, and hydrologic engineering information can be a critical part of these manuals. The operation of reservoirs, pumping stations, and other flood mitigation components can require considerable hydrologic operation studies to determine the most appropriate operating procedures. Postconstruction studies are necessary for most projects. Most of these studies monitor sediment deposition and scour caused by the project to ensure that adequate hydrologic design capacity is maintained to monitor the correctness of the data used in analyzing the project and to estimate the remaining useful life of the project.

3-8. Reporting Requirements

a. General. Reporting requirements for the various types of studies are described in applicable ER's. In addition, hydrologic and hydraulic Engineer Technical Letters (ETL's) summarize the array of hydrologic data that must be presented for planning reports and suggest display formats. The goal of reporting (investigation findings) should be to describe in basic terms the nature of the flood problem, status and configuration of the existing system, the proposed system and alternatives, performance characteristics of the proposed system, and important operation plans. This section presents a general structure for reporting results of the hydrologic studies

commensurate with the basic concepts of feasibility-phase studies. Note that it is sometimes suggested that economic and other data be included so that the consequences of the hydrologic evaluations may be better judged. Hydrologic reporting requirements should include a description of the without conditions, an analysis of alternative flood loss reduction plans, analytical procedures and assumptions used, and system implementation and operation factors influencing the hydrologic aspects of the study.

b. Existing system. The existing system should be defined and displayed schematically and by the use of maps, tables, and plates. The layout of the location of existing flood damage reduction measures should be indicated on aerial photographs or other suitable cartographic materials. Important environmental aspects, damage locations, and cultural features should also be indicated.

c. Without-project conditions.

(1) Physical characteristics and features of existing condition flood-loss mitigation measures will be described and shown in tables and plates. Dimensions of gravity outlets, channels, and other measures shall be specified. Area capacity (storage-area-elevation) data of detention storage areas will be presented. Watershed and subbasin boundaries will be shown on a plate or map.

(2) The hydrologic analysis approach adopted, critical assumptions, and other analysis items for existing conditions will be described and illustrated as necessary. Historic and/or hypothetical storms, loss-rate parameters, runoff-transform parameters, routing criteria, and seepage will be described and depicted via tables and plates. Hydrologic flow characteristics, peak discharge, duration, frequency, and velocity information will be presented for important locations (damage centers, high hazard areas, locations of potential physical works). Schematic flow diagrams indicating peak discharges for a range of events will be included for urban areas. Presentation of several hydrographs of major hydrologic events, including precipitation and loss rates and runoff transforms, can greatly assist in explaining the nature of flooding.

(3) Future without-project conditions will be described as they impact on hydrologic conditions, assumptions, and procedures. Changes in runoff and operation resulting from future conditions will be described in terms similar to the existing conditions description. Procedures adopted for parameter estimation for future conditions should be described.

d. Hydrologic analysis of alternatives.

(1) The location, dimensions, and operation criteria of components of the alternative plans will be described and depicted on tables and plates. Locations of the alternative measures or plans will be displayed on aerial photographs and/or other cartographic materials so that comparisons with existing conditions may be readily made. Impacts of measures and plans on flood hydrographs (peaks, durations, velocities) for a range of events will be provided at similar locations, as for without conditions. Display of the effects on hydrographs should be included. Display of residual flooding from large (1-percent chance and standard project flood) events is required.

(2) The hydrologic description of the various alternative plans will include a description of the required local agreements and maintenance requirements. The hydrologic consequences of failure to adequately fulfill these requirements will also be presented.

(3) Also presented are the basis and results of hydrologic and hydraulic studies required to determine the functional design and real estate requirements of all water control projects.

(4) The residual flood condition with the selected plan in place will be described. As a minimum, the information will include the following: warning time of impending inundation; rate-of-rise, duration, depth and velocity of inundation; delineation of the best available

mapping of the flood inundation boundaries; identification of potential loss of public service; access problems; and potential damages. This information will be developed for each area of residual flooding for historic, standard project flood, 1-percent chance flood and the flood event representing the selected level of protection. This information will be incorporated into the operation and maintenance manual for the project and disseminated to the public (ER 1110-2-1150, EM 1110-2-1413, ER 1105-2-100).

3-9. Summary

a. The Corps of Engineers utilizes feasibility planning, requiring the local partner to participate financially in the study process. These Corps of Engineers fiscal requirements of the partner must also allow more partner participation in the study selection process. Further local sponsor understanding of the hydrologic engineering analysis requirements, from the feasibility study through the detailed design, should allow for a better final product.

b. The hydrologic engineering study must be planned in enough detail to enable effective and efficient management of the technical analysis. Detailed scoping of the study will enable the study manager to identify and address any potential problems early. The cost-shared partner should be considered a full member of the team. All hydrologic engineering negotiations with the cost-shared partner must involve the hydrologic engineer.

PART II
HYDROLOGIC ANALYSIS

Chapter 4 Rainfall Analysis

4-1. General

a. The use of rainfall data is essential and fundamental to the rainfall-runoff process. The rainfall data are the driving force in the relationship. The accuracy of the rainfall data at a point (i.e., at the rain gauge) is extremely significant to all the remaining use of the data.

b. This chapter describes the significance of rainfall data to the rainfall-runoff process. The relationship between point rainfall at a rain gauge and the temporal and spatial distribution of rainfall over the watershed of interest is discussed. Limitations and inaccuracies inherent in these processes are also defined.

4-2. Point Rainfall Data

a. Rainfall measured at a rain gauge is called point rainfall. The rain is captured in a container. The standard rain gauge, shown in Figure 4-1, is an 8-in.-diam metal can. A smaller metal tube may be located in this larger overflow can. An 8-in.-diam receiver cap may be on top of the overflow can and is used to funnel the rain into the smaller tube until it overflows. The receiver cap has a knife edge to catch rain falling precisely in the surface area of an 8-in.-diam opening.

b. Measurements are made using a special measuring stick with graduations devised to account for the 8-in. receiver cap opening, funneling water into the smaller tube. When the volume of the smaller tube is exceeded, the volume from the smaller tube is dumped into the larger overflow can.

c. Other types of rain gauges are also available. In contrast to the nonrecording gauge which requires an observer to manually measure the rain at regular intervals (i.e. every 24 hours), Figure 4-2 shows a weighing-type recording gauge which does not require constant observation. The rain is caught in a standard 8-in. opening but stored in a large bucket that sits on a scale. The weight of the water caught during a short time interval is recorded on a chart graduated to units of linear distance (inches or millimeters) versus time.

d. Other variations of these two gauges exist and perform similarly. Although essentially all United States gauges have exactly an 8-in. opening and have been

carefully calibrated for exact measurement with an appropriately graduated stick or chart, several other conditions affect the exact amount of rain caught in the gauge.

e. The gauges are affected by wind, exposure, and height of gauge. Researchers have tried to establish correction charts for windspeed effect on the catch, but since exposure (including gauge height) has such significant impacts on the catch, these charts must be viewed with suspicion. The effect of height has been standardized in the United States at 31 in. Windshields, Figure 4-2, have been used at some locations to minimize the inaccuracy of measurement due to windspeed.

f. Other errors are associated with the volume of water displaced by the measuring stick (a constant of 2 percent) or the inherent errors associated with the mechanical aspects of some other types of gauges (i.e., tipping bucket), which are variable as a function of rain intensity. Variable error associated with mechanical gauges should be evaluated by comparing recorder data against standard gauge data and correction relationships determined for future use.

4-3. Rainfall Data From Remote Sensors

a. Rain gauges measure the amount of rain that has fallen at a specific point. However, hydrologists and hydrologic models typically need the amount of rain that has fallen over an area, which may be different than what was measured at a few points. A better estimate of rainfall may be achieved by installing more rain gauges (a dense gauge network), but such a network is very expensive. Alternatively, weather radar, when adjusted with rain gauge data, may provide a relatively accurate measurement of the spatial distribution of rainfall. If the area is in a remote region, where there are few or no rain gauges and weather radar is not available, environmental satellite data may provide rough estimates of rainfall amounts.

b. Radar (Radio Detecting And Ranging) operates on the principle that an electromagnetic wave will be partially reflected by objects or particles encountered by the wave. Generally, a radar system consists of a transmitter, which generates electromagnetic pulses; a movable dish-shaped antenna, which serves both to transmit the electromagnetic pulses and receive reflected signals; a receiver that detects and amplifies the reflected signals; and a device to process and display these signals. The radar antenna transmits electromagnetic pulses into the atmosphere slightly above horizontal. These pulses travel at the

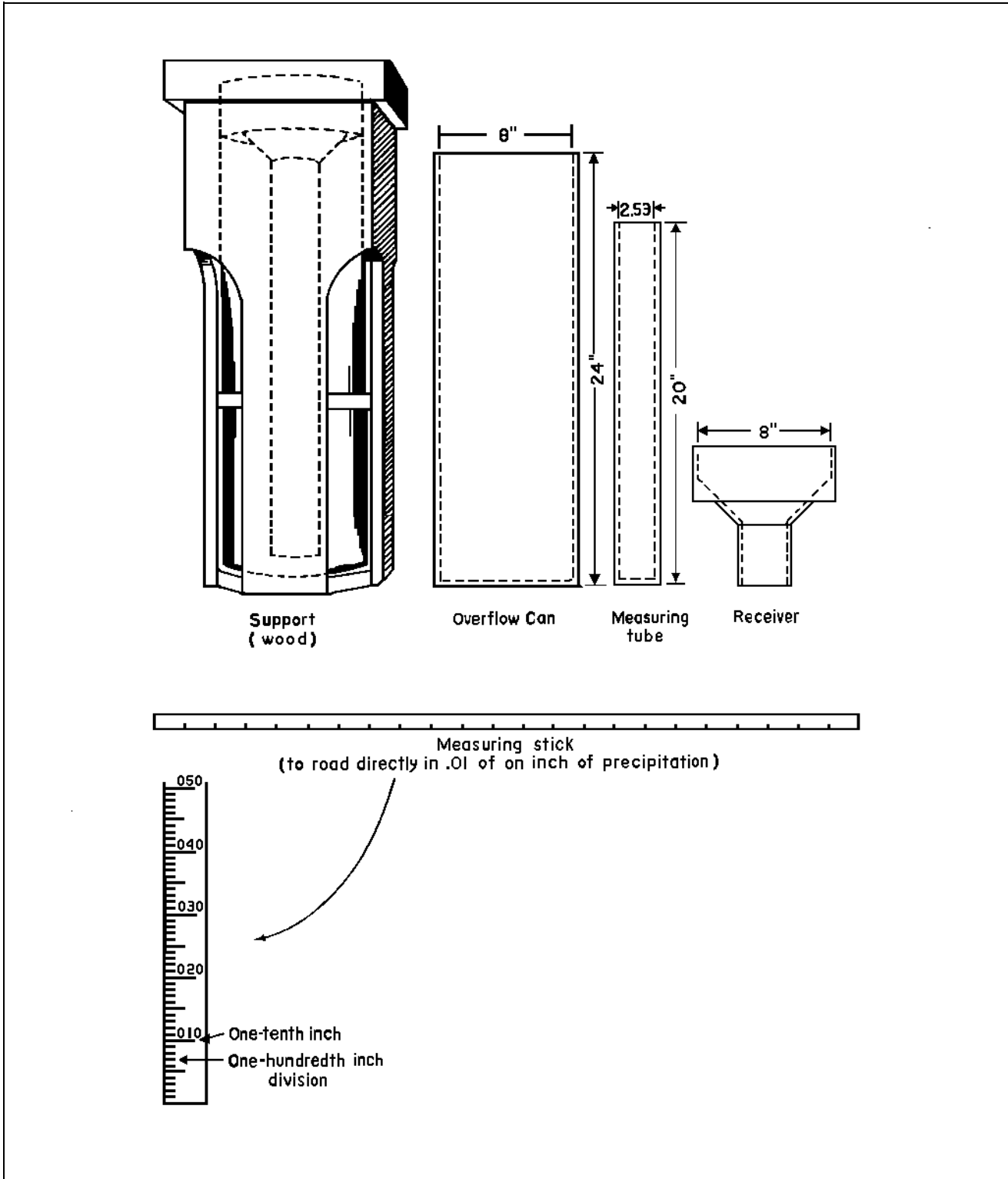

Figure 4-1. Nonrecording gauge, 8-in. opening (U.S. Weather Bureau standard rain gauge)

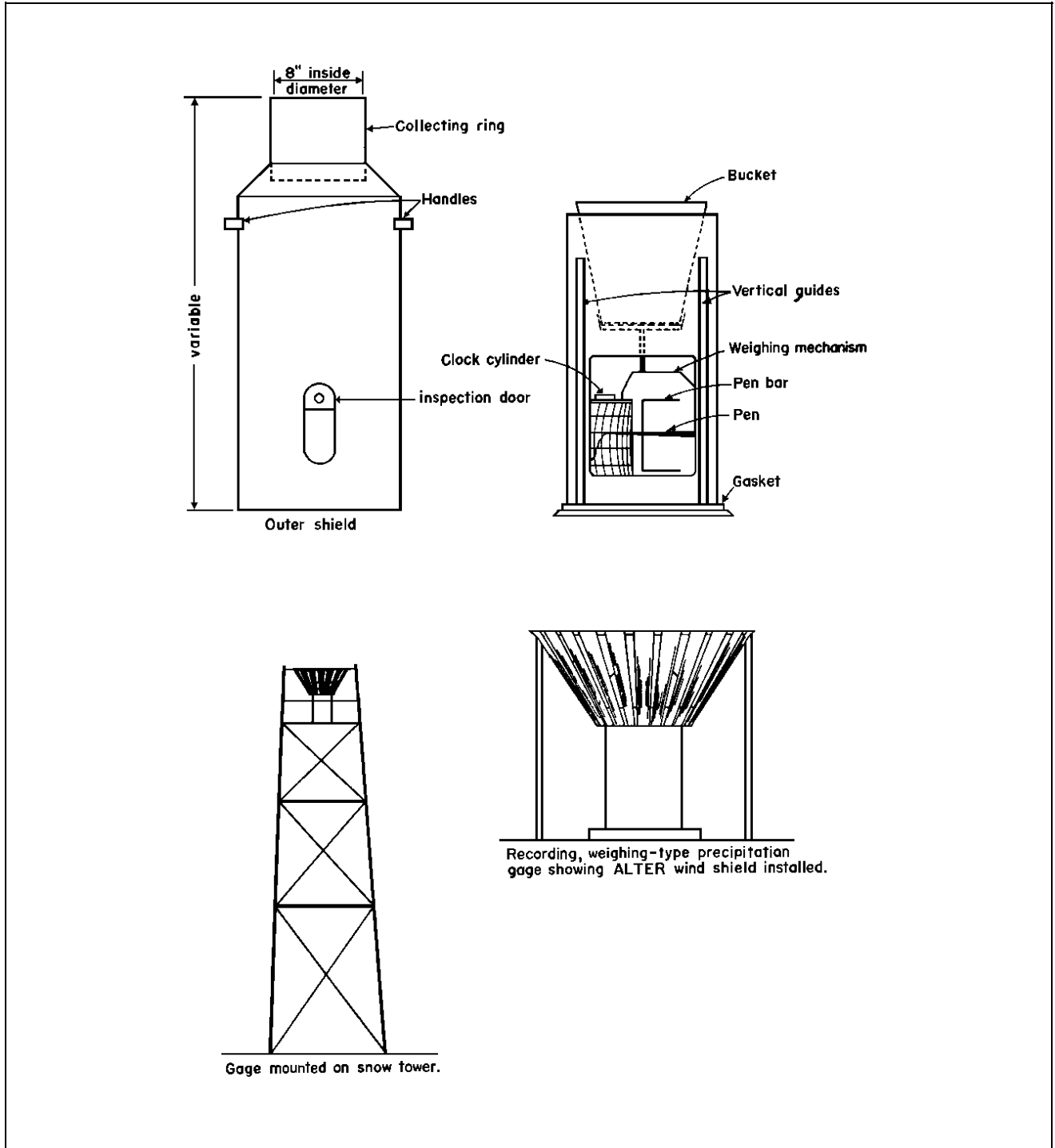

Figure 4-2. Weighing type recording rain gauge (from U.S. Weather Bureau source)

speed of light. As the pulses encounter raindrops (or other objects), the signal is partially reflected towards the antenna. The power and timing of the received signal (or echo), relative to the transmitted signal, are related to the intensity and location of rainfall.

c. Weather radars generally employ electromagnetic pulses with a fixed wavelength of between 3 and 20 cm. A radar with a shorter wavelength is capable of detecting fine rain particles, but the signals will be absorbed or attenuated when they encounter larger storms. A longer wavelength radar will have little signal attenuation, but it cannot detect low-intensity rain.

d. Doppler radars can detect a "phase shift" (a slightly different frequency of the pulse than when transmitted) of a returned pulse. The velocity of the atmospheric particles which reflected the pulse can be calculated from this phase shift. This information is very important in detecting and predicting severe storm phenomena such as tornados but is not generally useful in computing rainfall intensity.

e. The rainfall rate "R," can usually be computed from the reflectivity "Z," which is related to the amount of power in the returned pulse, using the formula:

$$Z = 200 * R^{1.6}$$

where

$$Z = \text{reflectivity, measured in units of mm}^6/\text{m}^3$$

$$R = \text{rainfall rate, given in mm/hr}$$

The constant (200) and the exponent (1.6) vary depending on the size and type of precipitation encountered. If hail or snow are encountered by the pulse, the reflectivity will be much higher than that for rain.

f. There are several factors which can cause erroneous rainfall rates to be computed from radar data. The more prevalent problems are:

(1) Anomalous propagation, where atmospheric conditions cause the radar beam to bend toward the earth. The beam may be reflected by the ground or objects near the ground, producing false echoes and indicating rainfall (usually heavy) where there are none. Anomalous propagation can be screened by using cloud cover information from satellites or from a knowledge of the atmospheric conditions in the area.

(2) Incorrect parameters in the reflectivity-rainfall rate formula (or "Z-R relation"). The parameters given have been determined for "typical" rainfall drop size distributions, and may vary considerably, depending on the storm. Also, if the beam encounters other types of precipitation, such as snow or hail, these parameters would greatly overestimate the rainfall amount if not modified to match the precipitation type.

(3) Attenuation is the reduction in power of the radar pulse as it travels from the antenna to the target and back and is caused by the absorption and the scattering of power from the beam. Attenuation from precipitation usually appears as a "V" shaped indentation on the far side of a heavy cell and causes the rainfall to be underestimated in this region.

(4) Evaporation and air currents that cause the rainfall rate in the atmosphere, measured by the radar are different than the rate at ground level. Evaporation is the most prominent at the leading edge of a storm, when the air mass near the surface is relatively dry.

(5) Hills and buildings near the radar site can reflect the beam and cause ground clutter. This clutter may also reduce the effectiveness of the radar for areas beyond these objects. Typically, a weather radar is ineffective within a 15- to 20-mile radius.

g. The effect of these factors is that rainfall amounts computed for an area with radar data will typically be inaccurate. However, rain gauge data can be combined with the radar data to estimate rainfall amounts that are superior to either radar or rain gauge data alone. It should be noted that a correct method must be applied when combining the two data sets, or the combined set may be more erroneous than either set alone.

h. In a joint effort of the Department of Commerce, the Department of Defense, and the Department of Transportation, NEXRAD (Next Generation Weather Radar) was developed. The NEXRAD system will incorporate approximately 175 10-cm Doppler radars across the United States. NEXRAD will provide many meteorological products, including several precipitation products. One of the main graphical products is a 1- or 3-hour accumulation of rainfall, displayed on a 2- by 2-km grid to a range of 230 km from the radar site. An important hydrological product is the digital array of hourly accumulations. This product gives rain gauge adjusted rainfall amounts for a 4- by 4-km grid for the area covered by a single NEXRAD radar. Another product "mosaics" the

digital products from different NEXRAD sites together, to produce a single-digital rainfall array over a watershed. These digital products can be used as input to rainfall-runoff models for improved results in forecasting or in traditional hydrologic studies.

i. Environmental satellites, such as the GOES system, can provide rough estimates of precipitation over a region. Such satellites cannot measure precipitation directly, but can measure spatial cloud cover and cloud temperature. The approximate height of the top of clouds can be calculated from the temperatures measured by the satellite. The colder a cloud is, the higher the top of the cloud is. In general, clouds with higher tops will yield more precipitation than those with lower tops. If the cloud temperature satellite image is correlated with a rain gauge on the ground, an approximate spatial distribution of the rainfall amounts in that area can be estimated. However, rain gauge data alone provide a more accurate measurement of rainfall over an area than that which is estimated with satellite and gauge data.

j. Satellites can be useful in estimating rainfall amounts in regions where little or no rain gauge data are available, such as areas in Africa. In these regions, estimates of rainfall may be calculated for hydrologic studies, such as sizing a dam, using satellite data (which may have many years of data recorded) when there are no rain gauge data available.

4-4. Areal and Temporal Distribution of Rainfall Data

a. Network density and accuracy. For the application of point rainfall data to a rainfall-runoff calculation, a basin average rainfall must first be determined.

(1) This need raises the question about a proper density of rain gauges (recording and/or nonrecording gauges per square mile of drainage area.) No definite answer exists for this question. Adequate coverage is related to the normal variation in rainfall for a specific region. If thunderstorms account for a major source of rainfall in the specific area, an even denser network of rain gauges is needed.

(2) Average density in the United States is about one gauge for every 250 to 300 square miles. Studies have shown that with this density, a standard error of about 20 percent for a 1,000-square-mile basin is expected if thunderstorms are the major source of precipitation. As shown in Figure 4-3, four times the average density of gauges is required to reduce the error of measurement by

10 percent. These results are derived from data in the Muskingum River basin in Ohio. Mountainous terrain requires a denser network for the same level of error, and plains require a less dense network. If the major source of rainfall is the frontal-type storm pattern, rainfall variations are less than from thunderstorms and less dense gauge networks will suffice.

b. Areal distribution. Several methods are available and routinely used to calculate basin average rainfall from an assumption of areal (i.e., spatial) distribution using point rainfall from a gauge network. The most common, useful method is the Thiessen Polygon.

(1) The Thiessen method weighs each gauge in direct proportion to the area it represents of the total basin without consideration of topography or other basin physical characteristics. The area represented by each gauge is assumed to be that which is closer to it than to any other gauge. The area of influence of each gauge is obtained by constructing polygons determined by drawing perpendicular bisectors to lines connecting the gauges as shown in Figure 4-4a.

(2) The bisectors are the boundaries of the effective area for each gauge. The enclosed area is measured and converted to percent of total basin area. The polygon weighted rainfall is the product of gauge rainfall and the associated polygon area in percent. The sum of these products is the basin average rainfall.

(3) The Thiessen method is usually the best choice for prairie states during thunderstorms, since elevation differences (topographic) are insignificant and gauge density is inadequate to use other methods to define the areal pattern of the thunderstorm cells. When analyzing several storm events having different gauges reporting for each event, the Thiessen method becomes more time-consuming than other techniques to be discussed.

(4) Another popular method is the Isohyetal method, which provides for consideration of topographic effects and other subjective information about the meteorological patterns in the region. A rainfall-depth contour map is determined by tabulating gauge rainfall on a map of the region and constructing lines of equal rainfall called isohyets as shown in Figure 4-4b. Average depths are obtained by measuring the areas between adjacent isohyets (zones). Each increment of area in percent of total basin area is multiplied by the estimated rainfall depth for that area. This product for each zone is summed to obtain the basin average rainfall.

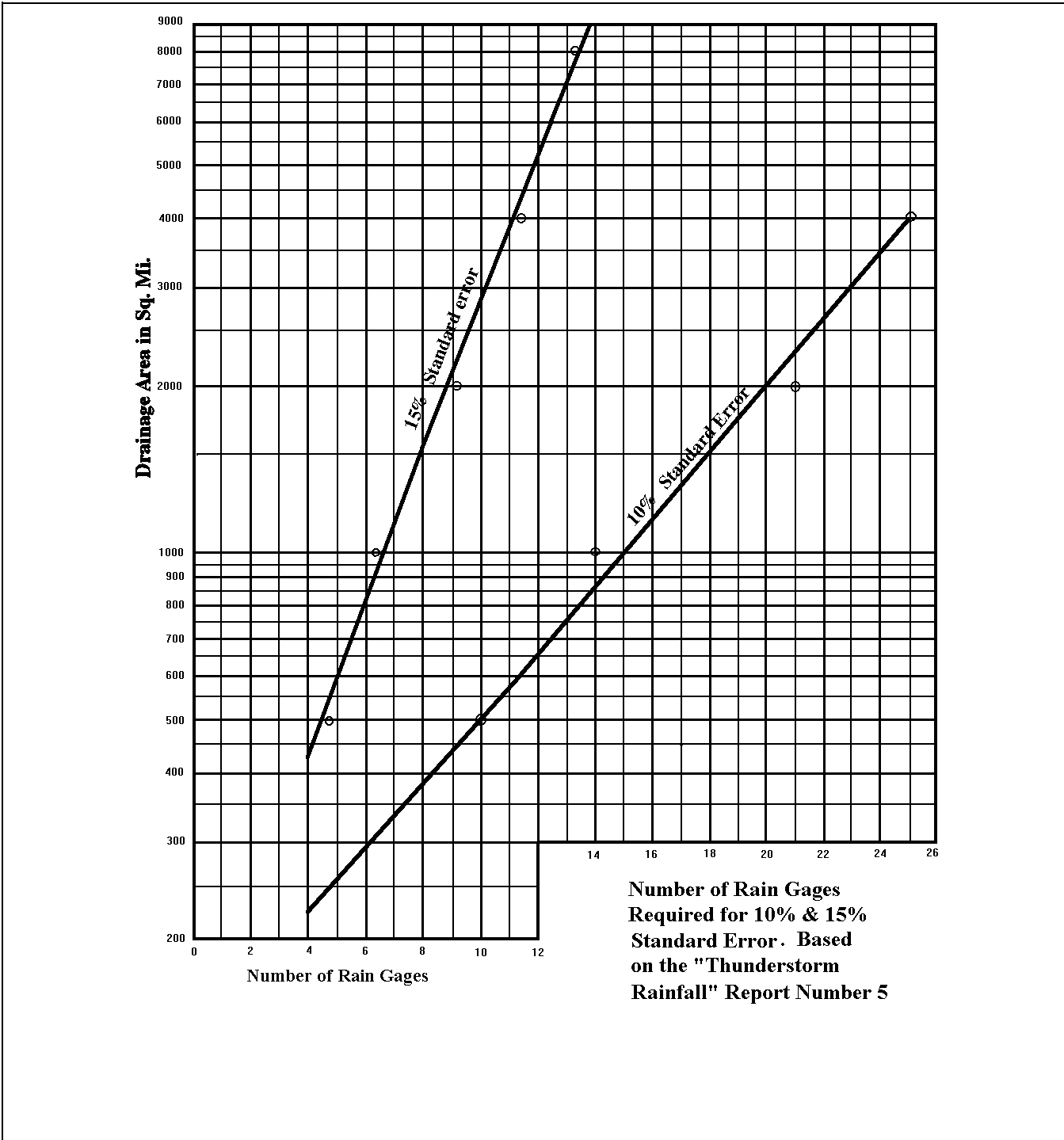

Figure 4-3. Number of rain gauges required for 10 and 15 percent error (U.S. Department of Commerce 1947)

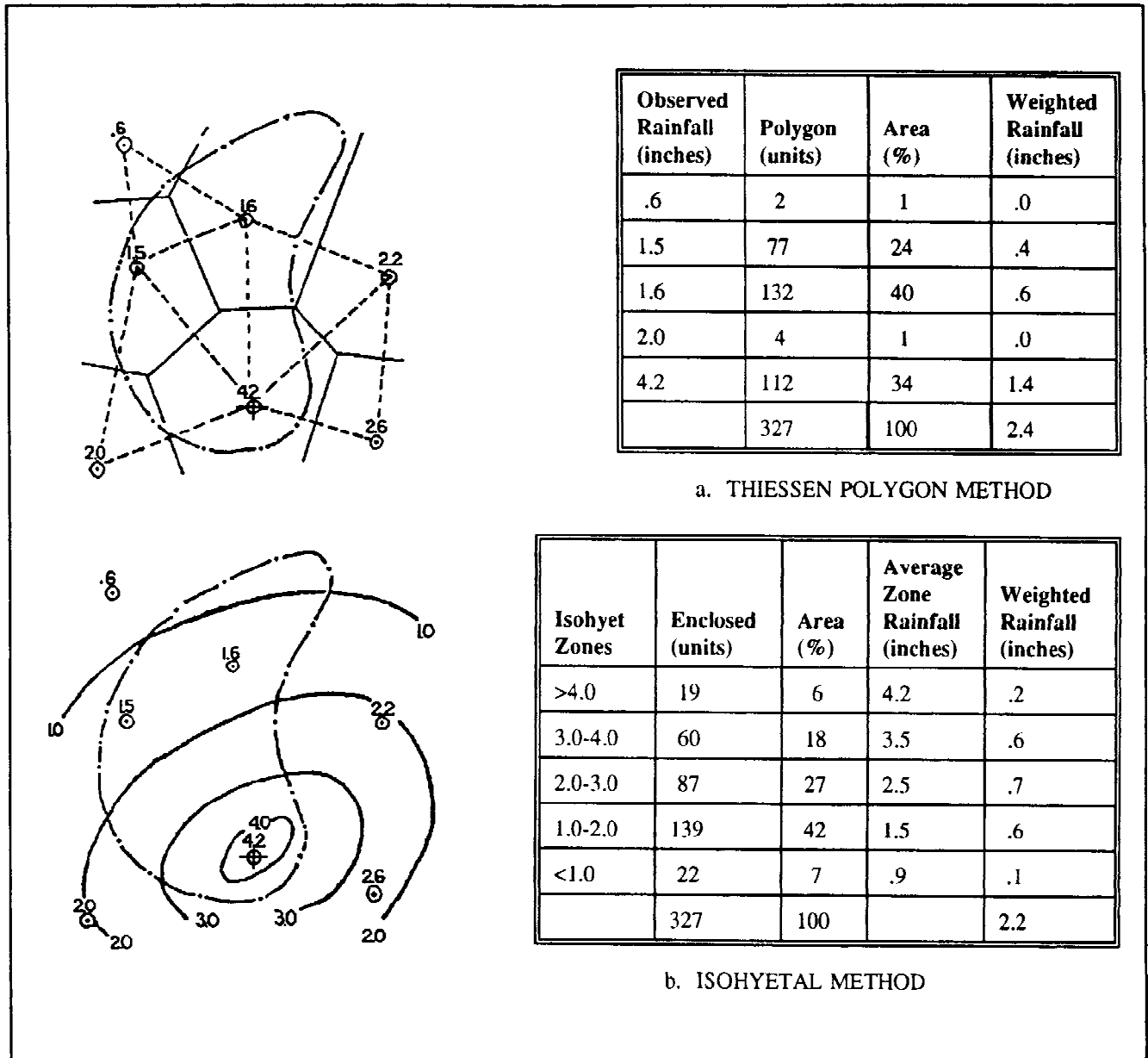

Figure 4-4. Basin average rainfall analysis techniques

(a) The Isohyetal method allows the use of judgment and experience in drawing the contour map. The accuracy is largely dependent on the skill of the person performing the analysis and the number of gauges. If simple linear interpolation between stations is used for drawing the contours, the results will be essentially the same as those obtained by the Thiessen method.

(b) The advantages of both the Thiessen and Isohyetal methods can be combined where the area closes

to the gauge is defined by the polygons but the rainfall over that area is defined by the contours from the Isohyetal method. This combination also eliminates the disadvantage of having to draw different polygon patterns when analyzing several different storm events with a variety of reporting gauges. Regardless of the technique selected for analysis of basin average rainfall, a regional map of areal distribution for the total storm event is also produced.

c. Temporal distribution. Having already determined basin average rainfall, one or more recording gauges in or near the watershed of interest must be located and used as a pattern to estimate the temporal (i.e., time) distribution of the basin average rainfall.

(1) If only one recording gauge is available, it must be assumed that the temporal distribution of the total storm rainfall at the recording gauge is proportional to the basin average rainfall distribution. The calculations necessary to perform this evaluation are shown in Figure 4-5.

(2) If more than one recording gauge is available, a weighted average combination distribution can be

tabulated and used in the same manner as the distribution at a single gauge. Caution should be used when utilizing more than one recording gauge to develop the temporal distribution of a storm event. If the event is a short-duration, high-intensity storm and the timing of the center of mass of the rainfall is different between the gauges, traditional averaging can often result in a storm of longer duration and much lower intensities than what was recorded at each of the gauges. If this is the case, it is often better to use the recording gauge that is closest to the center of mass of the subbasin as the temporal distribution, and only utilize the other gauges in estimating the average depth of rainfall over the subbasin.

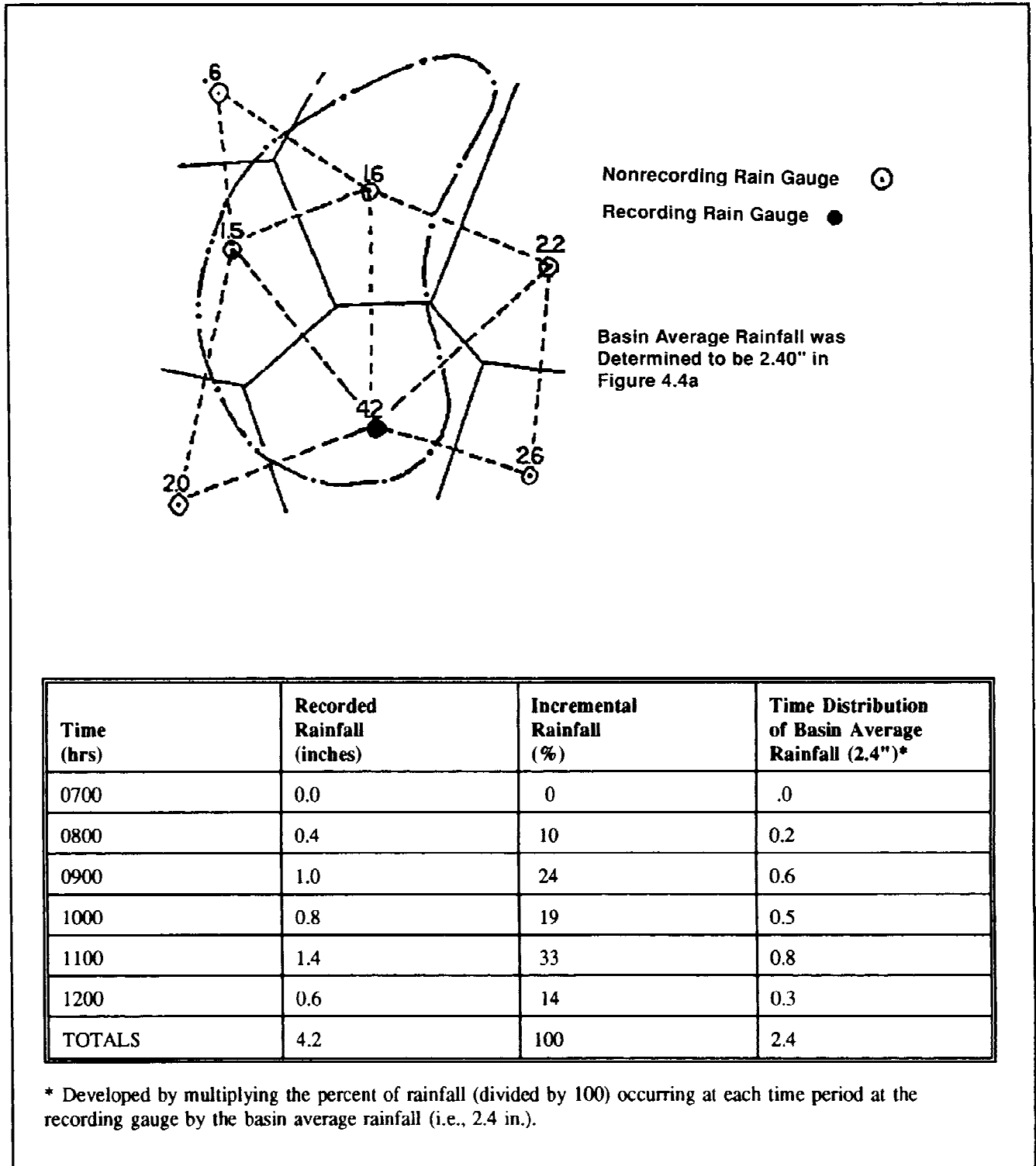

Figure 4-5. Time distribution of basin average rainfall

Chapter 5 Snow Analysis

5-1. General

The simulation of flood runoff may involve a key factor which affects the determination of precipitation excess; that is, precipitation may or may not fall in its liquid form and thus may not be immediately available for runoff. Furthermore, if snow has accumulated in the basin from previous storm events, then water input from this source may be available for a given flood event if hydrometeorological conditions permit snowmelt to occur. This chapter will describe the factors involved in the snow accumulation and ablation process and the techniques used to simulate these factors for flood runoff analysis. Two distinct types of floods are usually involved: rain-on-snow events, typical of the winter floods in the Cascade and Sierra Nevada mountains of the Western United States and the Appalachians in the East; and spring/summer floods - usually involving relatively little rain on the large rivers of the interior states, such as the Columbia, Missouri, and Colorado.

5-2. Physical Processes

a. Overview. Chapter 4 described the analysis of rainfall, leading to the estimation of basin-wide water excess that is potentially available for runoff. A special case of this hydrometeorological process occurs when air temperatures are cold enough to cause the precipitation to occur in its solid form and remain temporarily stored on the ground as snow. Once in place, a metamorphosis of the accumulated snow will eventually occur when heat energy is supplied from various sources. With enough heat energy, the snow will be transformed from a solid to liquid state and water will be available for runoff.

b. Precipitation, snowfall, and snow accumulation. In the middle latitudes, precipitation usually occurs as a result of the colloidal instability of a mixed water-ice cloud at temperatures below 32 °F. The formation of snow and, subsequently, rain in the atmosphere is a dynamic process. It has been observed that winter precipitation occurs initially in the form of snow crystals in subfreezing portions of clouds. As the snowflakes fall through the atmosphere, they later melt into raindrops when they fall through warmer, above-freezing air at lower elevations. The corresponding melting level air temperature of snowflakes falling through the atmosphere varies from 32 to 39 °F, but it is usually about 34 to 35 °F. Accordingly, on the earth's surface, snowfall

occurs at elevations higher than the melting level, while rainfall occurs at elevations lower than the melting level. The most significant determinant of the occurrence of rain or snow is the elevation of the melting level. This is particularly important in mountainous regions. Factors which influence the amount and distribution of precipitation in the form of snow and the snowpack water equivalent may be classified as being meteorologic and topographic. Meteorologic factors include air temperature, wind, precipitable water, atmospheric circulation patterns, frontal activity, lapse rate (vertical temperature profile), and stability of the air mass. Topographic factors include elevation, slope, aspect, exposure, forest, and vertical curvature. The crystalline form of newly fallen snow is most commonly hexagonal.

c. Snow metamorphosis. Freshly fallen snow exists in a clearly defined crystalline state, with sharply defined edges and abrupt points in each snow crystal. Metamorphosis of the snow occurs over time as the individual crystals lose their original distinct form and become rounded and bound together, ultimately into uniform, coarse, large ice crystals. This process is commonly called "ripening." This transformation may take place in as short a time period as several hours, but commonly involves a period of days or weeks in intercontinental areas with a large, deep snowpack.

(1) The specific gravity of snow (a dimensionless ratio) is commonly called the snow density (which properly would be mass per unit volume). The density (percent water equivalent) of the newly fallen snow is typically on the order of 10 percent, with variations of 6 to 30 percent dependent upon the meteorological conditions involved, primarily air temperature and wind. As metamorphosis occurs, density increases, reaching values of 45 to 50 percent for a fully ripe snowpack. A snowpack ripe for melt also contains a small amount of free water, on the order of 3 to 5 percent. A ripe snowpack is said to be "primed" to produce runoff; that is, when it contains all the water it can hold against gravity.

(2) The temperature of the snowpack varies as a factor in the metamorphosis process. In its early stages, the variation throughout the depth may be marked, from approximately 32 °F near the ground to subfreezing temperatures at shallower depths. As the snow ripens, a more isothermal pattern develops, and in its "ripe" condition the snowpack is completely isothermal and near 32 °F. The amount of heat required per unit area to raise the temperature of the snowpack to 32 °F is termed the "cold content" of the snow. This is expressed in terms of liquid water (produced at the surface by rain or melt) which,

upon freezing within the snowpack, will warm the pack to 32 °F.

d. Snowmelt. The process of melting snow involves the transformation of snow/ice from its solid form to liquid water through the application of heat energy from outside sources. While the latent heat of ice is established at 80 cal/g, this factor usually must be adjusted to actual snow conditions since the snowpack is not in the form of pure ice at 0 °C. The ratio of heat necessary to produce water from snow (and associated free water) to the amount required to melt the same quantity of ice at 32 °F is termed the “thermal quality” of the snowpack. For a fully ripe snowpack, the thermal quality can be on the order of 0.95 to 0.97.

(1) The rate of snowmelt is dependent upon the many different processes of heat transfer to and from the snow-pack, but it is also somewhat dependent upon the snow-pack condition. The relative importance of these processes varies widely seasonally, as well as with the day-to-day variation of meteorological factors. The heat transfer processes also vary significantly under various conditions of forest environment, exposure, elevation, and other environmental factors.

(2) The four major natural sources of heat in melting snow are absorbed solar radiation, net long-wave (terrestrial) radiation, convective heat transfer from the air, and latent heat of vaporization by condensation from the air. Two additional minor sources of heat are conduction of heat from the ground and heat content of rainwater.

(3) Solar radiation is the prime source of all energy at the earth’s surface. The amount of heat transferred to the snowpack by solar radiation varies with latitude, aspect, season, time of day, atmospheric conditions, forest cover, and reflectivity of the snow surface (termed the “albedo”). The albedo ranges from 40 to 80 percent. Long-wave radiation is also an important process of energy exchange to the snowpack. Snow is very nearly a perfect black body, with respect to long-wave radiation. Long-wave radiation exchange between the snow surface and the atmosphere is highly variable, depending upon conditions of cloud cover, atmospheric water vapor, nighttime cooling, and forest cover. Heat exchange by convection and condensation of heat and water vapor from or to the snow surface and the atmosphere is dependent upon the atmospheric air temperature and vapor pressure gradients, together with the wind gradient in the atmosphere immediately above the snow surface. These processes are particularly important under storm conditions with warm air advection and high relative humidity. In summary,

there is no one process of heat exchange to the snowpack that may be universally applied, but the relative importance of each of the processes is dependent on atmospheric, environmental, and geographic conditions for a particular location and a particular time or season.

5-3. Data Requirements, Collection, and Processing

a. Data requirements. Data required for snow analysis and simulation include those required for rain-only situations plus additional data necessary for the snow accumulation/snow melt processes involved. These include air temperature data and snow measurements as a minimum but could include windspeed, dewpoint, and solar radiation if energy budget computations are being performed.

(1) Air temperature data are quite critical in any modeling or analysis effort, since freezing level must be known during the snow accumulation process to distinguish between precipitation type in the basin. Temperature is also frequently (almost exclusively) used as an index to determine snowmelt. An additional parameter needed in modeling is the lapse rate, which must either be a fixed value or estimated from observed temperature readings. If calculated, temperature stations at different elevations are necessary.

(2) Snow data are collected in the form of snow water equivalent, frequently on a daily basis in the case of automated stations using snow pillows, or monthly in the case of manually read snow courses. Snow water equivalent data as applied to flood-runoff analysis would be needed as an independent variable for simplified analyses and seasonal runoff forecasting, and as data to assist in calibrating and verifying simulation models. Since snow stations may be the only source of high-elevation precipitation, they also can be used to help estimate basin-wide precipitation input to simulation or statistical models.

b. Data collection. The collection of precipitation data in areas subject to snow accumulation presents additional problems in gauging, due to considerations of gauge freezing, “capping” of the gauge by snow, and shielding of the gauge. Equipment and field procedures for such conditions are well documented (USACE 1956). The selection of appropriate precipitation, snow, and temperature gauges for analysis of a mountainous environment subject to snow conditions warrants careful consideration of vertical factors in addition to areal considerations used in rain-only situations, since the vertical distribution of precipitation and the vertical temperature profile must be

considered. Bearing on this consideration is the application involved; for simple indexing applications, for instance, a high-elevation snow gauge may be very important. For detailed simulation, a gauge placed in mid-elevations may be more important for defining the distribution of precipitation in the vertical direction and giving a field reference of snow conditions during critical times of snowmelt.

c. Data processing. There are no significant additional requirements for processing snow-related data as compared to nonsnow situations. Special treatment of monthly snow course data may be required if daily increments are to be estimated; this can be accomplished through correlation with a nearby station. Temperature is usually expressed in terms of daily maximum/minimum, or hourly data may be used. In the case of the former, the maximum/minimum data can be expressed as two separate stations, and model preprocessors apply weights to each as desired.

5-4. Simulating Snow Accumulation

a. Applications. Hydrologic engineering analyses involving snow typically require an estimate of snow water equivalent for the basin being studied as input into the runoff derivation. This estimate must directly or indirectly consider the process of snow accumulation and distribution, which includes factors such as the effects of geography and elevation in the distribution of snow and the accounting of the rain/snow threshold. The complexity of this determination can vary depending upon data availability and application, from simple estimates of a single basin value, to detailed simulation using a distributed formulation of the basin. Table 5-1

summarizes three possible approaches of varying complexity.

b. Watershed definition. Because temperature, and therefore elevation, play such an important role in defining the conditions of the basin during a precipitation event, the watershed being simulated needs to be defined with independent subunits. The most common approach is to divide the basin into zones or bands of equal elevation. On each band, precipitation, snow, soil moisture, etc. can be independently accounted for as illustrated in Figure 5-1. In a spatially distributed model, the configuration of computational nodes would likewise have to consider these elevation effects. Available models such as HEC-1 (USACE 1990a) and SSARR (USACE 1987) provide for the watershed definition to be established relatively easily. Simplifying assumptions, such as defining zone characteristics through generalized functions for the basin, are often employed. Such assumptions are not unreasonable since detailed information on subbasin definition is not likely available.

c. Simulation elements. Figure 5-2 illustrates the process that must be considered in simulating snow accumulation. For a given elevation zone or subbasin element and a given time period, these steps include: (1) find base temperature; (2) calculate lapse rate (fixed or variable); (3) calculate temperature at elevation of zone or subelement; (4) calculate zone precipitation; (5) get rain-freeze temperature; (6) calculate breakdown of rain versus snow; and (7) accumulate snow; recalculate snowline. There are no complex equations involved in this process, which is largely a detailed accounting process. The lapse rate is usually taken as a fixed input parameter (often 3.3 deg per 1,000 ft of elevation), but may be a specified or

Table 5-1
Alternatives For Estimating Snow Water Equivalent (SWE)

Approach	Possible Application	Comment
Simple estimate of SWE	1. Single event rain-on-snow computation 2. Forecasting in rain-dominated areas	Simple estimate based upon historical records. May be adequate where rain dominates
Detailed estimate of SWE, considering elevation distribution	Design flood derivation, snow-dominated basin	More detailed analysis of historical records
Simulation of snow accumulation through the accumulation season	1. Detailed design flood derivation 2. Forecasting water supply	Requires a continuous-simulation model

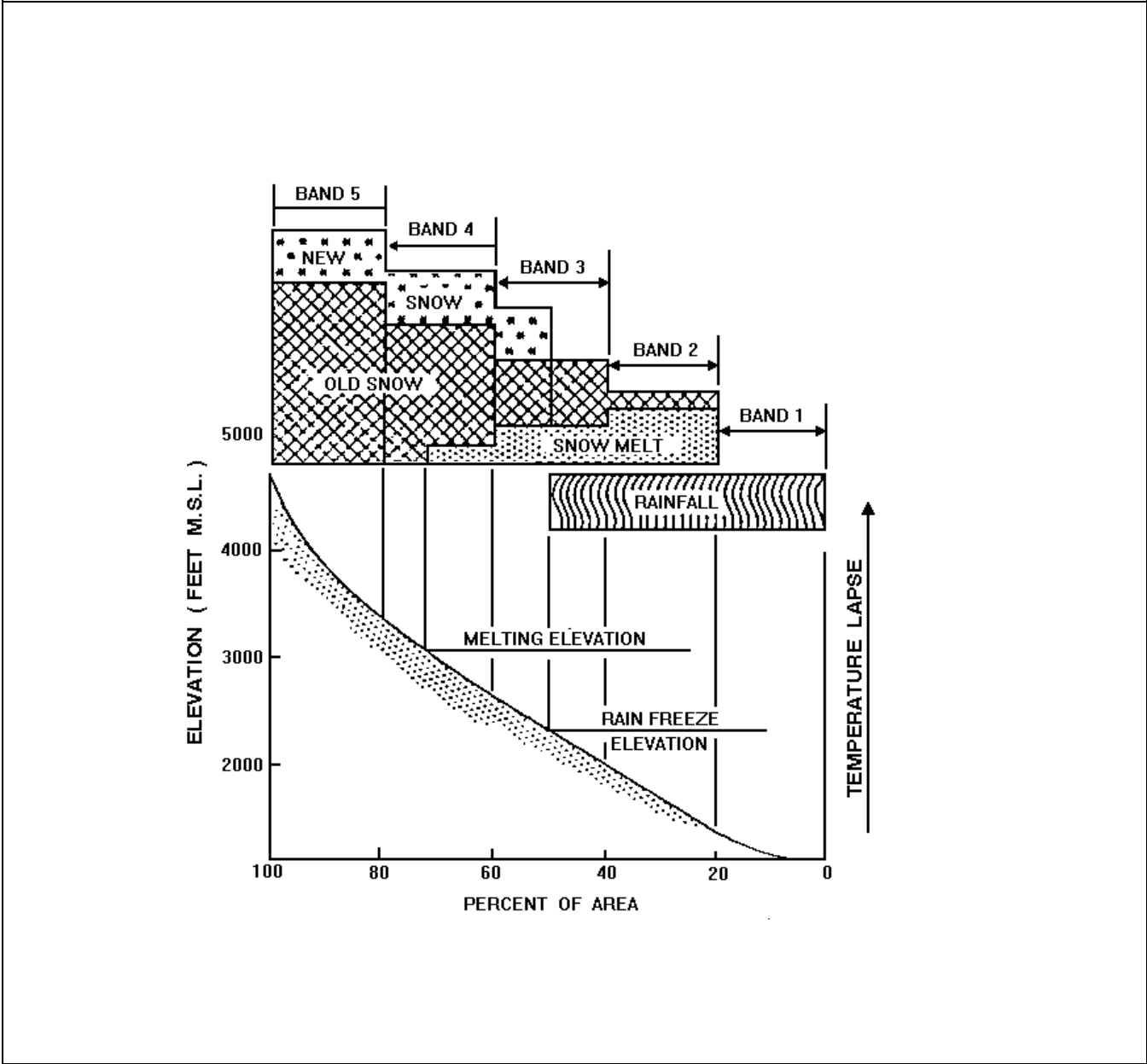

Figure 5-1. Illustration of distributed formulation of a watershed model using elevation bands

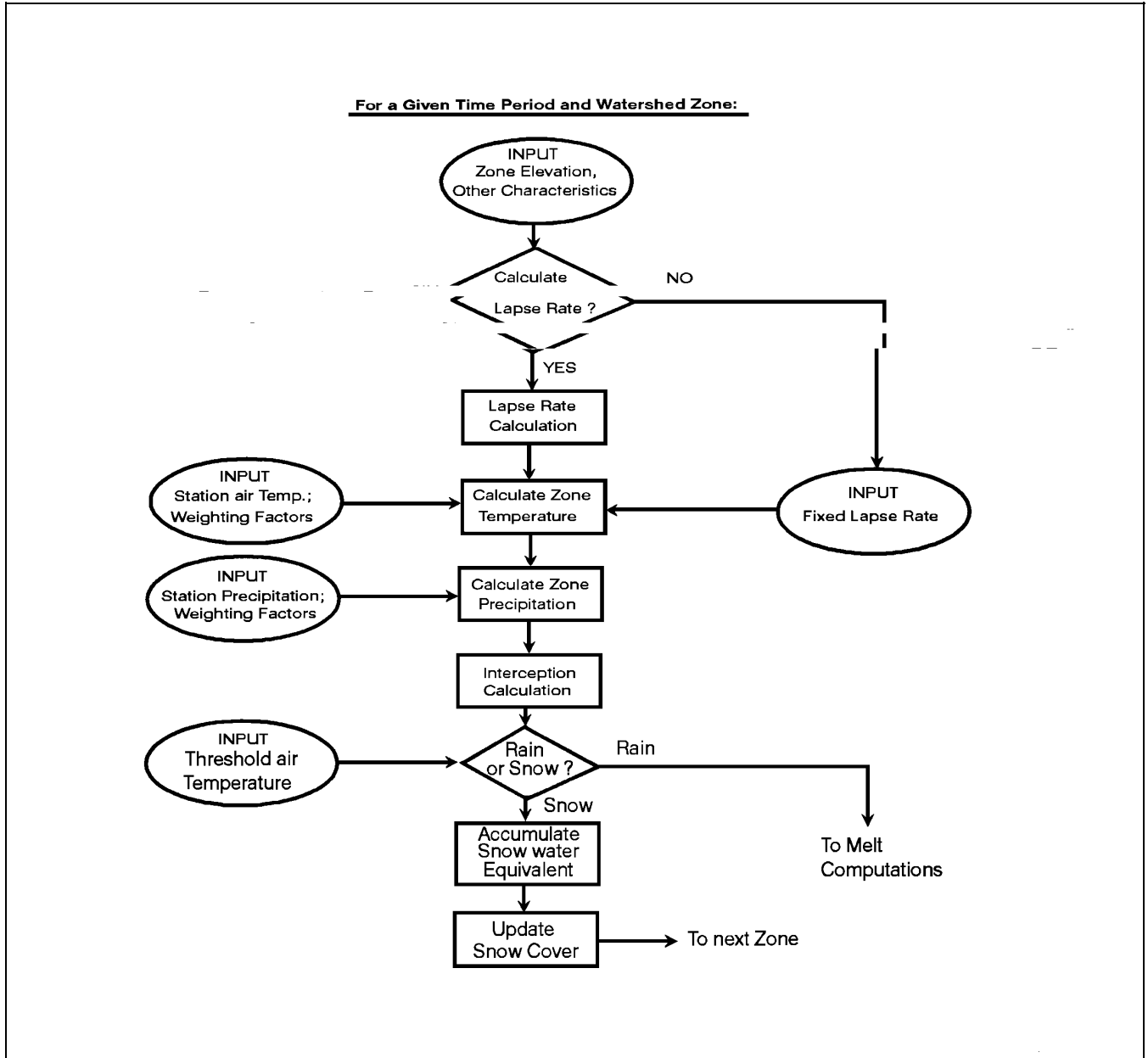

Figure 5-2. Illustration of snow accumulation simulation

calculated variable. The rain-freeze temperature is likewise usually a fixed value, usually around 34 °F.

d. Alternatives to simulation of snow accumulation. Various alternatives exist to a detailed accounting of snow accumulation, depending on the hydrologic regime involved and the application desired. For analyzing discrete rain-on-snow storm events, such as in design flood analysis, a simple estimate of snow water quantity at the (beginning) of the storm may be sufficient, particularly if the snowmelt contribution is relatively small compared to rain runoff. This may be based upon historical records of snow. In the Columbia basin, operational forecasting of spring snowmelt runoff employs simplifying assumptions of snow accumulation for most basins. In this case, the seasonal accumulation of snow is estimated through the use of multiple regression models using winter precipitation and snow as independent variables. Errors in this estimate are accounted for during the simulation of snowmelt by adjusting the model's estimate of snow based upon model performance and observed areal distribution of snow.

5-5. Simulating Snowmelt

a. Overview of applications and approaches. Numerous alternatives present themselves in determining the best approach for simulating snowmelt in flood-runoff analysis. These approaches range from simplified assumptions on discrete storm events to detailed simulation using energy budget principles and distributed definition of the watershed. The choice of methods is dependent upon the application involved, resources available, and data availability. Table 5-2 summarizes the options that are possible and how they tend to relate to given types of applications. A typical situation that might be encountered is that of calculating a hypothetical flood from specified rainfall, either of specified frequency or from a National Weather Station (NWS) hydrometeorological report. If the meteorological conditions are such that rainfall dominates and the duration of the storm is relatively short, it may be quite satisfactory to use a simple approach to estimating snowmelt (e.g., by establishing an antecedent water content by historical analysis then using an assumed rate of melt or a temperature index applied with a melt rate factor). The simulation of snow conditioning would not be required, since the assumption of a "ripe" snowpack prior to the storm could be assumed. On the other hand, the derivation of a design flood or the forecasting of flood runoff in a basin that is predominately snow would likely require a more detailed simulation of snow conditioning and snowmelt, perhaps

through the use of theoretical or empirical equations as described below.

b. Simulation of energy input. As discussed in paragraph 5-2d, the sources of heat energy that cause snowmelt involve several factors that can be difficult, if not impossible, to quantify and measure. In actual practice then, the theoretical relationships involved are reduced to empirically derived equations that have worked satisfactorily in simulation models. Two basic approaches are commonly used: the "energy budget" solution which employs simplified equations that represent key causal factors such as solar radiation, wind, heat from condensation of water vapor, etc.; and the "temperature index" solution which uses air temperature as the primary independent variable through the use of a fixed or variable "melt-rate factor." The latter solution is almost exclusively used in practical applications of forecasting and analysis.

(1) Energy budget solution. Although variations exist in the equations that have been developed to simulate snowmelt, those developed in the 1950's by the U.S. Army Corps of Engineers remain sound and serve to easily illustrate the basic principles involved. These were based on extensive field experiments coupled with theoretical principles, as discussed in the summary report, "Snow Hydrology" (USACE 1956). The several equations that were derived are also presented in EM 1110-2-1406, Runoff From Snowmelt, and have been used in several applications. The equations presented with abbreviated explanation below are described in detail in both of these documents.

(a) For snowmelt during rain, in which shortwave solar radiation is relatively unimportant and condensation melt is relatively high, the following equation (Eq 20, EM 1110-2-1406) applies:

$$M = (0.029 + 0.0084kv + 0.007P_r)(T_a - 32) + 0.09 \quad (5-1)$$

where

M = total daily snowmelt, in inches

k = factor representing the relative exposure of the basin to wind (for unforested areas, $k = 1$)

Table 5-2
Snowmelt Options¹

Application	Example	Basin Configuration		Snow Conditioning	Melt Calculation		
		Lumped	Distributed		Simplified ²	Temperature Index	Energy Budget
Single-event analysis-Rain-on-snow	Design floods in coastal mountains	Yes	Possibly	Assumed "ripe"	Possibly	Possibly	Possibly
Single-event analysis-Snow (plus rain)	Design floods in interior basins	Yes	Yes	Assumed "ripe"	No	Yes	Yes ³
Single-event forecasting-Rain-on-snow	Short-term flood forecasting	Yes	Yes	Optional	Possibly ⁴	Yes	No
Single-event forecasting-Snow (+ rain)	Short-term flood forecasting	Yes	Yes	Optional	No	Yes	No
Continuous simulation, any environment	Long-term flood/drought forecasting; Detailed analysis for design	No	Required	Required	No	Yes	Possibly
Macro simulation in small watersheds	R&D applications; analysis for detailed design; special applications	No	Required	Required	No	No	Yes

¹ Qualitative indicator shown for type of option that might typically be used for application. This is a guideline only. "Yes" or "No" indicates suggested option.

² Simplified approach might be to assume a constant or variable moisture input due to snowmelt.

³ Has been used for probable maximum flood (PMF) calculations in the Columbia basin.

⁴ Would be appropriate only in situations where snowmelt is small compared with rain.

v = wind velocity at the 50-ft height, in miles per hour

P_r = daily rainfall, in inches

T_a = mean temperature of the saturated air, in degrees Fahrenheit

The constants in the equation are based on field investigations. The factor 0.029 relates snowmelt due to longwave radiation to temperature, and the term 0.0084kv represents the effects of convection-condensation melt. The factor

0.09 accounts for melt from ground heat. If, for example, on a given day the average air temperature is 50 °F, rainfall is 3 in., and wind velocity is 20 mph in an unforested environment, then the melt components would be:

Solar radiation (long wave) - 0.5 in.
 Convection-condensation - 3.0 in.
 Rain - 0.4 in.
 Ground heat - 0.1 in.

 Total - 4.0 in.

This example illustrates the importance of the convection-condensation melt component, and the corresponding importance of wind, in a rain-on-snow situation. The importance of rain itself in producing melt is relatively small.

(b) For the case of snowmelt during rain-free periods, direct (short-wave) solar radiation must be accounted for. Several equations are developed in Snow Hydrology (USACE 1956) depending upon the degree of forest canopy involved. One, for partly forested areas (Eq 24, EM 1110-2-1406) is as follows:

$$M = k'(1 - F)(0.0040I_i)(1 - a) + k(0.0084v) \quad (5-2)$$

$$(0.22T_a + 0.78T_d) + F(0.029T_a)$$

where

M = snowmelt, in inches per period

k' = basin shortwave radiation melt factor. It depends on the average exposure of the open areas to shortwave radiation melt factor. It depends on the average exposure of the open areas to shortwave radiation in comparison with an unshielded horizontal surface

I_i = observed or estimated insolation (solar radiation on horizontal surface), in langleys

a = observed or estimated average snow surface albedo

k = basin convection-condensation melt factor, as defined above. It depends on the relative exposure of the area to wind

T_a = difference between the air temperature measured at 10 ft and the snow surface temperature, in degrees Fahrenheit. (Snow surface temperature can be assumed to be 32 °F)

T_d = difference between the dewpoint temperature measured at 10 ft and the snow surface temperature, in degrees Fahrenheit

F = estimated average basin forest canopy cover, effective in shading the area from solar radiation, expressed as a decimal fraction

The energy budget equation requires considerably more data than those previous so that its usage becomes limited in practical applications. One possibility, however, is in PMF derivations where variables such as insolation, albedo, etc. can be maximized through analysis of historical data (USACE 1956) and EM 1110-2-1406. Both of the equations presented are available in the HEC-1 (USACE 1990a) and SSARR (USACE 1987) computer programs. The generalized snowmelt equations also provide a useful method of estimating relative magnitudes of melt components. Table 5-3 presents melt quantities calculated from these equations for six hypothetical situations--three with rain, three without.

(2) Temperature index solution. Because of the practical difficulties of obtaining data needed for the energy budget equations, common practice is to simulate snowmelt by the "temperature index" solution, utilizing the basic equation

$$M = C (T_a - T_b) \quad (5-3)$$

where

M = snowmelt, in inches per period

C = melt rate coefficient that is often variable (discussion follows)

T_a = air temperature, in degrees Fahrenheit

T_b = fixed base temperature, near 32 °F

Given the numerous variables contained in the energy budget equations above, it can be seen that the employment of temperature only as an index to snowmelt results in further approximation and inaccuracy; yet, considering the other uncertainties involved - particularly in forecast applications - this does not usually preclude its use.

(a) The melt-rate factor, C , is of course an important key in the successful application of the temperature index equation. Assuming daily melt computation interval, this factor would be on the order of 0.02 to 0.04 in./degree per day when used with maximum air temperature and 0.04 to 0.10 in./degree per day when used with average air temperature. In clear-weather melt situations, this factor would typically increase as the snowmelt season progressed because of factors such as the decrease in albedo, increased short-wave radiation, etc. Because of

Table 5-3
Relative Magnitude of Snowmelt Factors

a. Assumed Conditions

Case	Description	Assumed Meteorological Conditions				
		T _a	T _d	I	R	V
1.	Clear, hot, summer day. No forest cover. Albedo = 40%	70	45	700	0.0	3
2.	Same as Case 1, 50% cloud cover	65	50	500	0.0	3
3.	Same as Case 1, fresh snow. Albedo = 70%	70	45	700	0.0	3
---	-----	--	--	--	--	--
4.	Heavy wind and rain, warm. No forest cover	50	50	0	3.0"	15
5.	Same as Case 4, but light rain, windy	50	50	0	0.5"	15
6.	Same as Case 5, but light wind	50	50	0	0.5"	3

T_a = Air Temperature, °F
T_d = Dewpoint Temperature, °F
I = Solar Insulation, langley
R = Daily rainfall, in.
V = Mean wind velocity, mph

b. Daily Melt Quantities

Case	Snowmelt Components, in.					Total Melt in.	Rain + Melt in.
	M _{sw}	M _{lw}	M _{ce}	M _r	M _g		
1.	1.68	0.00	0.46	0.00	0.02	2.16	2.16
2.	1.20	0.00	0.46	0.00	0.02	1.69	1.69
3.	0.84	0.00	0.46	0.00	0.02	1.32	1.32
-----	-----	-----	-----	-----	-----	-----	-----
4.	0.07	0.52	2.26	0.38	0.02	3.25	6.25
5.	0.07	0.52	2.26	0.06	0.02	2.93	3.44
6.	0.07	0.52	0.45	0.06	0.02	1.12	1.62

M_s = Short-wave radiation melt
M_{lw} = Long-wave radiation melt
M_{ce} = Convection/condensation melt
M_r = Rain melt
M_g = Ground heat melt

this, provision is usually made in simulation models to calculate this as a variable, perhaps as a function of accumulated runoff or accumulated degree-days of air temperature.

(b) The choice of base temperature depends upon the computation interval involved and the form of the temperature data. If maximum daily temperature is the input variable, then this factor would be higher than 32 °F, perhaps 40 °F. For a more frequent time interval, the factor would be at or near 32 °F.

(c) The possible range of the melt-rate factor can be illustrated by referring to the hypothetical cases presented in Table 5-3. Using the daily melt quantity calculated by the empirical energy budget equations and the temperatures assumed, the melt-rate coefficients calculated through Equations 5-1 and 5-2 would be as shown on Table 5-4. Table 5-4 generally confirms field experience regarding the range in variation of the temperature index melt-rate factor. For clear-melt conditions, the factor varies between 0.03 and 0.06 in./°F and increases as the snowmelt season progresses. For rain-melt conditions, the factor can exhibit wide ranging variations from 0.06 to 0.20, depending upon wind velocity and, to a lesser extent, the precipitation quantity. These factors would be higher if the temperature index used is the maximum daily temperature. In forecasting practice, the melt-rate factors are estimated through the process of calibrating a hydrologic model. Once established for known historic conditions, the factor can be modified by judgment to be applied to the design condition or forecast situation under consideration. Use of Equations 5-1 and 5-2 can be useful guides in this process. Additional discussion of the magnitude of the temperature index melt-rate factor can be found in the summary report (USACE 1956) and "Handbook of Snow" (Gray and Male 1981).

c. *Snow conditioning.* As discussed in paragraph 5-2c, snow conditioning or metamorphosis involves the warming of the snow pack to 32 °F, along with changes in density and character of the snow and the satisfying of liquid water deficiency. The first step in simulating this process is maintaining an accounting of the relative temperature of the snowpack below freezing as a function of time. This can be done through an index relation such as proposed by Anderson (1975):

$$T_s(2) = T_s(1) + F_p (T_a - T_s(1)) \quad (5-4)$$

where

T_s = index of the temperature of the snow pack

T_a = temperature of the air

F_p = factor, varying from 0 to 1, representing the relative penetration of the air temperature into the snowpack

If F_p is close to 1.0, the snow temperature will remain close to that of the air; thus, high values would be appropriate for a shallow snowpack. For a deep snowpack, a low value of F_p will result in a slow cooling or warming of the snow. The factor T_s is limited to a value of 32 °F.

(1) Once a snow temperature index is established for a computation period, the cold content (inches of water required to raise the snowpack to 32 °F) can be calculated through an equation such as:

$$CC(2) = CC(1) + C_r(T_a - T_s(2)) \quad (5-5)$$

Table 5-4
Relative Magnitude of Melt-Rate Factors
(Refer to Table 5-3 and Equations 5-1 and 5-2)

Case	T_a	T_b	Melt	C in./°F	Comment
1	70	32	2.16	0.057	Low albedo, high SWE
2	65	32	1.69	0.051	Case 1, cloud cover
3	70	32	1.32	0.035	Case 1, fresh snow
4	50	32	3.25	0.181	Heavy rain, windy
5	50	32	2.93	0.163	Light rain, windy
6	50	32	1.16	0.064	Light rain, light wind

where

CC = cold content (inches of water required to raise the snowpack to 32 °F).

C_r = factor which converts the increment of temperature differential $T_a - T_s$ to an increment of cold content differential

The value of C_r might typically range from 0.01 to 0.05 with higher values associated with late winter or early spring season. This factor is typically made a variable in simulation models by relating it to calendar periods or to a cumulative temperature index function.

(2) The other factor important in simulating snowmelt is the liquid water deficiency of the snow. This is usually taken as a constant percentage of the water equivalent of the snowpack on the order of 3 percent. When melt occurs, or rain falls upon the snowpack, the water generated must first be applied to satisfying the cold content and liquid water deficiency before water is available to enter the ground.

d. Snow accounting. As snowmelt progresses, the elevation of the snowline moves upward and the areal snowcover of the basin decreases. An accounting of this is necessary to be able to differentiate between snow-free and snow-covered areas which have different hydrologic characteristics; and determine the elevation, of the snowpack, for calculating air temperature for indexing melt. A second computation, either associated with snow cover or independent, is the accounting of the remaining snow water equivalent of the snowpack.

(1) If the basin has been configured into zones of equal elevation as described in paragraph 5-4b, the accounting of snow cover and quantity can be done on a zone-by-zone basis. One assumption that can be made is to make the zone homogeneous with respect to elevation and either 100 percent snow-covered or snow-free. This

assumption may require a large number of zones for adequate basin representation. Even with a large number of zones, the abrupt changes in the snowline can occur as a zone changes from snow-covered to snow-free. Because of this, some models provide an ability to simulate a gradual transition within the zone.

(2) An alternative to the distributed approach in accounting for snow during melt is to employ a snow-cover depletion curve in conjunction with a "lumped" watershed configuration. A snow-cover depletion curve describes the basin's snow-covered area as a function of accumulated snow runoff as a percent of seasonal total. Studies have shown this relationship to be of relatively uniform shape for a basin. Using historic field and satellite information, a pattern curve can be developed for a basin. This does not have to be followed precisely in actual application if flexibility exists in the program to make adjustments, for instance based upon real-time satellite observations of snow cover. While the snow-cover depletion curve yields an accounting of snow cover, this method still needs to employ an independently derived estimate of expected total basin snow water equivalent (SWE). The typical approach is to use multiple regression procedures as noted in paragraph 5-4d. The accounting of current remaining SWE during the melting of the snowpack is simply a process of subtraction. Adjustments to the estimates of SWE will likely be required, based upon model performance in simulating runoff.

e. Simulation elements. Figure 5-3 illustrates the process of simulating snowmelt in a simulation model. For a given time period and subbasin element, these include: (1) rain: is this a dry or wet melt calculation? (2) temperature, lapse rate, elevation of zone, etc.; (3) elevation of snow; (4) calculate temperature at zone pertinent to indexing; (5) melt; (6) type of melt computation; (7) other melt factors as necessary; (8) updated snow condition status; (9) water available for melt; and (10) updated snowline and SWE.

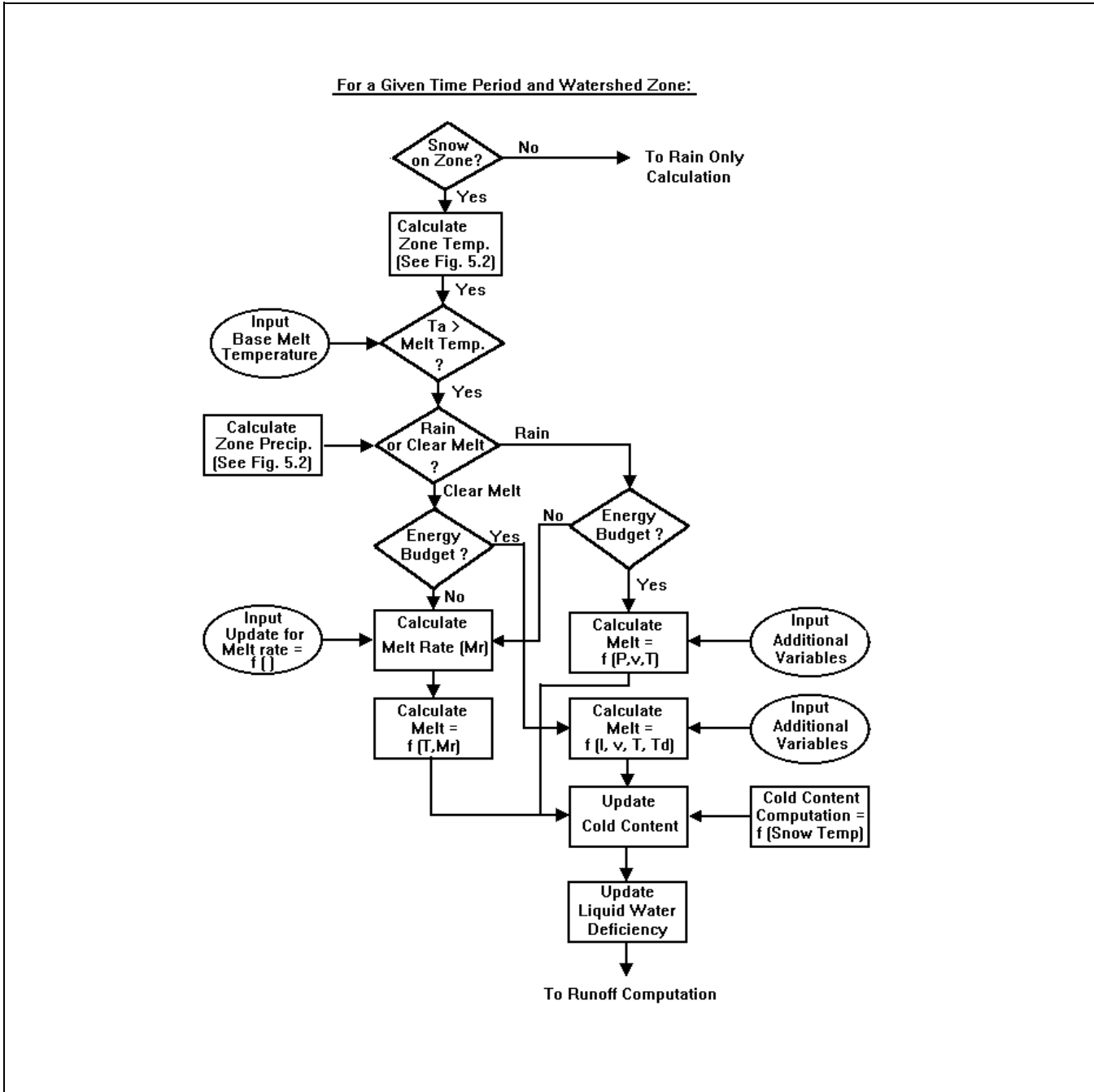

Figure 5-3. Illustration of snowmelt simulation

Chapter 6 Infiltration/Loss Analysis

6-1. General

a. Role of infiltration/loss computations in flood-runoff analysis. This chapter describes the methods typically available for computing the time history of direct runoff volume due to a single rainfall event. This is determined by subtracting from the rainfall hyetograph the losses due to interception, surface storage, and soil infiltration (Figure 6-1). The rainfall excess is routed to the subbasin outlet, usually by unit hydrograph or kinematic wave techniques, and combined with base flow to obtain the subbasin hydrograph.

b. Physical process. Soil infiltration and surface loss of rainfall involve many different processes at different scales of observation. The most basic of the processes is the infiltration of water into an "ideal" soil, a soil of uniform properties and infinite depth as shown in Figure 6-2. Initially, the soil is assumed to have a uniform water content. The initial water content or an initial condition related to the water content must be specified for any of the methods which are used for single rainfall event analysis. At the commencement of rainfall, water is infiltrated until the rainfall exceeds the capacity of water to be absorbed by the soil. At this point, the surface becomes saturated and rainfall in excess of the soil infiltration capacity is assumed to be runoff. As the volume of infiltrated water increases, the infiltration capacity of the soil decreases to a minimum rate equal to the soil's saturated hydraulic conductivity. The saturated hydraulic conductivity is a proportionality constant between hydraulic gradient and flow in Darcy's law for saturated flow in porous (soil) media and is assumed to be a characteristic of the soil.

(1) Theoretically, the transport of infiltrated rainfall through the soil profile and the infiltration capacity of the soil is governed by Richards' equation (Richards 1931 and Eagleson 1970). Richards' equation is derived by combining an unsaturated flow form of Darcy's law with the requirements of mass conservation. Solutions to Richards' equation show an exponential decrease of infiltration capacity with cumulative infiltration. Conceptual or empirical loss-rate equations attempt to duplicate this in computing rainfall excess.

(2) The predictions of infiltration by Richards' equation may at best be an approximation to actual field losses

because the ideal soil model does not correspond particularly well to field conditions. The deviations occur for several reasons: (a) the soil is heterogenous, usually layered and of finite depth; (b) the soil matrix is not an inert structure but is continually being affected by chemical and biologic processes; (c) surface losses and cover have a major impact on the available excess; and (d) the ideal soil model is a gross approximation to the dynamics of direct runoff production. Consider the impact of these additional processes on rainfall loss rates. Soil heterogeneity makes both the formulation of a physical model and the estimation of model parameters much more complicated. Formulating the equations of fluid motion in a heterogenous, layered soil is a difficult problem. The equations could be formulated, but estimating the parameters of the model, such as soil hydraulic conductivity, is totally impractical given the information typically available to the engineer. Furthermore, the detail needed to capture the small scale changes of soil properties is impractical. At best, some average estimate of soil properties for a relatively large area, a lumped approach to modeling, must be employed to model infiltration.

(3) Far from being inert materials developed strictly from the weathering of bedrock, soils owe their properties to the chemistry of rainwater, the chemical properties of the parent material, organic matter content and the presence of roots and burrowing animals. The chemistry of water is important because it can affect the shrink/swell potential of clays and the osmotic pressures within the soil. Clay soils may shrink and crack resulting in a desiccated surface which results in infiltration capacities far in exceedance of anything that would be expected from a material with a clay's saturated hydraulic conductivity. The hydraulic conductivity of the soil, being inversely proportional to water viscosity, is sensitive to the water temperature. The soil porosity, the ability to hold water, increases with the organic matter content. Burrowing animals and decaying tree roots create what has been termed "macropores" that are very effective in conveying water.

(4) Surface losses are categorized as being due to interception, depression, and detention storage. Interception storage results from the absorption of rainfall by surface cover such as plants and trees. Depression storage results from micro- and macrorelief depressions in the surface topography that store water which eventually infiltrates or evaporates. Also a function of topography, detention storage acts as minireservoirs, increasing the retention time of overland flow and providing more opportunity for infiltration.

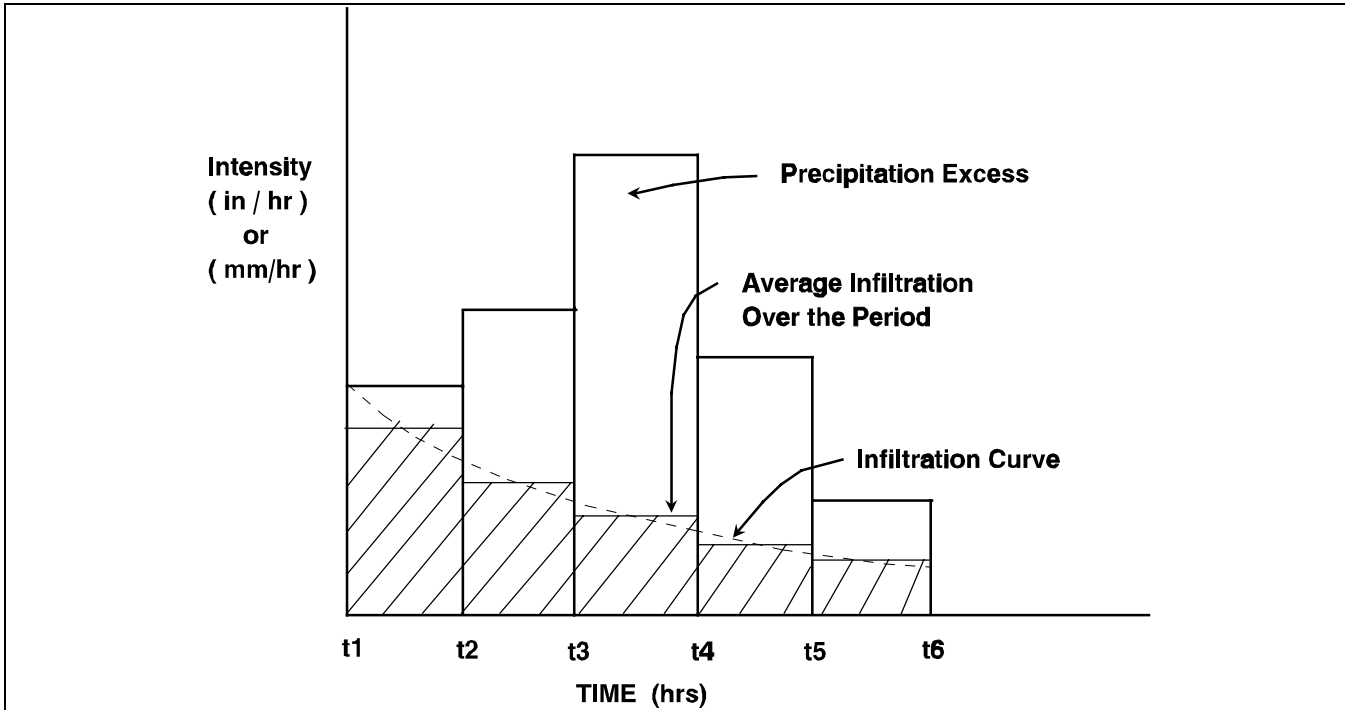

Figure 6-1. Loss rate, rainfall excess hyetograph

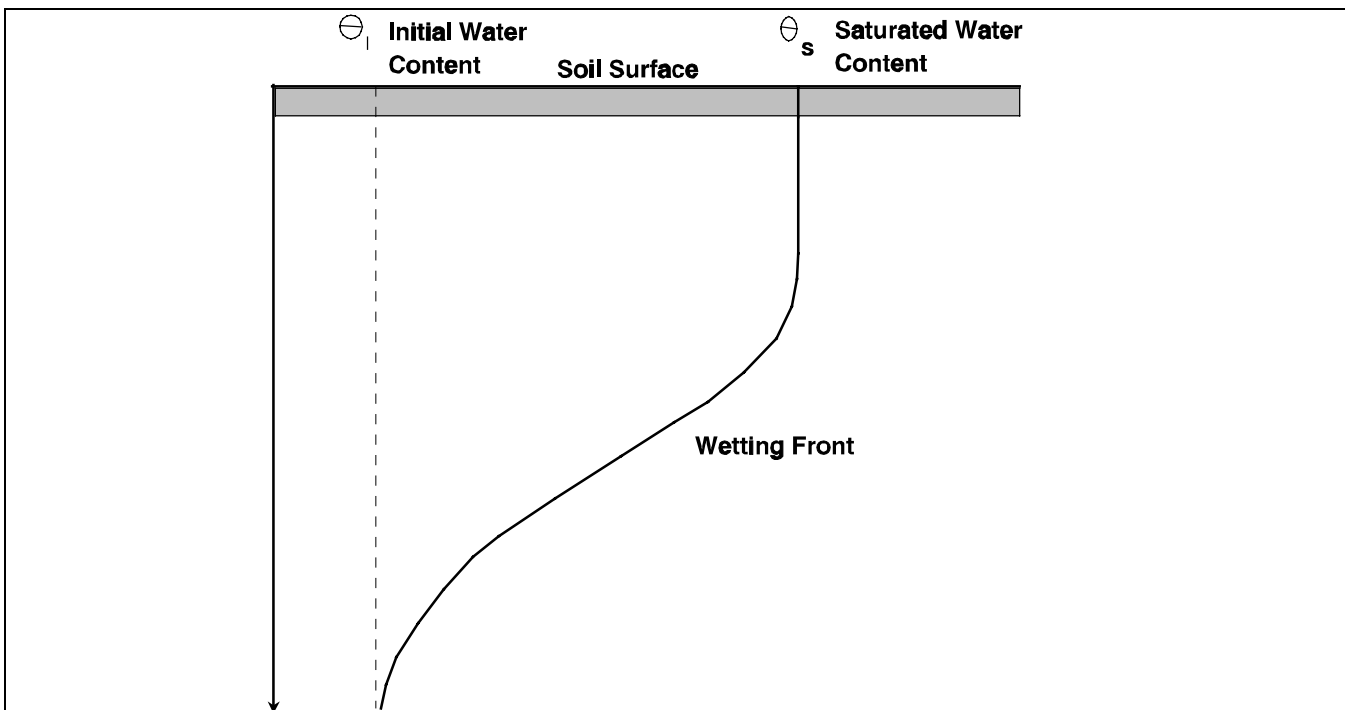

Figure 6-2. Wetting front in ideal soil

(5) Surface cover also increases loss rates by delaying overland flow. In addition, surface cover impacts on rainfall losses by protecting the soil surface from the impact of rainfall, preventing the formation of surface crusts that decrease the hydraulic conductivity of the soil surface.

(6) The extent to which surface conditions affect rainfall excess is a function of land use. Forested areas exhibit the greatest surface losses because of their well-developed canopies and significant surface storage provided by surface litter. Range land is less effective in storing water because of sparser cover. The presence of grazing further reduces cover and increases runoff potential. Bare surface conditions in agricultural areas can potentially result in relatively high runoff rates due to crusted surfaces formed from rainfall impact. Management practices, such as contour plowing or mulching, have been employed to protect the soil or store overland flow. Urban area runoff increases in proportion to the amount of impervious area and how this area is connected to outflow points by the drainage system.

(7) Even if the ideal soil model could account for all the processes mentioned so far, there would still be the problem of accounting for the dynamics of direct runoff production. Direct runoff can be simulated by either the Horton or Hillslope process (Ward 1967). The Horton process, named for the famous hydrologist, corresponds more closely to the ideal soil model (Figure 6-3). In this process, overland flow results when all surface storages are filled and the rainfall rate exceeds the infiltration rate. Overland flow that does not infiltrate along the flow path to a channel results in direct runoff. The potential for infiltration along the flow path is not accounted for when an average soil property is used to calculate runoff in an ideal soil model.

(8) The Horton process is most likely to be important in urban and agricultural areas where the infiltration capacity of soils is relatively small due to cultural activities. However, overland flow, the cornerstone of the Horton process, rarely occurs in forested soils. Forest soils generally have extremely high infiltration capacities in the upper horizon due to a well-developed surface cover and extensive tree root structure. In these soils, direct runoff is due to the Hillslope process. In this process, direct runoff results due to the mixture of surface and subsurface flow. Prior to direct runoff, the initial watershed moisture conditions are characterized by drier conditions at the top of the hillslope and wetter conditions at lower elevations near the channel (Figure 6-4). At the

commencement of rainfall, water infiltrates at the top of the hillslope and moves vertically through the soil until it reaches a low conductivity soil zone. Lateral movement of the infiltrated water occurs along the lower conductivity layer as either saturated or unsaturated flow until it seeps out to the surface nearer the bottom of the hillslope. At this point, the infiltrated water combines with overland flow generated by rainfall on the initially wetter areas near the stream channel. These areas are termed variable source areas because as the rainfall continues they grow in size, comprising more of the watershed area. Observations have shown that the subsurface movement of water down the hillslope combined with overland flow from the source areas is the flood mechanism in forested areas. In some respects, the apparent rainfall excess in a flood hydrograph in a forested area is a combination of interflow, subsurface flow, and overland flow.

(9) In summary, the rainfall infiltration/loss process is complex and affected by many factors. Soil properties are important, but chemistry of the water, biologic activity, soil heterogeneity, and surface cover modify the soil's infiltration capacity. Surface cover and topography also are involved in losses by intercepting, storing, and detaining rainfall. Finally, the dynamics of the rainfall-runoff process are important in determining the volume of rainfall available for direct runoff. Even though excess may be generated at some point in an agricultural or urban area, some of this excess may infiltrate as overland flow traveling to a channel. In forested areas, flow that has infiltrated is a major contributor to direct runoff.

c. Approaches to infiltration/loss analysis. Watershed modeling for flood prediction is an exercise in finding adequate estimates of watershed properties over watershed size areas. The methods used to model infiltration/loss rates reflect this approach.

(1) The methods can be categorized as physically based, conceptual, or empirical. The physically based models, such as Green and Ampt, are based on simplified solutions to the Richards equation. This approach was developed for three reasons: (a) the solution of the Richards equation is difficult and not justified given that this equation is, at best, only a rough approximation of the actual field infiltration; (b) a simplified solution still produces the exponentially decreasing relationship between infiltration capacity and cumulative infiltration; and (c) the parameters of the methods can be related to soil properties that can be measured in the laboratory, such as porosity and hydraulic conductivity.

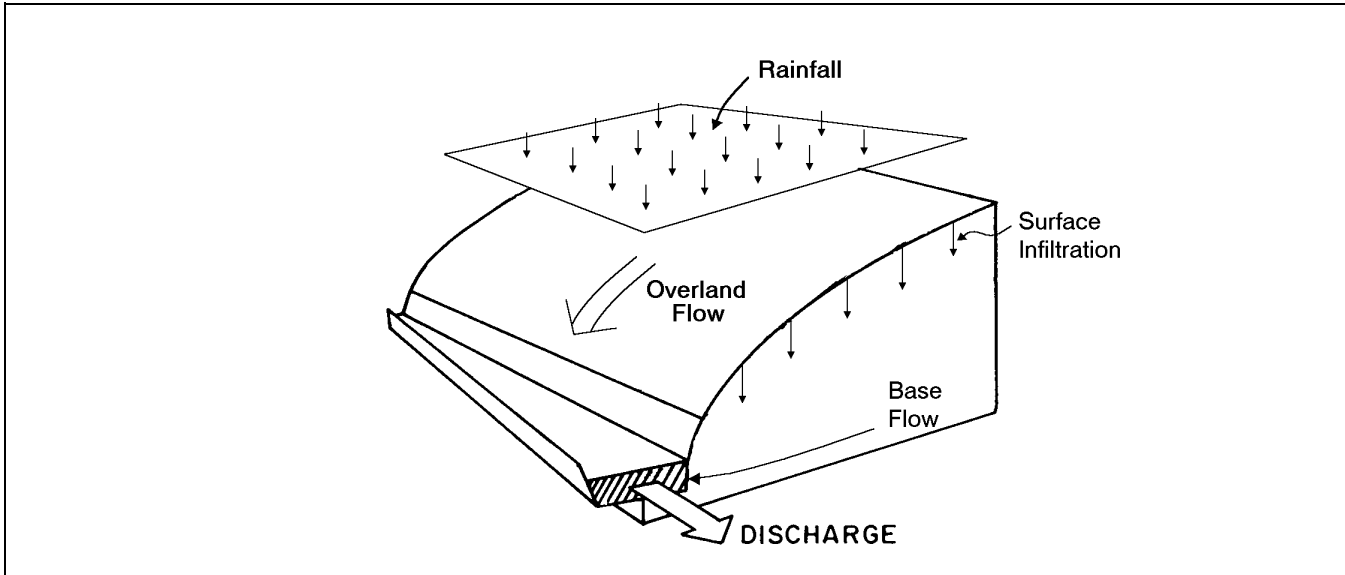

Figure 6-3. Horton runoff

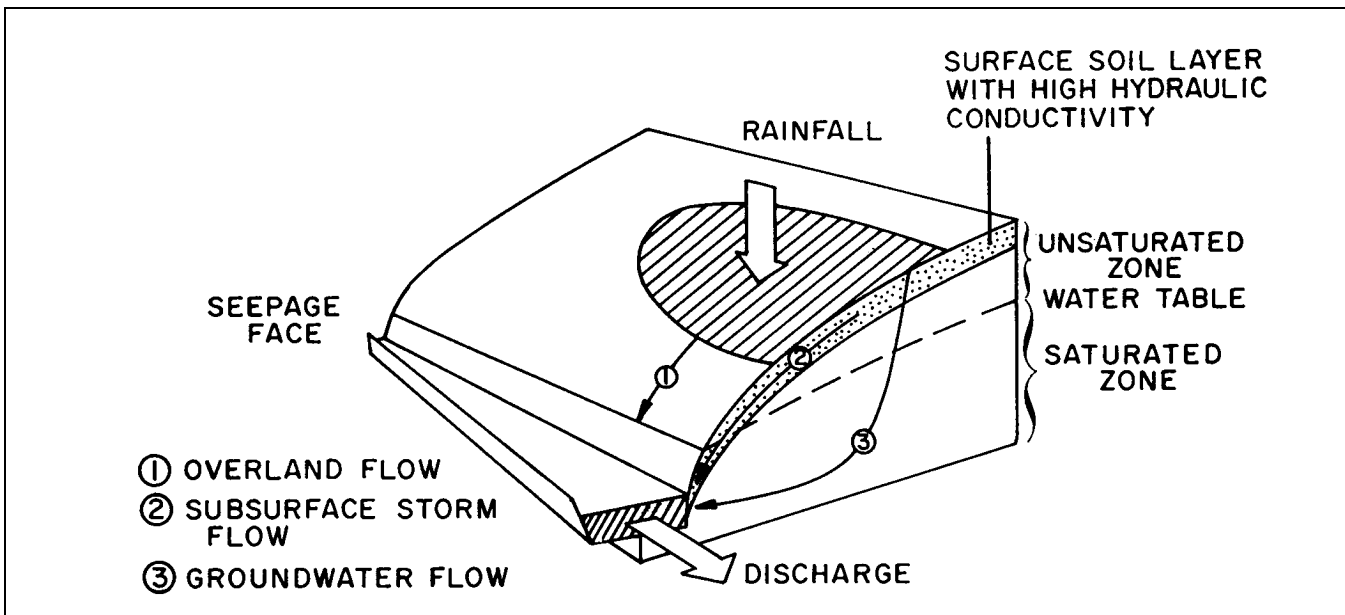

Figure 6-4. Hillslope process

(2) Methods such as the Holtan loss rate conceptually mix parameters which have a physical basis such as a deep percolation rate with empirical ones such as an exponent which controls the infiltration capacity as a function of storage. Empirical methods, such as the Soil Conservation Service (SCS) curve number (CN), are based on correlating parameters estimated from rainfall-runoff records to factors affecting loss rates such as soil type and surface cover. The initial and constant loss rate method can be considered either an empirical method or a gross representation of an infiltration curve. Each of these methods have been applied in watershed models and will be discussed in the following sections.

6-2. Gauged versus Ungauged Parameter Estimation

a. Parameter estimation techniques generally are categorized by application to gauged or ungauged analysis. In the description of loss rate methods, parameter estimation is discussed only with regard to estimating parameters from the physical characteristics of the watershed. These estimates can be useful in an ungauged or gauged situation. In an ungauged situation, physical characteristics may be the only information available for estimating parameters.

b. Gauged estimation procedures are used to estimate model parameters, including loss rate parameters, from rainfall-runoff records. The basic element of a gauged estimation is to utilize an “optimization” algorithm to choose model parameters so that some measure of the difference between observed and predicted hydrographs is minimized. This approach to parameter estimation is essentially a regression analysis, as pointed out by Dawdy, Lichty, and Bergman (1972). An important principle of regression analysis is parsimony, i.e., inclusion of the minimum number of parameters in the model that are needed to explain the data. In this respect, a simple two-parameter loss rate method, such as the initial and constant loss rate method, is probably adequate because it is parsimonious. Experience has shown that simple empirical methods with a minimum number of parameters do a satisfactory job when simulating observed hydrograph parameters.

c. Although not as parsimonious as simple empirical methods, methods with physically based or measurable parameters, such as the Green and Ampt method, can be advantageous in gauged analysis. The advantage stems from the ability to place bounds on the values of these parameters. The bounds can be applied using two different approaches when applying an optimization procedure.

One approach would be to evaluate whether or not the derived parameter estimates are within a reasonable range based on the physical characteristics of the watershed. A second approach is to constrain the parameter values to a reasonable range within the optimization. The second approach may prove difficult because of errors in rainfall-runoff data which dictate that parameters assume unrealistic values. Constraining the parameters may prevent a reasonable prediction of observed runoff.

d. A reasonable procedure to follow when applying a physically based loss rate method in a gauged analysis is to only perform parameter estimation with a maximum of two parameters. Additional parameters in the method should be estimated based on the physical characteristics of the watershed. Certainly, optimized parameters will have estimated values which are not reasonable due to observation errors. However, over a number of events, the errors should balance resulting in an acceptable estimate of loss rate parameters. Acceptance can be based on what seems reasonable from watershed characteristics.

6-3. Antecedent Moisture Conditions

a. The application of the methods discussed requires an estimation of the antecedent moisture condition (AMC) of the watershed surface cover and soils. Unfortunately, there is no simple answer as to how the AMC might be established. The approaches to use are a function of the intended application. Different approaches may be used depending upon whether individual or design events are being simulated or a gauged or ungauged analysis is being performed. Consider the simulation of individual events. The gauged analysis is straightforward, with the AMC used as another parameter that is adjusted to improve correspondence between the observed and predicted hydrograph. Ungauged analysis is much more difficult in that some methodology must be developed to determine AMC. The usual technique is to rely on an antecedent precipitation index (API) which is presumably based on regional information. API is a poor indicator of AMC due to various factors, most notably the impact of weather conditions on evapotranspiration. However, it's the only indicator usually available.

b. Estimation of AMC for design events depends on the type of event. AMC for probability-based design storms might be based on calibration to a gauged or regional discharge or volume frequency curve. In contrast, AMC (and in general loss rates) determination for deterministic design events such as the probable maximum precipitation is set by policy.

c. Certainly, the techniques for establishing AMC are varied and subject to some argument. When gauged information is not available, reliance on regional information is essential in establishing an AMC. Otherwise, the engineer may be forced to assume a conservative estimate for this parameter.

6-4. Surface Loss Estimation

a. Rainfall losses are due to both surface storage and soil infiltration. In the field, the surface storage and infiltration of rainwater are dynamically interconnected. The interconnection occurs primarily via surface depression and detention storage. Detention storage increases infiltration rate by adding a small (less than an inch) pressure head to the wetting front. This additional head is insignificant when compared to the suction head which drives soil infiltration. Detention storage increases apparent infiltration by delaying surface flow and providing more catchment retention time for water to infiltrate. In general, these effects are minor when compared to the problem of estimating the magnitude of surface loss and the in-situ capacity of soils to infiltrate water. Consequently, the typical approach is to separate these two contributions to rainfall loss unless surface losses are empirically included in the loss rate method. For example, the SCS curve number method includes surface losses directly into the method.

b. Surface loss is a function of land use and differs greatly between forested, agricultural, and urban areas. According to Viessman et al. (1977), interception of rainfall by surface cover is greatest for a forest and decreases for agricultural and urban land uses. Schomaker's (1966) measured values of interception for a spruce forest were 30 percent of the annual rainfall and for a birch forest were 9.5 percent of annual rainfall. Horton (1919) reported that the interception for rainfall events greater than 0.25 in. is approximately 25 percent of the total rainfall. The Viessman et al. (1977) conclusion from this information is that interception for forested regions is approximately 10 to 20 percent of the total precipitation, at least for rainfall events less than 2.0 in. In general, one should not expect interception losses to exceed 0.5 in. for a particular rainfall event.

c. Agricultural watershed surface losses are a function of crop development and management practice. Interception of rainfall by crops was computed by Linsley, Kohler, and Paulhus (1975) using equations developed by Horton (1919). They found that for a storm depth of 1.0 in., the interception ranged from 3 to 16 percent for small grain crops such as wheat and milo. This

compares well to the study by Schomaker (1966), since interception by these crops should be less than that of a forest due to the smaller leaves and sparser cover provided by these crops.

d. Detention storage in agricultural areas is strongly affected by the time since tillage occurred and the overall management practice. Linden (1979) used random roughness and land surface slope in microrelief models to predict depression storage due to tillage (note random roughness is essentially a measure of the variation of soil heights from the surface plane). He predicted that depression storage could be as high as 0.5 in. immediately after tillage. The depression storage will decrease with time after tillage due to the impact of rainfall. Linden's results do not account for increased storage capabilities due to management practice such as contour plowing. Horton (1935) estimated that detention storage for agricultural lands, natural grass lands, and forests range from 0.5 to 1.5 in.

e. Surface losses in urban areas differ for open and impervious areas. Interception losses for open areas (lawns, parks etc.) can probably be considered of the same magnitudes as forest or pasture land. However, the depression storage in the open areas is probably not as great as in natural areas because grading has taken place and there is probably less surface litter. The surface loss for impervious areas is small and usually taken as 0.1 to 0.2 in. Table 6-1 summarizes the surface losses that can be used for each land use type. The values listed in Table 6-1 are a suggested range based on previous research work and experience. If these values are not in line with local experience of a particular watershed, the modeler should by all means use any local information.

6-5. Infiltration Methods

a. *Green and Ampt.* The Green and Ampt method is explained and illustrated in detail below.

(1) Method development. The Green and Ampt (GA) method (Mein and Larson 1973) assumes the same simple soil model and initial conditions as that of the Richards equation, a uniform soil profile of infinite extent, and constant initial water content. As the water content at the soil surface increases, the method models the movement of the infiltrated water by approximating the wetting front with a piston type displacement (Figure 6-5).

(a) The piston displacement model, as originally developed, must be modified to account for surface losses and variable rainfall rates (time varying surface moisture

Table 6-1
Surface Losses

Interception Losses Agricultural Areas		
Crop	Height ft.	Interception in.
Corn	6	0.03
Cotton	4	0.33
Tobacco	4	0.07
Small grains	3	0.16
Meadow grass	1	0.08
Alfalfa	1	0.11

(from Linsley, Kohler, and Paulhus 1975)

Forest Areas (from Viessman et al. 1977)
10-20% total rainfall, maximum 0.5 in.

Detention Storage (from Horton 1935)

Agricultural Areas (Depending on time sense tillage)	0.5 - 1.5 in.
Forests/Grasslands	0.5 - 1.5 in.

Total Surface Loss

Urban Areas Open Areas	0.1 - 0.5 in.
Impervious Areas	0.1- 0.2 in.

conditions). The surface loss is modeled for an initial loss as follows:

$$r(t) = 0 \quad \text{for} \quad P(t) \leq I_a \quad t \geq 0 \quad (6-1)$$

$$r(t) = r_o(t) \quad \text{for} \quad P(t) > I_a \quad t \geq 0 \quad (6-2)$$

where

$P(t)$ = cumulative precipitation over the watershed

$r(t)$ = rainfall intensity adjusted for surface losses

t = time since the start of rainfall

$r_o(t)$ and I_a = depth of surface loss assumed to be uniform over the watershed

The cumulative infiltration loss is calculated by the GA method:

$$I = \frac{S_f}{[(i/K) - 1]} = \frac{KS_f}{[(dl/dt) - K]} \quad i > K \quad (6-3)$$

where

$dl/dt=i(t)$ = infiltration rate

K = soil's hydraulic conductivity

S_f = product of the wetting front suction, h_f , and the soil volumetric deficit at the beginning of the storm

$\Delta\theta$ and I = cumulative infiltration

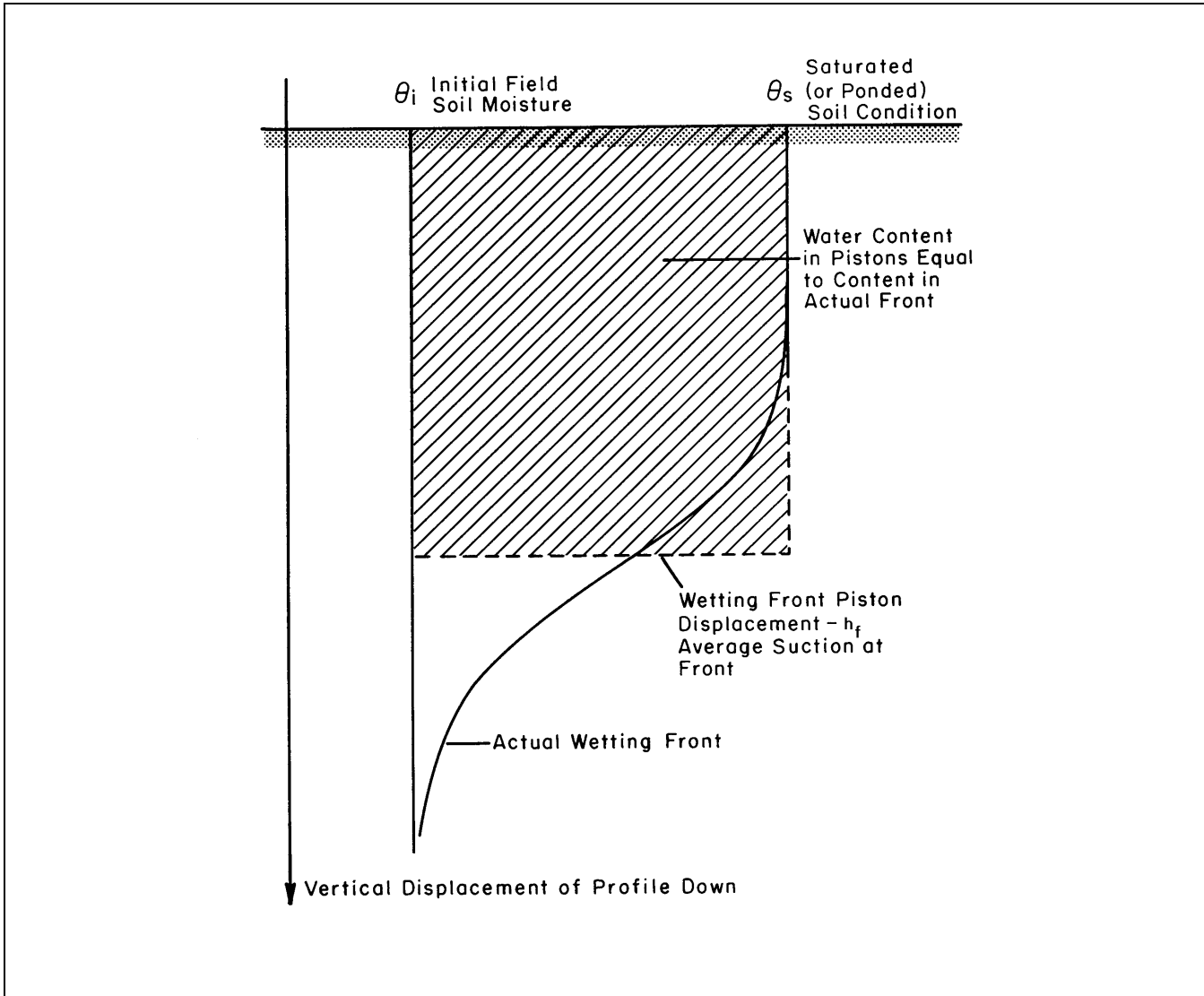

Figure 6-5. Green and Ampt piston wetting front

The GA equation as originally developed, is only strictly applicable to a uniform moisture condition at the soil surface or, in the case of rainfall infiltration, a ponded surface condition. Modifications were made as suggested by Mein and Larson (1973) and Morel-Seytoux (1980) to use the GA equation for unponded surface conditions and variable rainfall rates. In the absence of ponding, infiltration is estimated for any period by (Figure 6-6):

$$\Delta I = I_j - I_{j-1} = \frac{S_f}{(r_j/K) - 1} - \sum_{i=1}^{j-1} r_i \Delta t_i \quad r_j \geq K \quad (6-4)$$

where

I_j and I_{j-1} = cumulative depth of infiltration at the end of time period j and $j-1$

r_j = average rainfall rate over the period Δt_j

ΔI = potential depth of water infiltrated during the period

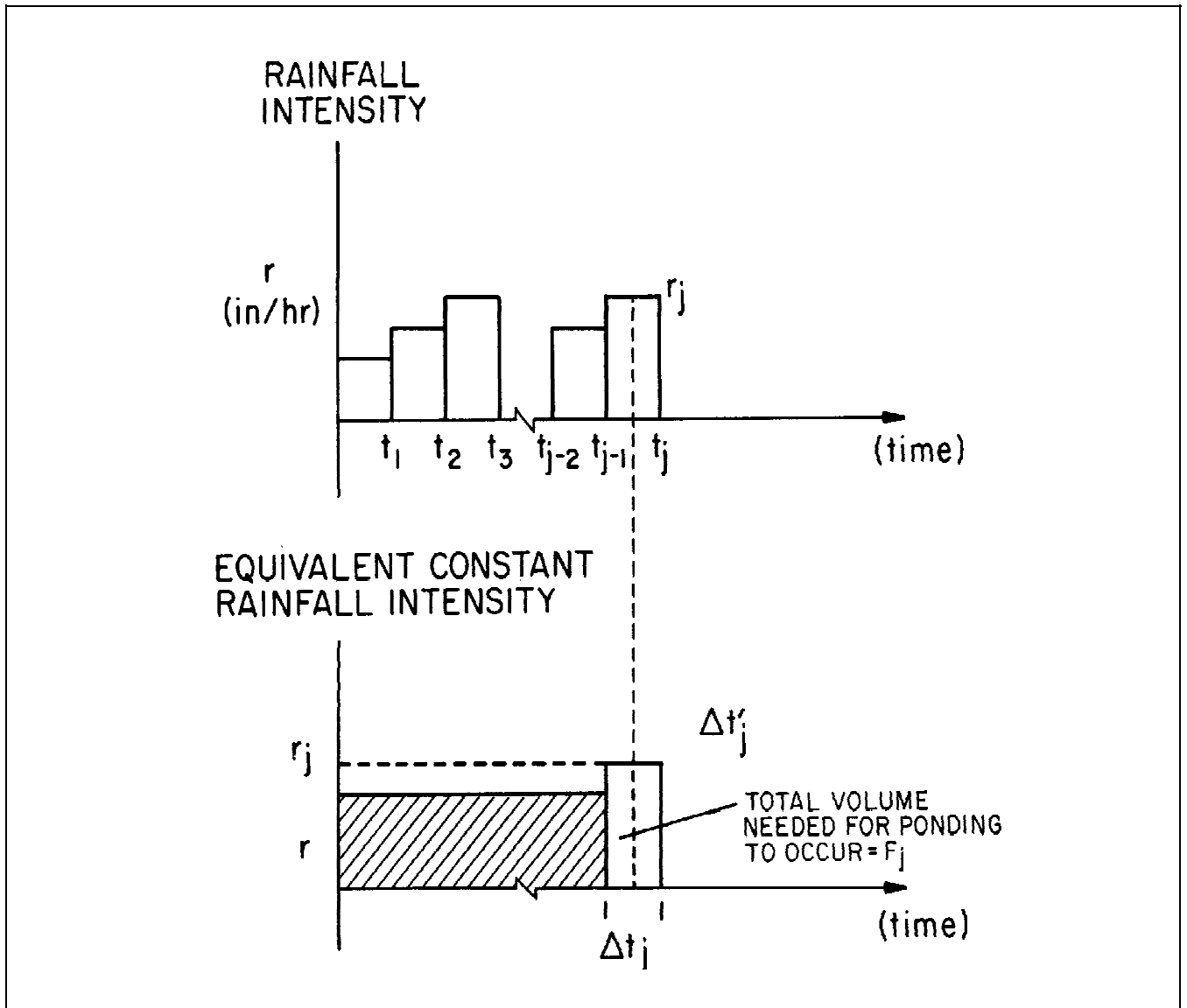

Figure 6-6. Green and Ampt application of variable rainfall rate

If the rainfall rate is less than K or if:

$$\Delta t_j^1 = \frac{\Delta I}{r_j} > \Delta t_j \quad (6-5)$$

then ponding does not occur. Otherwise, the ponding time is equal to:

$$t_p = t_{j-1} + \Delta t_j^1 \quad (6-6)$$

Once ponding has occurred, the cumulative infiltration is computed by integrating Equation 6-3 to obtain:

$$(I/S_f) - \ln(1 + (I/S_f)) = (K/S_f) (t + t_e - t_p) \quad (6-7)$$

with the initial condition that at $t = t_p$, $I = I_p$ where I_p is the cumulative infiltration at ponding and:

$$t_e = (S_f/K) ((I_p/S_f) - \ln(1 + (I_p/S_f))) \quad (6-8)$$

(b) Prior to ponding, the rainfall excess rate is zero. The rainfall excess rate after ponding is determined by subtracting the incremental infiltration from the rainfall during a period:

$$e_j = (r_j \Delta t_j - \Delta I) / \Delta t_j \quad (6-9)$$

where

e_j = excess rate during any period

ΔI = incremental infiltration, which is equal to the difference between applying Equation 6-7 for times t_j and t_{j-1}

Notice that Equation 6-7 does not give an explicit expression for I . An approximate technique described by Li, Stevens, and Simons (1976) is one approach that can be used to solve for I at any t .

(c) There may be instances when the rainfall rate during a storm drops below the infiltration rate after an initial ponding time has been calculated. In this case, a new ponding time is calculated by keeping track of the accumulated infiltration and reapplying Equation 6-4; then Equation 6-7 is applied as before to calculate the excess rate.

(d) The infiltrated volume computed by this method should always be compared with the total storage volume available in the soil profile. The storage volume in the soil profile may be computed as:

$$S_a = (\Delta \theta) d \quad (6-10)$$

where

S_a = available initial soil storage

d = depth of the soil profile

The GA method is not constrained by storage considerations because of the assumption of an infinite profile.

(2) Parameter estimation. Readily available information from soil surveys, texture class, and particle size distribution has been used to estimate the GA parameters. Texture class differentiates between types of soils (sand, sandy loam) as shown in Figure 6-7 based on ranges in particle size distribution, the percent sand, silt, and clay contained in the soil. The general procedure involved has been to relate this information to the GA parameters via the water retention characteristics of the soil. The moisture retention characteristics are defined by the relationship of water content to the soil suction (Figure 6-8). Soil suction is essentially a capillary effect, the drier and finer textured the soil (a clay is a finer textured soil than a sand), the greater the suction. Brooks and Corey (1964) suggested that the water retention versus suction relationship could be represented by:

$$S_e = (\theta - \theta_r) / (\theta_s - \theta_r) = (h_c / h_{cb})$$

where

S_e = effective saturation

TEXTURE CLASS ?

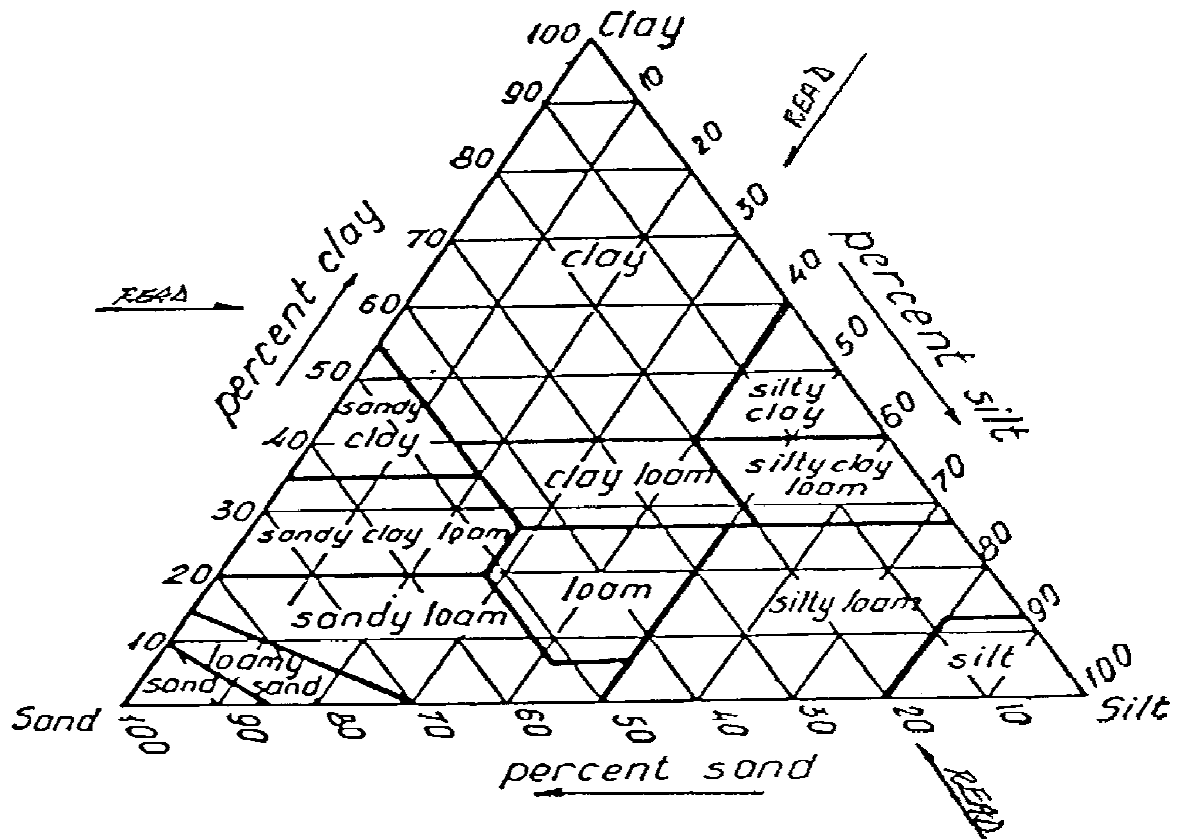

SOILS GROUPED BASED ON RANGES
OF PARTICLE SIZE DISTRIBUTION

PARTICLE SIZE DISTRIBUTION IS THE
THE SOIL'S PERCENT SAND, SILT AND CLAY

Figure 6-7. USDA texture triangle

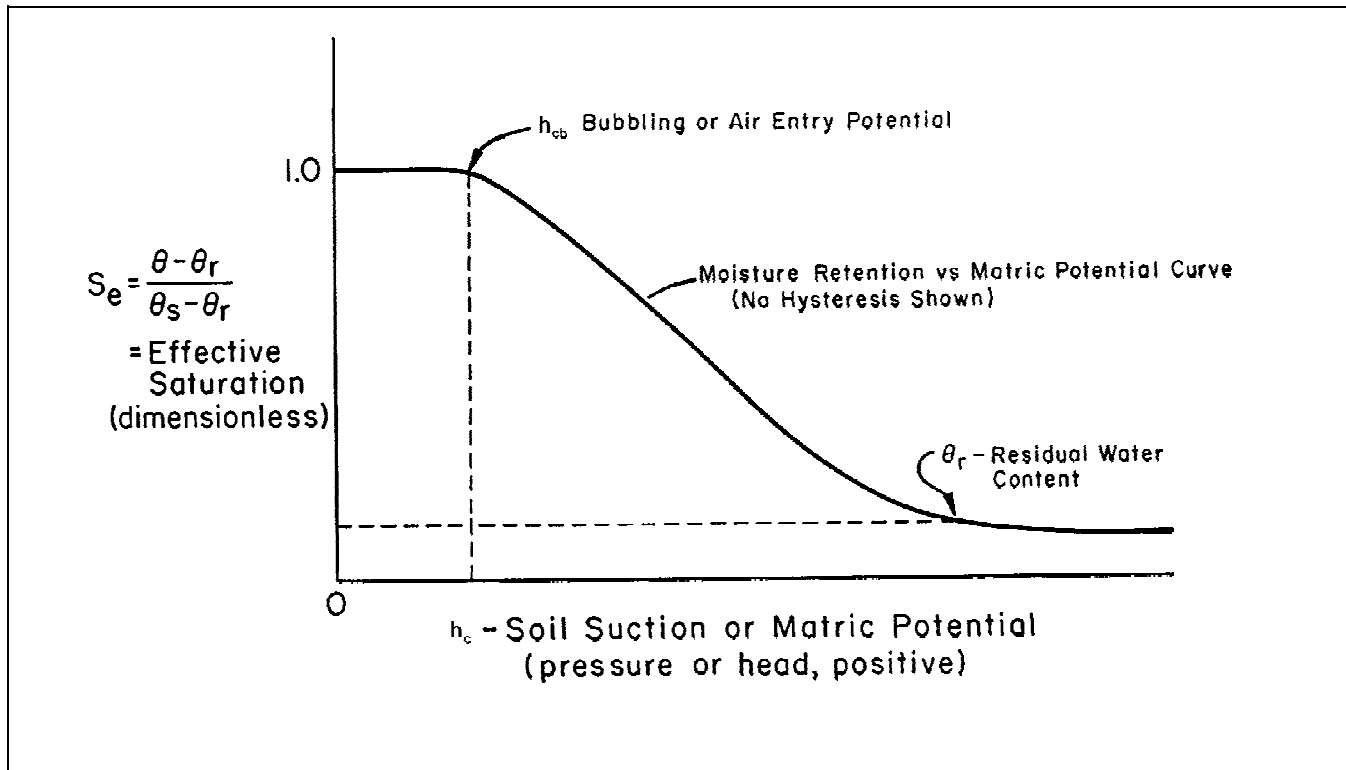

Figure 6-8. Water content versus suction

Θ = volumetric water content at suction, h_c

θ_r = residual saturation

θ_s = water content at saturation

h_{cb} = bubbling pressure

λ = pore size distribution

$$\eta = 3\lambda + 2 \quad (6-14)$$

Assuming that the initial water content is equal to the residual saturation, the formula finally derived by Brakensiek (1977) and applied by Rawls and Brakensiek (1982a) is obtained as:

$$h_f = \frac{\eta}{\eta - 1} h_{ce} \quad (6-15)$$

The Brooks and Corey parameters are then used to calculate the wetting front suction, h_f , by:

$$h_f = h_{ce} + [(\eta^{h_{ce}})/(1 - \eta)][h_{ci}^{(1-\eta)} - h_{ce}^{(1-\eta)}] \quad (6-12)$$

$$h_{ce} = h_{cb}/2 \quad (6-13)$$

where

h_{ce} = water entry pressure

h_{ci} = water content corresponding to the initial soil water content of the soil prior to ponded infiltration

Research performed by Rawls and Brakensiek (1983) and Rawls, Brakensiek, and Soni (1983) related the GA parameter total porosity and the Brooks and Corey parameters to soil texture class as shown in Table 6-2. The information shown in the table can be used together with an estimate of the initial water content via Equation 6-12 to estimate h_f . Estimates of h_f for initial water content equal to the residual saturation are shown in Table 6-2 for informational purposes.

(a) Attempts made by these researchers to find a relationship between texture class and saturated hydraulic

Table 6-2
Texture Class Estimates
(from Rawls and Brakensiek 1982 and Rawls, Brakensiek, and Saxton 1982)

Texture class	Sample size	Total porosity ¹ θ cm ³ /cm ³	Residual saturation ¹ θ_r cm ³ /cm ³	Bubbling pressure ¹ h_{cb}		Pore size distribution ¹ λ		Saturated hydraulic conductivity K_s cm/h	λ	h_f cm
				Arithmetic cm	Geometric ² cm	Arithmetic	Geometric			
Sand	762	0.437* (0.374-0.500)	0.020 (0.001-0.039)	15.98 (0.24-31.72)	7.26 (1.36-38.74)	0.694 (0.298-1.09)	0.592 (0.334-1.05)	21.00	0.694	10.6
Loamy sand	338	0.437 (0.368-0.506)	0.035 (0.003-0.067)	20.58 (0.0-45.20)	8.69 (1.80-41.85)	0.553 (0.234-0.872)	0.474 (0.271-0.827)	6.11	0.553	14.2
Sandy loam	666	0.453 (0.351-0.555)	0.041 (0.0-0.106)	30.20 (0.0-64.01)	14.66 (3.45-62.24)	0.378 (0.140-0.616)	0.322 (0.186-0.558)	2.59	0.378	22.2
Loam	383	0.463 (0.375-0.551)	0.027 (0.0-0.074)	40.12 (0.0-100.3)	11.15 (1.63-76.40)	0.252 (0.086-0.418)	0.220 (0.137-0.355)	1.32	0.252	31.5
Silt loam	1206	0.501 (0.420-0.582)	0.015 (0.0-0.058)	50.87 (0.0-109.4)	20.76 (3.58-120.4)	0.234 (0.105-0.363)	0.211 (0.136-0.326)	0.68	0.234	40.4
Sandy clay loam	498	0.398 (0.332-0.464)	0.068 (0.0-0.137)	59.41 (0.0-123.4)	28.08 (5.57-141.5)	0.319 (0.079-0.559)	0.250 (0.125-0.502)	0.43	0.319	44.9
Clay loam	366	0.464 (0.409-0.519)	0.075 (0.0-0.174)	56.43 (0.0-124.3)	25.89 (5.80-115.7)	0.242 (0.070-0.414)	0.194 (0.100-0.377)	0.23	0.242	44.6
Silty clay loam	689	0.471 (0.418-0.524)	0.040 (0.0-0.118)	70.33 (0.0-143.9)	32.56 (6.68-158.7)	0.177 (0.039-0.315)	0.151 (0.090-0.253)	0.15	0.177	58.1
Sandy clay	45	0.430 (0.370-0.490)	0.109 (0.0-0.205)	79.48 (0.0-179.1)	29.17 (4.96-171.6)	0.223 (0.048-0.398)	0.168 (0.078-0.364)	0.12	0.223	63.6
Silty clay	127	0.479 (0.425-0.533)	0.056 (0.0-0.136)	76.54 (0.0-159.6)	34.19 (7.04-166.2)	0.150 (0.040-0.260)	0.127 (0.074-0.219)	0.09	0.150	64.7
Clay	291	0.475 (0.427-0.523)	0.090 (0.0-0.195)	85.60 (0.0-176.1)	37.30 (7.43-187.2)	0.165 (0.037-0.293)	0.131 (0.068-0.253)	0.06	0.165	71.4

NOTE: The wetting front suction, h_f , value shown, assume dry initial moisture conditions.

¹ First line is the mean value, second line is + one standard deviation about the mean

² Antilog of the log mean

conductivity, K , were unsuccessful because the variance of K within the texture class is too large. However, Rawls and Brakensiek (1983) and Rawls, Brakensiek, and Soni (1983) did provide average estimates of K for the soils sampled in their survey as shown in Table 6-2. Note that variances about the mean value for each of the parameters are shown in this table except for K because texture class was not found to be a discriminator of this variable.

(b) Additional work has been performed by Ahuja et al. (1988) and Rawls and Brakensiek (1989) to improve predictions of GA parameters using particle size

distribution and/or soil porosity. Further modifications to the estimates for surface cover characteristics, stones, and surface crusts have been developed by Rawls and Brakensiek (1983); Rawls, Brakensiek, and Soni (1983); and Rawls, Brakensiek, and Savabi (1988).

(c) An initial water content θ_i must be selected prior to determining $\Delta\theta$ and h_f . A means for estimating θ_i may be to relate watershed moisture conditions to an antecedent precipitation index.

b. Holtan loss rate method. The Holtan loss rate method is expuned and illustrated in detail below.

(1) Method development. Holtan et al. (1975) used a conceptual soil storage element to compute infiltration rates based on the formula:

$$i = (GI) A S_a^\beta + f_c \quad (6-16)$$

where

i = potential infiltration rate in inches per hour

GI = "growth index" representing the relative maturity of the ground cover

A = inches per hour per inch of available storage and is an empirical factor discussed in more detail in the next section

S_a = soil storage capacity in inches of equivalent depth of pore space in the surface layer of the soil, f_c is the constant rate of percolation of water through the soil profile below the surface layer

β = empirical exponent, typically taken equal to 1.4

The available storage, S_a , is decreased by the amount of infiltrated water and *increased at the percolation rate*, f_c . Note that by calculating S_a in this manner, soil moisture recovery occurs at the deep percolation rate. The method is applied to a variable rainfall rate by continuously accounting for storage using the following relationship, given the initial soil deficit S_{a0} :

$$S_{a_i} = S_{a_{i-1}} - i\Delta t + f_c\Delta t \quad (6-17)$$

where

$S_{a_i}, S_{a_{i-1}}$ = storage deficit at the beginning and ending of period Δt

i = average infiltration rate during this period

$(f_c\Delta t)$ = drainage volume out of storage

The volume draining from storage is limited by the maximum allowable deficit S_a . The average infiltration over the period is the minimum of the available rainfall or the potential infiltration rate. The potential infiltration rate is calculated as:

$$i = \frac{(i_i + i_{i-1})}{\Delta t} \quad (6-18)$$

where

$$i_{i-1} = (GI)AS_{a_{i-1}}^\beta + f_c \quad (6-19)$$

$$i_i = (GI)AS_{a_i}^\beta + f_c \quad (6-20)$$

The potential infiltration rate (essentially the average infiltration rate) must be calculated implicitly or iteratively since it is a function of the storage deficit at the end of the period. The excess rate is the difference between the rainfall rate and average infiltration rate.

(2) Parameter estimation. The factor "A" is interpreted as an index of the pore volume which is directly connected to the soil surface. The number of surface-connected pores is related to the root structure of the vegetation, so the factor "A" is related to the cover crop as well as the soil texture. Since the surface-connected porosity is related to root structure, the growth index (GI) is used to indicate the development of the root system. In agricultural basins, GI will vary from near zero when the crop is planted to 1.0 when the crop is full-grown.

(a) Holtan et al. (1975) have made estimates of the value of "A" for several vegetation types. Their estimates were evaluated as the percent of the ground surface occupied by plant stems or root crowns at plant maturity. Skaggs and Kahleel (1982) provide estimates as shown in Table 6-3.

(b) Estimates of f_c can be based on either the values given in Table 6-3 (Skaggs and Kahleel 1982) or the hydrologic soil group given in the SCS Handbook (1972). Musgrave (1955) has given the following values of f_c in inches per hour for the four hydrologic soil groups: A, 0.45 to 0.30; B, 0.30 to 0.15; C, 0.15 to 0.05; D, 0.05 or less.

(c) The total soil storage capacity can be computed using information in Table 6-2 as:

$$S_a = (\phi - \theta_r)d \quad (6-21)$$

Table 6-3
Holtan Parameters

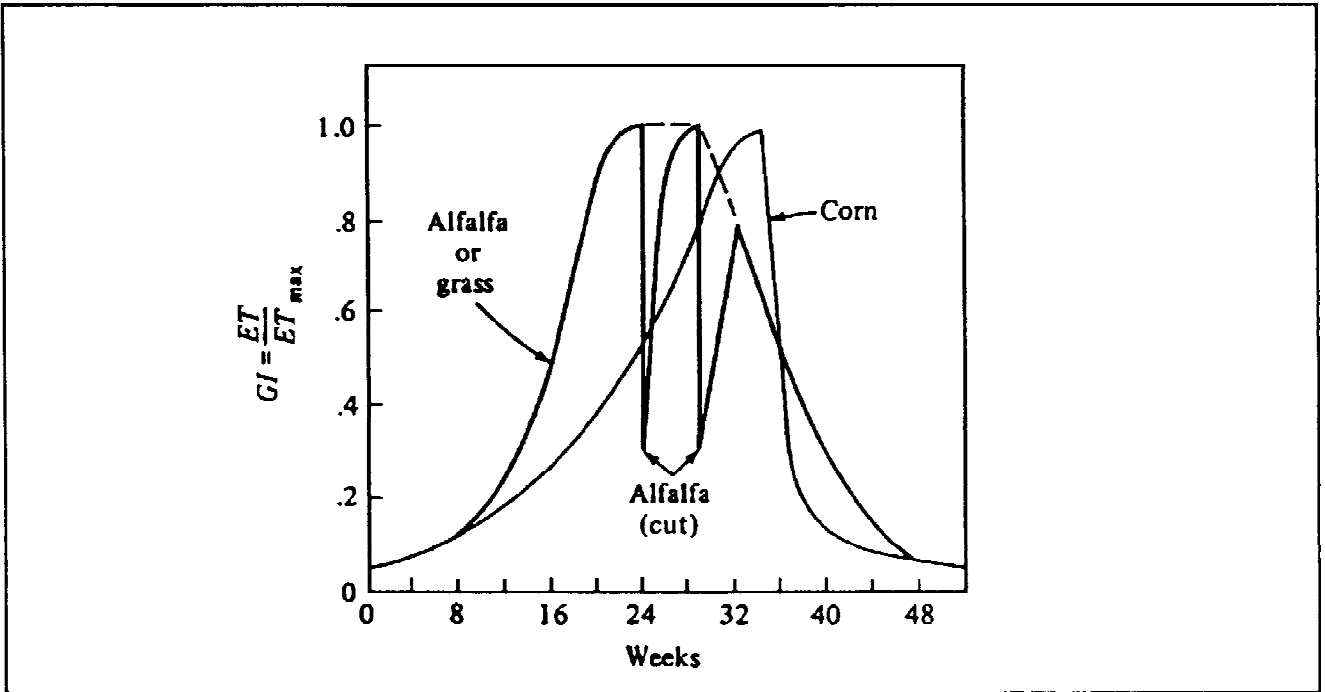

Growth index $GI = ET/ET_{max}$ from lysimeter records, irrigated corn, and hay for 1955, Coshocton, Ohio.

Estimates of Holtan A

Land use or cover	Basal Area Rating ¹	
	Poor Condition	Good Condition
Fallow ²	0.10	0.30
Row crops	0.10	0.20
Small grains	0.20	0.30
Hay (legumes)	0.20	0.40
Hay (sod)	0.40	0.60
Pasture (bunchgrass)	0.20	0.40
Temporary pasture (sod)	0.40	0.60
Permanent pasture (sod)	0.80	1.00
Woods and forests	0.80	1.00

¹ Adjustments needed for "weeds" and "grazing."
² For fallow land only, "poor condition" means "after row crop," and "good condition" means "after sod."

Source: Holtan et al. (1975)

where d = depth of the soil horizon. The initial deficit is given by Equation 6-10. The initial water content would have to be determined from an assessment of past conditions.

c. *Soil Conservation Service curve number method.* The SCS curve number method is explained in detail below.

(1) Method development. The curve number (CN) method depends on the following basic relationship:

$$\frac{F}{S} \text{ and } \frac{Q}{P} \rightarrow 1 \text{ as } P \rightarrow \infty \quad (6-22)$$

where

F = watershed retention of water

S = maximum available retention capacity

Q = direct runoff

P = total storm precipitation (in consistent units of volume; for example, basin-inches)

The retention parameter, S , is related to the CN by a relationship that will be discussed in the next section on parameter estimation. The supposition that $F = S$ as the amount of precipitation becomes large seems reasonable, since most of the precipitation will directly runoff as the watershed soils become saturated. $Q = P$ is a fair approximation for the same reason.

(a) A parametric relationship for calculating direct runoff can be developed by setting $F = (P - Q - I_a)$ and then solving for Q , assuming that Equation 6-22 applies:

$$\frac{F}{S} = \frac{(P - Q - I_a)}{S} = \frac{Q}{P} \quad (6-23)$$

where I_a = basin volume is equal to the initial abstraction of rainfall (i.e., the observed rainfall depth prior to the observation of runoff). Solving Equation 6-23 for Q gives the desired direct runoff:

$$Q = \frac{(P - I_a)^2}{(P - I_a + S)} \quad (6-24)$$

in terms of the precipitation and the parameters of the methods I_a and S .

(b) The CN method does not incorporate time explicitly into the formulation. Consequently, the application of the method to a rainfall hyetograph requires that time be incorporated rather simply into Equation 6-24 as:

$$Q(t) = \frac{(P(t) - I_a)^2}{(P(t) - I_a + S)} \quad (6-25)$$

where

$Q(t)$ = cumulative runoff at time t

$P(t)$ = cumulative rainfall minus I_a at time t

The incremental runoff depth over a period $\Delta t = t_2 - t_1$:

$$\Delta Q = Q(t_2) - Q(t_1) \quad (6-26)$$

Note, the computation of cumulative excess by Equation 6-25 is entirely dependent on the cumulative precipitation at any time. The total infiltration, therefore (like the runoff) is independent of the storm pattern.

(2) Parameter estimation. The parameters of the CN method were estimated by examining a great deal of data from small (less than 10 acres) agricultural watersheds in the midwestern United States. The goal was to relate I_a and S to physical characteristics of the watershed. To simplify this problem, Equation 6-24 is transformed to use only a single parameter by developing the following relationship from test watershed data:

$$I_a = 0.2S \quad (6-27)$$

A further simplification was made by relating S to CN as:

$$CN = \frac{1000}{S + 10} \quad (6-28)$$

This transformation was performed according to Victor Mockus (1964) so that the rainfall-runoff curves from Equation 6-26 would plot at nearly equal intervals across a graph sheet. The CN was assumed to be related to the soil and cover conditions of a watershed. A search was made by Mockus for test watersheds with a single cover

characteristic and soil type. Total rainfall versus runoff volumes were analyzed graphically to determine the appropriate CN for the soil type and cover for each watershed. As might be expected, there was a great deal of scatter in the observed data when plotted in this manner. The CN that resulted in a curve that divided the plotted data in half was deemed appropriate.

(a) A relationship between CN and watershed potential runoff was developed by determining enveloping CN for the scattered data. This results in three sets of curves that divide and bound test data for an individual watershed. In the past (SCS 1972), the upper and lower enveloping curves were assumed to be related to relatively wet (AMC III) and dry (AMC I) watershed soil moisture conditions and the dividing curve by average soil moisture conditions (AMC II). The CN associated with these different soil moisture conditions was then related to the 5-day antecedent rainfall. However, the relationship between antecedent rainfall and AMC has been poor and the SCS no longer relates the potential runoff to an AMC. Rather, the potential runoff defined by the curves enveloping the scattered data is now related to three antecedent runoff conditions, ARC(III) for relatively high runoff potential, ARC(I) for relatively low runoff potential, and ARC(II) for average runoff potential.

(b) The average CN value for a particular watershed and the effect of ARC on CN should be determined based on observed rainfall versus runoff. The SCS now recommends that the calibration method used by Mockus or a statistical analysis of rainfall versus runoff data be used to determine the CN for each ARC value. Table 64 displays the effect of ARC condition on curve number based on the past work by Mockus in developing envelope curves of CN for observed rainfall versus runoff. McCuen (1989, pg. 299) cautions that this table is only applicable for the region where the CN was calibrated and should be adjusted based on regional information. His recommended caution refers to the use of the now obsolete AMC designations but is equally relevant to the ARC designations in the table. If data are not available for making adjustments to the curve number, then the ARC(II) curve numbers of Table 64 should be used.

(c) The CN corresponding to a large number of soil types and cover characteristics are reported by the SCS. Consequently, application of the method requires that soil survey information be available for the watershed of interest. A soil survey provides the information needed to choose CN based on soil type, cover, management practice, and hydrologic condition. Hydrologic group indicates in-situ infiltration capacity by classifying the soils as

type A, B, C, or D, with A having the highest and D the lowest capacities. The CN associated with each group (Table 6-5) is determined based on the cover (agricultural versus forest), management practice (tillage practice and mulching), and hydrologic condition (degree of grazing or percentage of area with good cover characteristics). A more detailed table of curve numbers can be found in SCS TR-55 (SCS 1986) or the National Engineering Handbook, Chapter 4 (SCS 1972).

(d) Although the CN method is easily the most popular method for performing ungauged analysis, there has been extensive criticism of the method because it does not lead to accurate reproduction of runoff hydrographs, the predicted infiltration rates are not in accordance with classical unsaturated flow theory, the method is applied to watersheds for which it was not calibrated, and the original calibration results are not available. As pointed out by Rallison and Miller (1981), p 361:

The CN procedure continues to be most satisfactory when used for the type of hydrologic problem that it was developed to solve--evaluating effects of land use changes and conservation practices on direct runoff. Since it was not developed to reproduce individual historical events, only limited success has been achieved by those using it for that purpose.

Despite this well recognized deficiency, the method remains popular for simulating rainfall hydrographs.

(e) The method has received criticism because it is at variance with the results of classical unsaturated flow theory, as can be seen by examining the infiltration rate implied by Equation 6-25 (Smith 1976, Aron, Miller, and Lakatos 1977, and Morel-Seytoux and Verdin 1981):

$$i = \frac{S^2 r}{(P - I_a + S)^2} \quad (6-29)$$

where

i = infiltration rate

r = rainfall intensity

Morel-Seytoux (1981) points out that i and P are inversely related. As one would expect, the proportionality of i and r is "in direct disagreement with field experience, laboratory evidence and physical theory," which

Table 6-4
Antecedent Runoff Condition Adjustments

CN Adjustment for Wetness		
ARCII	ARCI	ARCIII
100	100	100
95	87	98
90	78	96
85	70	94
80	63	91
75	57	88
70	51	85
65	45	82
60	40	78
55	35	74
50	31	70
45	26	65
40	22	60
35	18	55
30	15	50
25	12	43
20	9	37
15	6	30
10	4	22
5	2	13

shows that i is independent of r for a ponded surface condition.

(f) Perhaps the most disturbing aspect of the CN method is that the original calibration results obtained by Victor Mockus (1964) have not been preserved. Consequently, the only means of evaluating the observed performance of the method is to examine current results from the literature or from personal experience.

(g) However, despite the missing calibration results, it is clear that the method is being used for watersheds where data did not exist to calibrate the method. Rallison and Miller (1981) p 361 point out:

Data for developing reliable curve numbers are not equally available throughout the United States. Information on rainfall, runoff and soil is deficient for many range and forest areas, particularly in the Western States and, as a consequence, there are many soil complexes that are either unclassified or lack data for verification. The sparseness of rainfall-runoff data in urban or urbanizing areas has forced reliance on interpretive values with little "hard" data available for verification....

Despite these caveats about the CN method, engineers continue to use the method because it has been the only

Table 6-5
Runoff CN's for Hydrologic Soil-Cover Complexes
(Antecedent runoff condition II, and $I_a = 0.2S$)

Land use	Cover		Hydrologic Soil Group			
	Treatment or practice	Hydrologic Condition	A	B	C	D
Fallow	Straight row		77	86	91	94
Row crops	Straight row	Poor	72	81	88	91
		Good	67	78	85	89
	Contoured	Poor	70	79	84	88
		Good	65	75	82	86
Contoured and terraced	Poor	66	74	80	82	
	Good	62	71	78	81	
Small grain	Straight row	Poor	65	76	84	88
		Good	63	75	83	87
	Contoured	Poor	63	74	82	85
		Good	61	73	81	84
Contoured and terraced	Poor	61	72	79	82	
	Good	59	70	78	81	
Close-seeded legumes ¹ or rotation meadow	Straight row	Poor	66	77	85	89
		Good	58	72	81	85
	Contoured	Poor	64	75	83	85
		Good	55	69	78	83
Contoured and terraced	Poor	63	73	80	83	
	Good	51	67	76	80	
Pasture or range	Contoured	Poor	68	79	86	89
		Fair	49	69	79	84
		Good	39	61	74	80
		Poor	47	67	81	88
		Fair	25	59	75	83
		Good	6	35	70	79
Meadow		Good	30	58	71	78
Woods		Poor	45	66	77	83
		Fair	36	60	73	79
		Good	25	55	70	77
Farmsteads			59	74	82	86
Roads (dirts) ² (hard surface) ²			72	82	87	89
			74	84	90	92

¹ Closed-drilled or broadcast.

² Including right-of-way.

Note: For a more detailed table of CN's, see SCS (1986) or SCS (1972).

one available that relates readily available watershed characteristics to a loss rate method.

(h) Caution should be used in applications to areas where the CN method has not been calibrated. Information on regional rainfall-runoff characteristics should be

obtained, if possible, to judge whether or not the CN method predictions are useful.

(i) Rallison and Miller's comments with regard to applications in urban areas are particularly noteworthy. The CN usually chosen for open land uses in urban areas

are generally based on CN values determined for pasture land use. However, runoff tends to be greater from the open urban areas than that from a pasture land use. A common approach for adjusting for this affect is to reduce the value of I_a , thus relaxing the constraint that $I_a = 0.2S$. This approach is not appropriate since the relationship between the initial abstraction and watershed retention is critical to the reported CN calibration (1986). Either attempts should be made to find regional or local information for recalibrating CN, or the CN should be adjusted based on some judgment for open land use in urban areas.

(j) Researchers have suggested means for utilizing the empirical data present in the curve number method in more physically based infiltration equations. Hjelmfelt (1980) suggested a procedure for incorporating CN information into the Holtan equation. Morel-Seytoux and Verdin (1981) suggested a procedure for doing the same with the Green and Ampt equation. However, one might wonder about the efficacy of this approach since there is no information available which details the accuracy of the original CN calibration to observed data or whether or not it is useful for rainfall-runoff simulations.

d. Initial and constant loss rate method. The initial and constant loss rate method is described in detail below.

(1) Method development. This is a very simple method and does not need much explanation. An initial loss (units of depth) and a constant loss rate (units of depth/hour) are specified for this method. All rainfall is lost until the volume of initial loss is satisfied. After the initial loss is satisfied, rainfall is lost at the constant rate. As in the case of the GA method, infiltrated volumes computed by the initial and constant loss rate method are not constrained by the storage capacity of the soil profile. Consequently, a comparison should be made of the infiltrated volume and soil storage capacity to be sure that the parameters chosen for the method are appropriate.

(2) Parameter estimation. The initial and constant loss rate method, having only two parameters, is valuable in the application of automatic parameter estimation procedures. However, the method could also be used in ungauged analysis by assuming a physical interpretation of the parameters. The constant loss might be interpreted as the ultimate infiltration capacity of the soils. The initial loss might reflect both antecedent moisture conditions and losses prior to reaching the ultimate infiltration capacity.

6-6. Impervious Areas

a. Estimation of losses from an urban area is complicated by the presence of impervious surfaces which are not hydraulically connected to drainage systems. Typically, these areas are roof tops with downspouts that drain to flower beds or lawns. The critical part of the analysis is to determine if the pervious area can infiltrate the flow received from the unconnected impervious area. A method applied by SCS (1986) considered this problem in determining corrections for the curve number based on the percent of total and unconnected impervious areas as shown in Figure 6-9. The corrections are only applicable for areas with up to 30 percent total impervious area. If the percent impervious area exceeded this amount, then the assumption was that the unconnected impervious area runoff would not infiltrate because of the small retention time on pervious areas.

b. Figure 6-9 was established by calculating the amount of runoff from the unconnected impervious watershed area due to a given rainfall depth and *uniformly* distributing this volume over the pervious area (McCuen 1989). The runoff from the pervious area was then calculated based on the pervious area curve number and the combined volume from rainfall and unconnected impervious area runoff. The apparent curve number for the entire watershed is then back calculated from knowing the total rainfall and the combined runoff from the pervious area and connected impervious area. This procedure could be duplicated for methods other than the curve number.

c. Caution should be used when applying Figure 6-9 because of the assumptions used in its development. In many instances, conveyance of flow from unconnected impervious areas may not exist or may be very direct. For example, portions of a rooftop may directly drain to a backyard which does not drain easily into the street gutter. However, the drainage path from the downspouts draining the front portion of the rooftop may be rather short, providing little opportunity for infiltration. Certainly, local knowledge of drainage design is needed to judge to what degree unconnected impervious area acts as if it were hydraulically connected.

d. Caution should also be used when composite impervious/pervious values for loss rate parameters are provided for a particular land use. For example, SCS (1986) provides Table 6-6 for applications in urban hydrology. Notice that in this table composite curve number are given for urban land uses as a function of

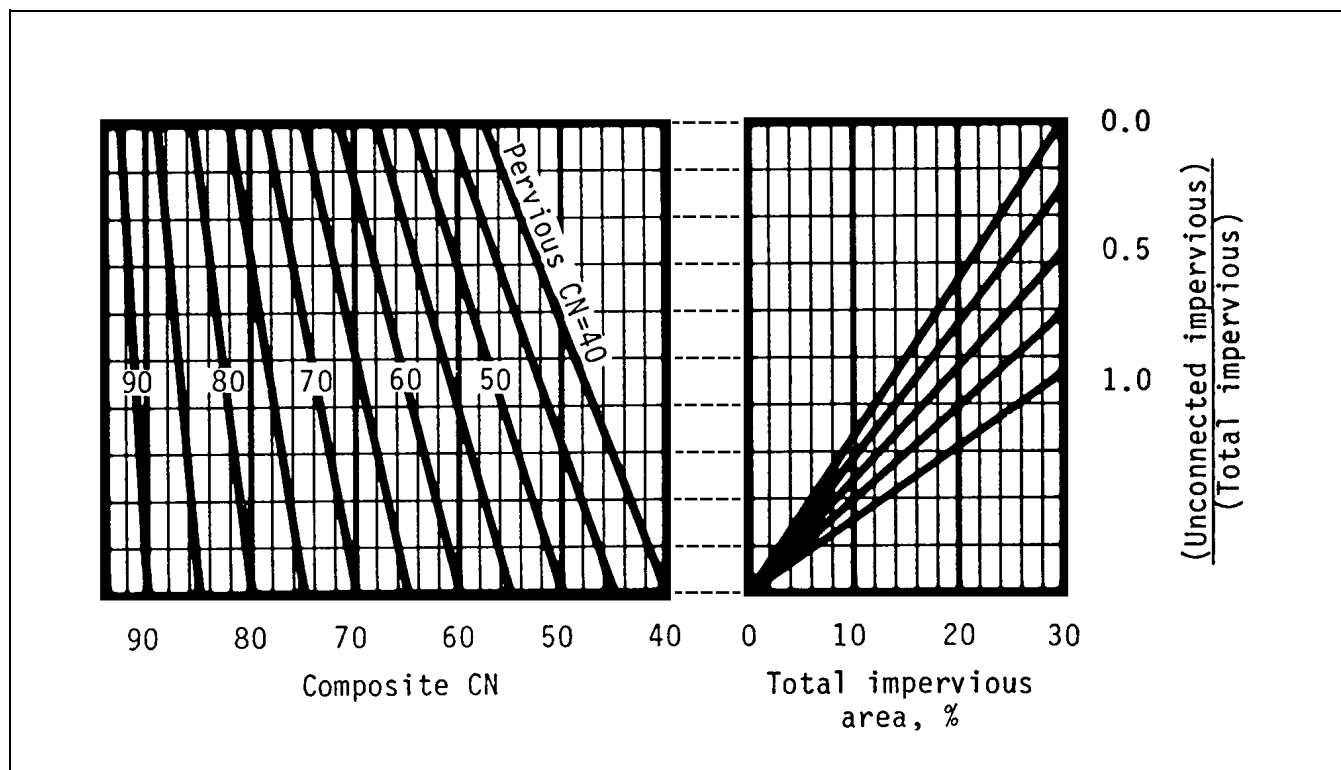

Figure 6-9. Correction for unconnected impervious area (SCS 1986)

zoning and hydrologic soil group. The assumption made in deriving these values is that the impervious areas have a CN of 98, and the open areas correspond to pastures in good condition. Weighting these values with percent impervious area CN's when computing the CN for a particular watershed area would lead to double accounting of the impervious area.

6-7. Method Seloolon

a. The selection of the loss rate method is a function of the data availability, land use, and the purpose of the loss rate calculation. If a reasonably long gauge record is available, then any of the methods discussed will be adequate when determining parameter estimates with automatic calibration techniques. A possible exception is the CN method. The loss rate function implied by the method is very unappealing and should relegate the method to a last resort application when using an automatic calibration technique. However, if the record is inadequate due to record length or data errors, then method selection depends on the preferred parameter estimation approach for ungauged analysis.

b. The ungauged analysis parameter estimation approaches are used alternatively: utilize texture class or particle size distribution in the Green and Ampt method, utilize USDA classifications for the Holtan method, determine the CN from soil hydrologic group and cover classification, and calibrate any method, the initial and constant loss rate method being simplest, to a regional frequency curve. Each method has its benefits depending on the purpose of the calculation and the experience that has been gained with the method.

c. A caution at this point concerning the application of the Green and Ampt and Holtan methods to forested areas is warranted. These methods assume an overland flow-type mechanism which is not entirely appropriate for forested areas where a subsurface mechanism tends to control direct runoff. Applications to forested areas probably should rely on empirical methods calibrated to regional information such as regional frequency curves or correlation between observed rainfall-runoff characteristics and watershed characteristics as is done by the CN method.

Table 6-6
Runoff CN's for Selected Agricultural, Suburban, and Urban Land Use

Land Use Description	Hydrologic Soil Group			
	A	B	C	D
Cultivated land ¹ :				
without conservation treatment	72	81	88	91
with conservation treatment	62	71	78	81
Feature or range land:				
poor condition	68	79	86	89
good condition	39	61	74	80
Meadow: good condition	30	58	71	78
Wood or forest land:				
thin stand, poor cover, no mulch	45	66	77	83
good cover ²	25	55	70	77
Open Spaces, lawns, parks, golf courses, cemeteries, etc.				
good conditions: grass cover on 75% or more of the area	39	61	74	80
fair conditions: grass cover on 50% to 75% of the area	49	69	79	84
Commercial and business areas (85% impervious)	89	92	94	95
Industrial districts (72% impervious)	81	88	91	93
Residential: ³				
Average lot size				
Average % Impervious ⁴				
1/8 acre or less	65			
1/4 acre	38			
1/3 acre	30			
1/2 acre	25			
1 acre	20			
Paved Parking lots, roofs, driveways, etc. ⁵	98	98	98	98
Streets and roads:				
paved with curbs and storm sewers ⁵	98	98	98	98
gravel	76	85	89	91
dirt	72	82	87	89

¹ For a more detailed description of agricultural land use CN's, refer to SCS (1972).

² Good cover is protected from grazing, littering, and brush cover soil.

³ CN's are computed assuming the runoff from the house and driveway is directed toward the street with a minimum of roof water directed to lawns where additional infiltration could occur.

⁴ The remaining pervious areas (lawn) are considered to be in good pasture condition for these CN's.

⁵ In some warmer climates of the country, a CN of 95 may be used.

Chapter 7 Precipitation Excess - Runoff Transformation

7-1. General

The transformation of precipitation excess to runoff is a key factor in flood-runoff analysis. Two approaches are described. The first employs the unit hydrograph and is based on the assumption that a watershed, in converting precipitation excess to runoff, acts as a linear, time-invariant system. The second approach is based on mathematical simulation of surface runoff using the kinematic wave approximation of the unsteady flow equations for one-dimensional open channel flow. In this chapter, the basis for the approaches, data requirements, calibration procedures, and limitations are described.

7-2. Runoff Subdivision

The methods in this chapter treat total runoff (i.e., streamflow) as being composed of two components, direct runoff and base flow. *Direct runoff* results from *precipitation excess*, which is regarded herein as that portion of storm precipitation that appears as streamflow during or shortly after a storm. *Base flow* results from subsurface runoff from prior precipitation events and delayed subsurface runoff from the current storm. The difference between total storm precipitation and precipitation excess is termed *losses* (or abstractions). This chapter deals with the calculation of direct runoff, given precipitation excess. Methods for estimating losses are described in Chapter 6. Base flow must be added to direct runoff to obtain total runoff. Base flow estimation is treated in Chapter 8. Precipitation includes both rain and snow. The methods described in this chapter are generally applied to rainfall excess. However, some applications involve the combining of rainfall excess with snowmelt excess as the basis for direct runoff determination. Chapter 5 deals with snowmelt estimation.

7-3. Unit Hydrograph Approach

a. Concepts.

(1) The unit hydrograph represents direct runoff at the outlet of a basin resulting from one unit (e.g., 1 in.) of precipitation excess over the basin. The excess occurs at a constant intensity over a specified duration. Assumptions associated with application of a unit hydrograph are the following:

(a) Precipitation excess and losses can be treated as basin-average (lumped) quantities.

(b) The ordinates of a direct runoff hydrograph corresponding to precipitation excess of a given duration are directly proportional to the volume of excess (assumption of linearity).

(c) The direct runoff hydrograph resulting from a given increment of precipitation excess is independent of the time of occurrence of the excess (assumption of time invariance).

(2) Difficulties associated with the first assumption can be alleviated by dividing a basin into subbasins so that the use of lumped quantities is reasonable. Because runoff response characteristics of watersheds are not strictly linear, the unit hydrograph used with a particular storm hyetograph should be appropriate for a storm of that magnitude. Hence, unit hydrographs to be used with large hypothetical storms should, if possible, be derived from data for large historical events. In some cases, it is appropriate to adjust a unit hydrograph to account for anticipated shorter travel times for large events. The duration of precipitation excess associated with a unit hydrograph should be selected to provide adequate definition of the direct runoff hydrograph. Generally, a duration equal to about one-fifth to one-third of the time-to-peak of the unit hydrograph is appropriate.

b. Unit hydrograph application and derivation. Application of a unit hydrograph may be performed with the following equation:

$$Q(t) = \sum_{i=1}^n u[\Delta t_o, t - (i - 1)] I_i \Delta t \quad (7-1)$$

where

$Q(t)$ = ordinate of direct runoff hydrograph at time t

$u(\Delta t_o, t)$ = ordinate at time t of unit hydrograph of duration Δt_o

I_i = intensity of precipitation excess during block i of storm

n = total number of blocks of precipitation excess

Such application is represented graphically in Figure 7-1. The individual direct runoff responses to each block of precipitation excess are superimposed to produce the total direct runoff.

(1) The development of a unit hydrograph for a basin proceeds differently depending on whether a basin is gauged or ungauged. Gauged, in this case, means that there is a stream gauge at the basin outlet for which measurements during historical storms are available, and data from precipitation gauges are available with which hydrographs of basin-average precipitation can be developed for the storms. Unit hydrographs can be developed and verified with such data, as discussed later in this chapter.

(2) For ungauged basins, direct development of a unit hydrograph is not possible and techniques for estimating a unit hydrograph from measurable basin characteristics are employed. Generally, a unit hydrograph is represented mathematically as a function of one or two parameters, and these parameters are related to basin characteristics by regression analysis or other means. Several methods for representing unit hydrographs are described in the next section. Chapter 16, "Ungauged Basin Analysis," discusses the use of regional analysis for estimating unit hydrograph parameters for ungauged basins.

c. *Synthetic unit hydrographs.* Many methods have been devised for representing a unit hydrograph as a function of one or two parameters. The methods can be categorized as those that are strictly empirical and those that are based on a conceptual representation of basin runoff. The five methods described subsequently are the Single-linear Reservoir, Nash, Clark, Snyder, and SCS. The first three employ conceptual models of runoff; the latter two are empirical.

(1) Single-linear reservoir method. Conceptual models commonly employ one or more linear reservoirs as elements. A *linear reservoir* is a reservoir for which there is a linear relationship between storage and outflow:

$$S = KO \quad (7-2)$$

where

S = volume of water in storage in the reservoir

K = storage coefficient

O = rate of outflow from the reservoir

K has units of time and is constant for a linear system.

(a) A very simple conceptual model would represent the direct runoff from a basin with a single-linear reservoir (SLR). If such a reservoir is filled instantaneously with one unit of volume (i.e., representing one unit of depth over the basin area) and the reservoir is permitted to drain, it can be shown that the equation for the outflow is:

$$O(t) = \frac{1}{K} e^{-\frac{t}{K}} \quad (7-3)$$

Figure 7-2 illustrates a single-linear reservoir and the outflow hydrograph.

(b) The above equation represents an instantaneous unit hydrograph (IUH) for the basin because the duration (Δt_0) of precipitation excess is zero. The IUH can be converted to a unit hydrograph of finite duration by superposing several IUH's initiated at equal subintervals of an interval equal to the duration Δt_0 and dividing the aggregate direct runoff by the number of IUH's. If Δt_0 is sufficiently small (as is normally the case to provide adequate definition to a direct runoff hydrograph), the finite-duration unit hydrograph can be developed by simply averaging the ordinates of two IUH's that are separated in time by Δt_0 .

(c) A unit hydrograph developed with the SLR model involves a single parameter, K . That is, once a value for K is specified, the unit hydrograph can be determined. This simple model is useful for small basins with short response times.

(2) Nash model. The Nash conceptual model (Nash 1957) represents the direct runoff response of a basin by passing a unit volume of water through a series of identical linear reservoirs, as depicted in Figure 7-3. As with the SLR, the unit volume enters the upstream-most reservoir instantaneously. The outflow from the downstream-most reservoir is the IUH for the basin. The equation for the IUH is:

$$O(t) = \frac{1}{K(n-1)!} \left(\frac{t}{K}\right)^{n-1} e^{-\frac{t}{K}} \quad (7-4)$$

A unit hydrograph based on the Nash model has two parameters: the number of reservoirs, n , and the storage coefficient, K , which are identical for each reservoir. The model is widely used both for unit hydrograph development and for streamflow routing.

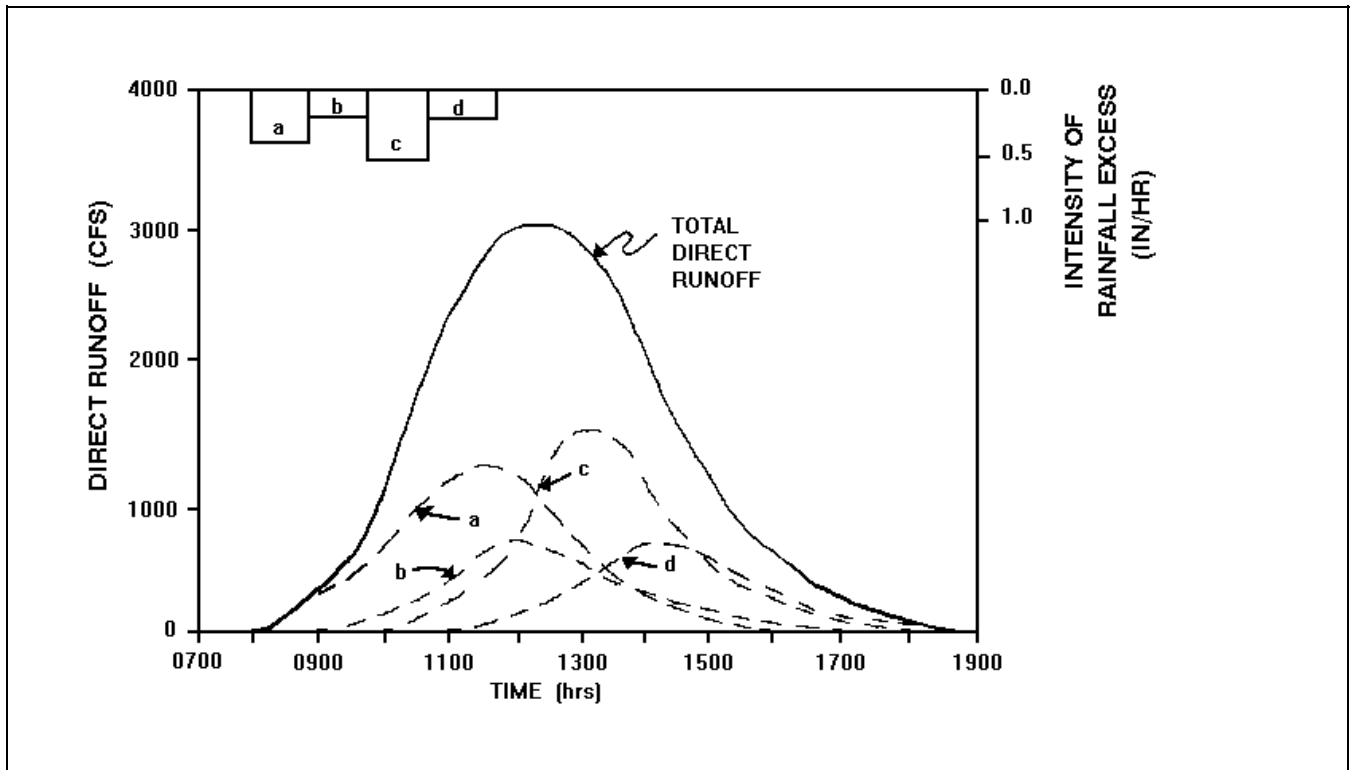

Figure 7-1. Superposition of direct runoff hydrographs

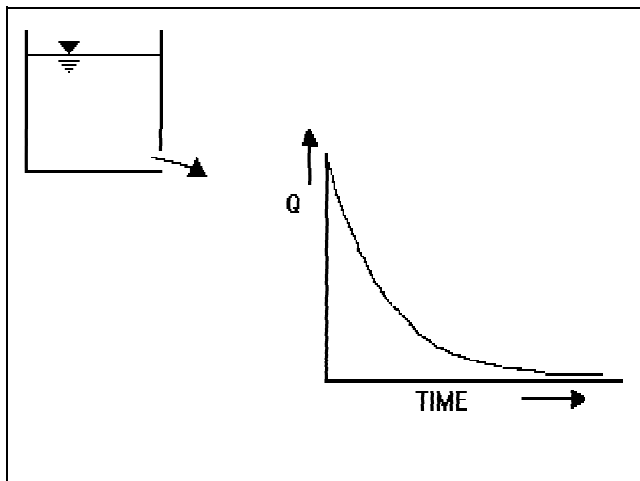

Figure 7-2. Single-linear reservoir model

(3) Clark model. The Clark conceptual model (Clark 1945) differs from the SLR and Nash models in that effects of basin shape (and other factors) on time of travel can be taken into account. As with the previous models, a unit of precipitation excess occurs instantaneously over the basin. A *translation hydrograph* at the basin outlet is developed by translating (lagging) the excess based on travel time to the outlet. The translation hydrograph is

routed through a single linear reservoir, and the resulting outflow represents the IUH for the basin. Figure 7-4 illustrates the components of the Clark method.

(a) The translation hydrograph can be conveniently derived from a time-area relation, for which area is the accumulated area from the basin outlet, and time is the travel time as defined by isochrones (contours of constant time-of-travel). Such a relationship can be expressed in dimensionless form with area as a percent of total basin area and time as a percent of time of concentration (t_c). The translation hydrograph can be obtained by determining from a time-area relation the portion of the basin that contributes runoff at the outlet during each time interval after the occurrence of the instantaneous burst of unit excess. The contributing area associated with a time interval (times the unit depth and divided by the time interval) yields an average discharge. This is the ordinate of the translation hydrograph for that interval.

(b) Isochrones for use in defining the translation hydrograph may be developed by estimating, for a number of points in the basin, overland flow and channel travel times to the basin outlet. A simpler approach is to assume a constant travel velocity and base the position of isochrones on travel distance from the basin outlet, in

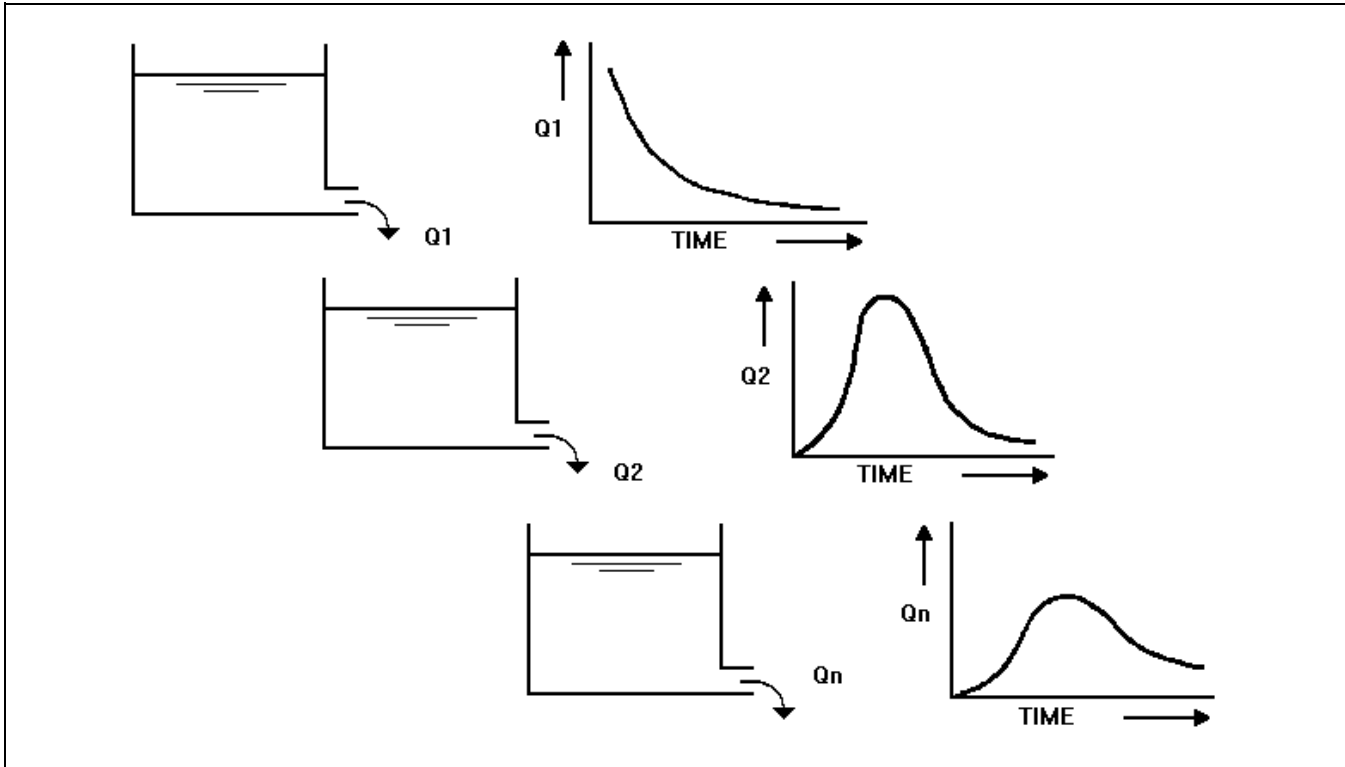

Figure 7-3. Cascade of linear reservoirs (Nash model)

which case the translation hydrograph reflects only basin shape.

(c) An even simpler approach is to use a translation hydrograph that is based on a standard basin shape, such as an ellipse. For many basins, storage effects represented by the linear reservoir cause substantial attenuation of the translation hydrograph such that the IUH is not very sensitive to the shape of the translation hydrograph. However, for a basin without a substantial amount of natural storage, such as a steep urban basin, the IUH will be much more sensitive to the shape of the translation hydrograph. For such a basin, the use of a standard shape may not be appropriate.

(d) The routing of the translation hydrograph through a linear reservoir is based on simple storage routing by solving the continuity equation. An equation for the routing is:

$$O(t) = C_a I + C_b O(t - 1) \quad (7-5)$$

The coefficients C_a and C_b are defined by:

$$C_a = \frac{\Delta t}{R + .5\Delta t}$$

and

$$C_b = 1 - C_a$$

where

$O(t)$ = ordinate of IUH at time t

I = ordinate of translation hydrograph for interval $t - 1$ to t

R = storage coefficient for linear reservoir

Δt = time interval with which IUH is defined

The two parameters for the Clark method are T_c , the time of concentration (and time base for the translation hydrograph), and R , the storage coefficient for the linear

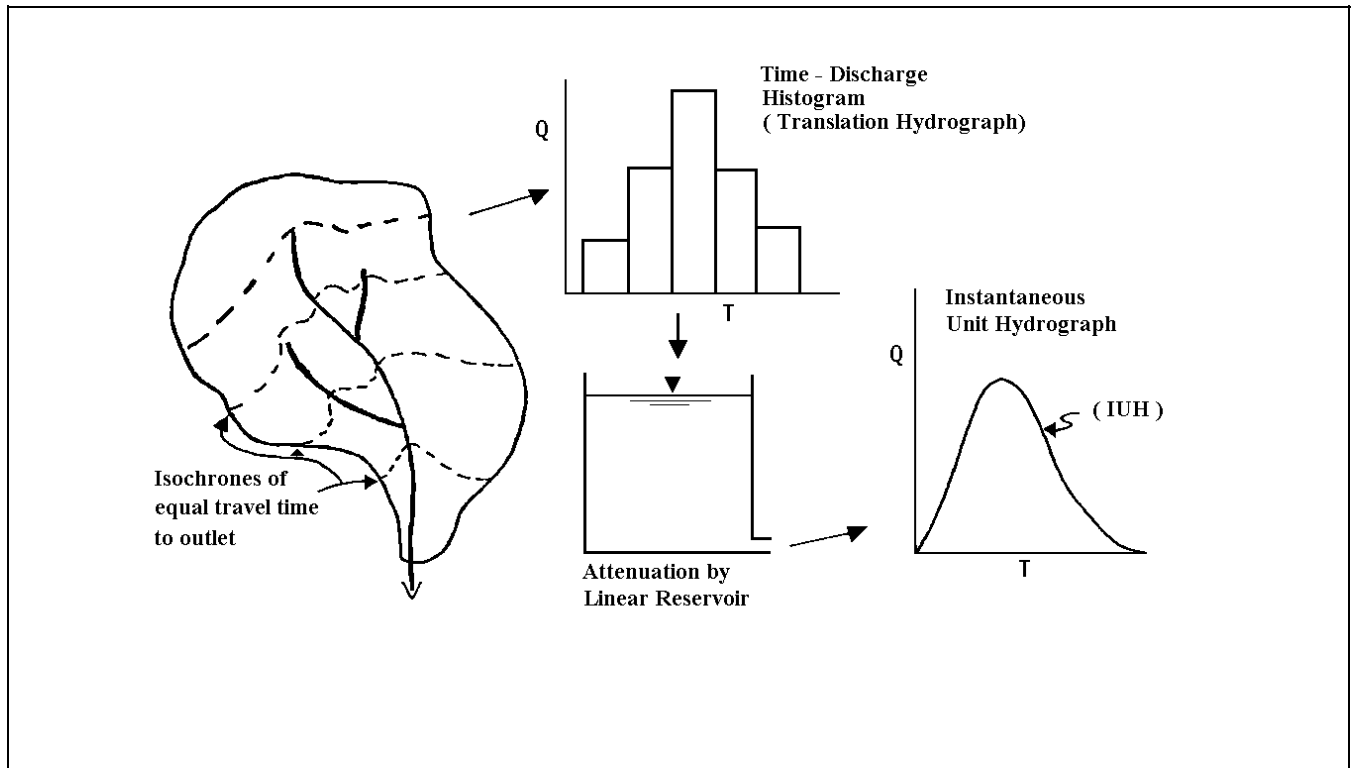

Figure 7-4. Clark model

reservoir. Values for these, along with a time-area relation, enable the determination of a unit hydrograph.

(e) To calculate direct runoff, the IUH can be converted to a unit hydrograph (UH) of finite duration. Derivation of a UH of specified duration from the IUH is accomplished using techniques similar to those employed to change the duration of a UH. For example, if a 2-hour UH is required, a satisfactory approximation may be obtained by first summing the ordinates of two instantaneous unit hydrographs, one of which is lagged 2 hr. This sum represents the runoff from 2 in. of excess precipitation; to obtain the required UH, the ordinates must be divided by 2. This procedure is illustrated in Figure 7-5.

(4) Snyder method. The Snyder method (Snyder 1938) provides equations that define characteristics of the unit hydrograph directly without the use of a conceptual model. Equations have been developed to define the coordinates of the peak and the time base of the unit hydrograph. Empirical procedures for defining the unit hydrograph width at 50 and 75 percent of the peak discharge have also been developed. Use of this method

requires, as a final step, the fitting of a curve (i.e., the unit hydrograph) that has an underlying area consistent with a unit depth over the basin area.

(a) The principal equations of the Snyder method from which the peak of the unit hydrograph can be defined are:

$$t_l = C_t (LL_{ca})^{0.3} \quad (7-6)$$

and

$$Q_p = \frac{640 C_p A}{t_l} \quad (7-7)$$

where

t_l = lag of the "standard" unit hydrograph, in hours

C_t = empirical coefficient

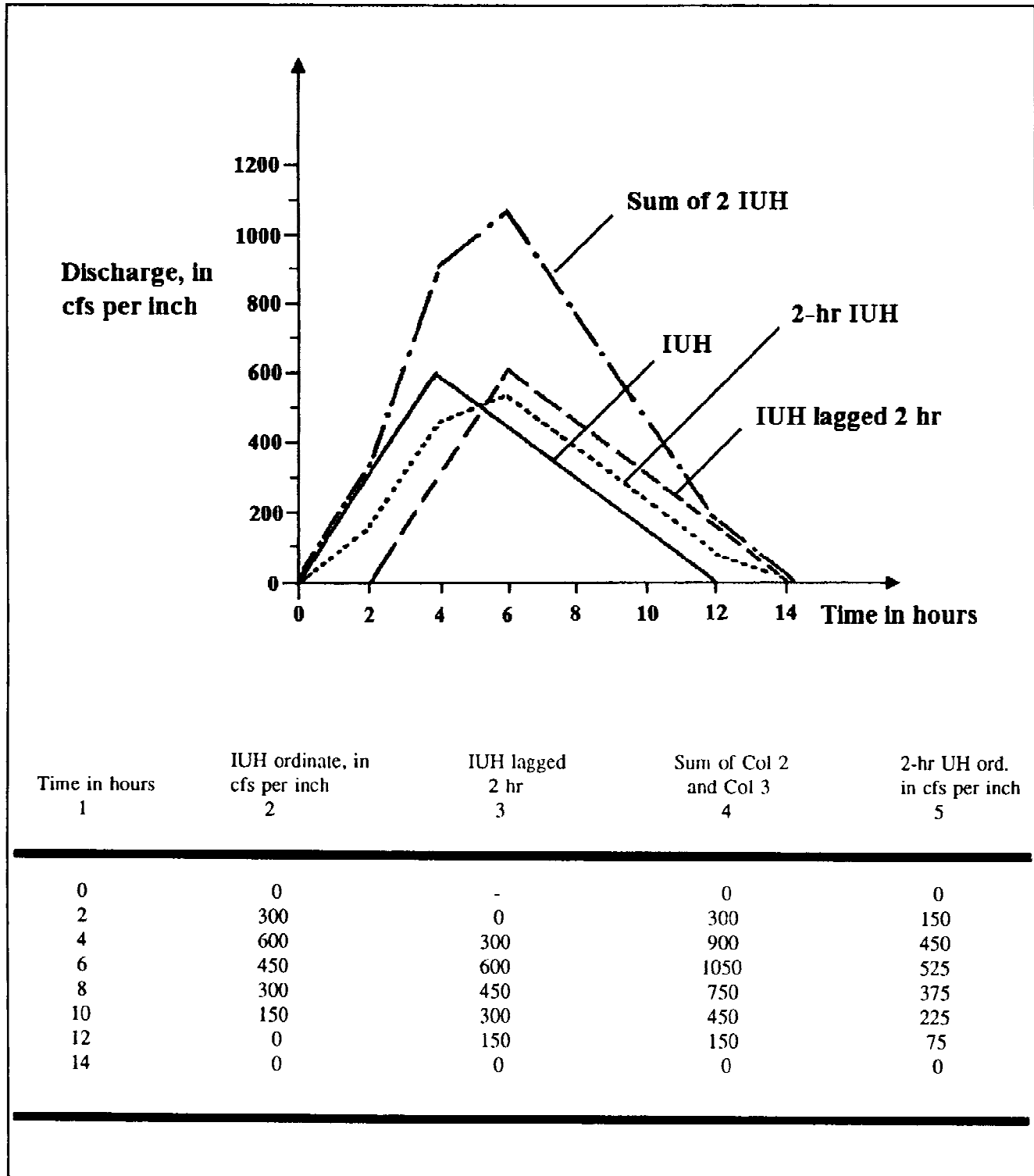

Figure 7-5. Conversion of IUH to UH with specific duration

L = length of main watercourse from basin outlet to upstream boundary of basin, in miles

L_{ca} = length of main watercourse from basin outlet to point opposite centroid of basin area, in miles

Q_p = peak discharge of "standard" unit hydrograph, in cubic feet per second

C_p = empirical coefficient

A = basin area, in square miles

The "standard" unit hydrograph is one for which the following relation holds:

$$t_r = \frac{t_l}{5.5} \quad (7-8)$$

where

t_r = duration of unit excess

t_l = time from the center of mass of the unit excess to the time of the peak of the unit hydrograph

The time at which the peak of the unit hydrograph occurs is therefore $t_l + t_r/2$. Thus, the above equations can be used to determine the coordinates of the peak of the "standard" unit hydrograph in terms of two empirical coefficients, C_l and C_p . The following equations can be used to develop the coordinates of the peak of a unit hydrograph of any other duration, t_R :

$$t_{lR} = t_l + 0.25(t_R - t_r) \quad (7-9)$$

$$Q_p = \frac{640 C_p A}{t_{lR}} \quad (7-10)$$

where

t_{lR} = adjusted lag time for unit hydrograph of duration t_R , in hours

t_l = original unit hydrograph lag time, in hours

t_R = desired unit hydrograph duration, in hours

t_r = original unit hydrograph duration, in hours

Q_p = peak discharge of unit hydrograph of duration t_R

Equations for the time base and widths of the unit hydrograph are available in several publications (Snyder 1938 and Chow, Maidment, and Mays 1988).

(b) The original development of this method and values for the coefficients C_l and C_p were made with data from the Appalachian Mountain region. Subsequent applications in other regions produced values for the coefficients that were substantially different. The coefficients should be calibrated with data from the region in which they will be applied. Indeed it is not necessary to adopt the form of the original equation for t_l ; regression analysis can be used to develop expressions for t_l and C_p that take into account measurable basin characteristics other than L and L_{ca} . For example, the variable $(LL_{ca}/S^{1/2})$, where S is the slope of the main watercourse, has been found useful as an independent variable in relations for t_l . According to a number of studies, C_p tends to be fairly constant in a region.

(5) SCS dimensionless unit hydrograph. The SCS dimensionless unit hydrograph (Mockus 1957), which is shown in Figure 7-6, was derived from a large number of unit hydrographs developed with data from small rural basins. The ordinates are expressed as a ratio of the peak discharge, and the time scale is expressed as a ratio of the time-to-peak. The time base of the unit hydrograph is five times the time-to-peak.

(a) A characteristic of the dimensionless unit hydrograph is that 37.5 percent of the area under the hydrograph occurs from the origin to the peak. The rising limb of the hydrograph is well represented by a straight line. The following equation is based on an expression for the area of a triangle defined by a linear representation of the rising limb and a vertical line from the peak to the x-axis:

$$Q_p = \frac{484 A}{t_p} \quad (7-11)$$

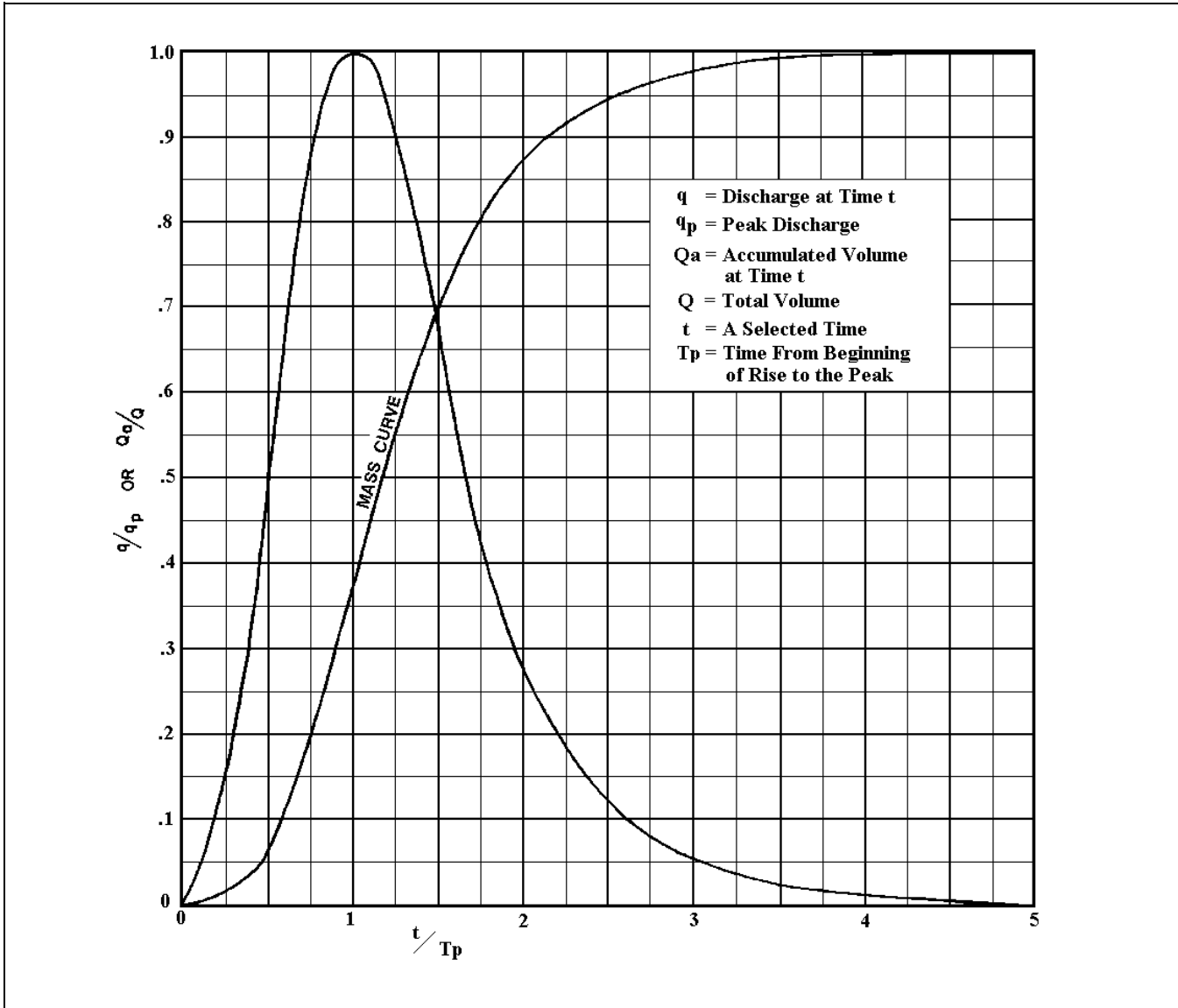

Figure 7-6. SCS dimensionless unit hydrograph

where

Q_p = peak discharge of unit hydrograph,
in cubic feet per second

A = basin area, in square miles

t_p = time-to-peak of unit hydrograph, in hours

(b) A change in volume under the rising limb of the unit hydrograph would be reflected in a change in the “constant” represented by 484 in the above equation. Studies have indicated that the constant varies from about 600 for basins with steep slopes to 300 for flat swampy basins. Figure 7-6 is based on the constant 484. To utilize a constant of 300 or 600, a completely new dimensionless hydrograph must be developed.

The time-to-peak may be expressed as:

$$t_p = \frac{D}{2} + t_l \quad (7-12)$$

where

D = duration of unit excess for unit hydrograph

t_l = lag, defined as the time from the centroid of precipitation excess to the time of the peak of the unit hydrograph

The SCS developed the following empirical relation between t_l and time of concentration:

$$t_l = 0.6t_c \quad (7-13)$$

where t_c = time of concentration. Thus, if the time of concentration for a basin can be estimated, the above equation can be used to estimate lag, and the preceding two equations can be used to determine the time-to-peak and peak discharge. The coordinates of the dimensionless unit hydrograph can then be used to completely determine the unit hydrograph.

d. Choice of synthetic unit hydrograph method. The preceding section describes five methods for defining a unit hydrograph in terms of parameters. The SLR method employs one parameter, a storage coefficient for a linear reservoir. The SCS method is a one-parameter method if the value of 484 is adopted for the constant in the equation for peak discharge. The Nash, Clark, and Snyder methods each employ two parameters, and the Clark method, in addition, requires a time-area relation.

(1) Figure 7-7 shows a set of unit hydrographs developed by the Clark method and also a unit hydrograph developed with the SCS dimensionless unit hydrograph (based on the 484 constant). The unit hydrographs are for a drainage area of 50 sq mi and a time of concentration of 13.3 hr. The parameter that varies for the Clark unit hydrographs is the storage coefficient, R . Each of the Clark unit hydrographs is labeled with a value for the ratio $R/(t_c + R)$. This dimensionless ratio has been found in a number of studies to be fairly constant on a regional basis. For a value of this ratio of 0.1, the unit hydrograph rises steeply and might be representative of the runoff response of an urban basin. For a value of 0.7, the unit hydrograph is much attenuated and might be representative of a flat swampy basin. The point is that with two

parameters, there is substantial flexibility for fitting a wide variety of runoff responses. Similar plots could be developed with the Nash and Snyder methods.

(2) If the SCS dimensionless unit hydrograph is applied as a one-parameter method (by adopting a constant of 484 in the equation for peak discharge), the result is as shown in Figure 7-7 for the given basin area and time of concentration. In this case, the unit hydrograph is approximately equivalent to a Clark unit hydrograph corresponding to a value for $R/(t_c + R)$ of about 0.25. Use of a one-parameter unit hydrograph can be very limiting with respect to ability to fit the runoff response characteristics of a basin.

(3) A number of attempts have been made to relate parameters of a synthetic unit hydrograph to measurable characteristics of an observed hydrograph. For example, the time of concentration (t_c) can be estimated as the time from the end of a burst of precipitation excess to the point of inflection on the falling limb of the direct runoff hydrograph. The storage coefficient in the Clark method can be estimated by dividing the discharge at the point of inflection by the slope of the direct runoff hydrograph at that point. The basis for these estimation procedures is that, at the point of inflection, inflow to storage has ceased, and from that time on, storage is being evacuated. At the point of inflection, the continuity equation can be stated as:

$$O_{poi} = - \left(\frac{dS_{poi}}{dt} \right) \quad (7-14)$$

where the subscript *poi* indicates "point of inflection." Since from the storage equation, $S = RO$, then:

$$O_{poi} = -R \left(\frac{dO_{poi}}{dt} \right) \quad (7-15)$$

Solving for R :

$$R = - \frac{O_{poi}}{dO_{poi}/dt} \quad (7-16)$$

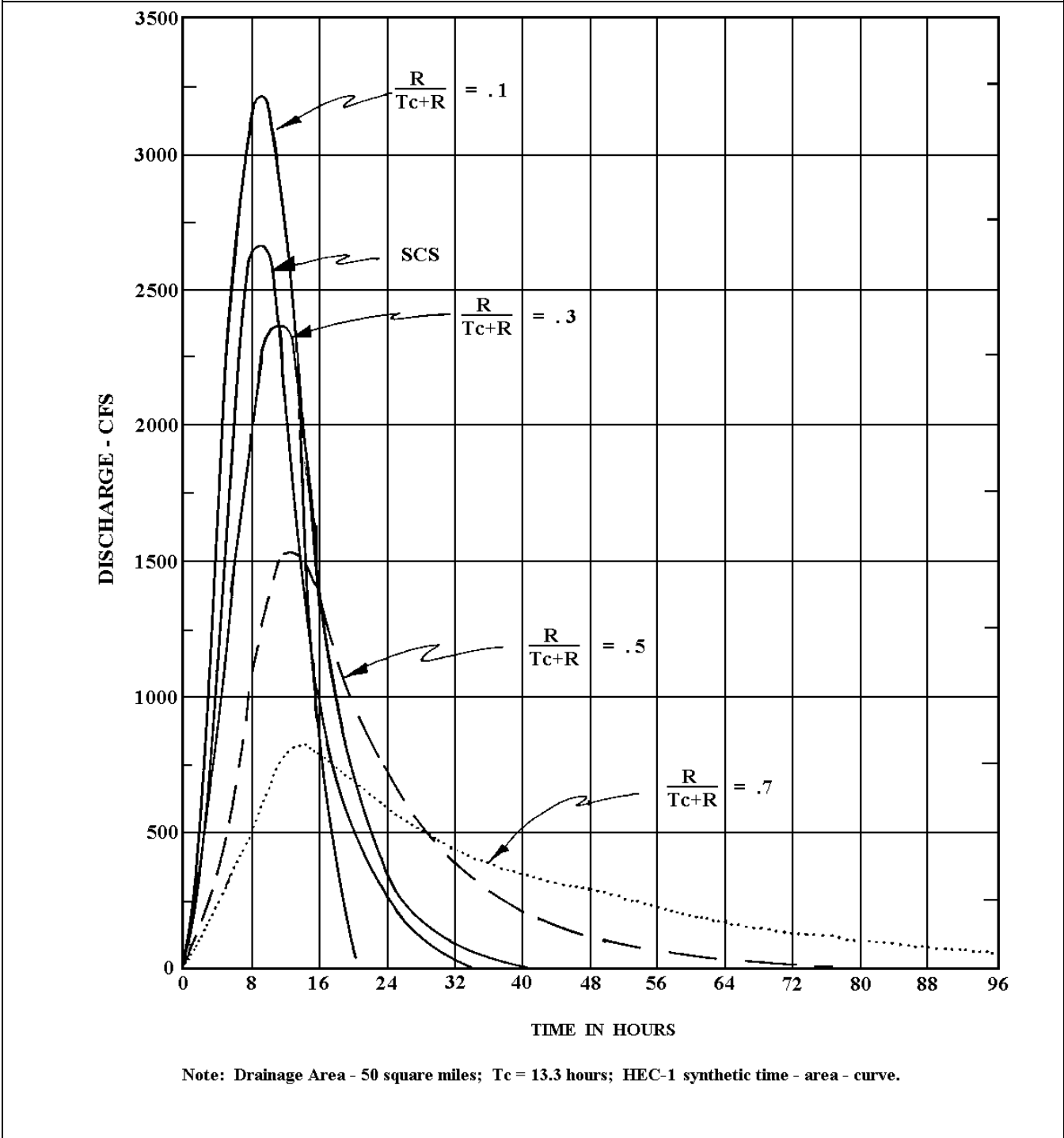

Figure 7-7. Unit hydrographs by Clark and SCS methods

Estimates obtained by such methods should not be relied on too rigorously because the conceptual models are only crude approximations at best of real-world phenomena.

(4) Any one of the two-parameter methods is adequate for describing the runoff response of most basins. The choice of method therefore can be based on other factors, such as availability of regional relations for parameters, familiarity with a method, or ease of use. Other aspects of the methods should be considered. For example, the Snyder method requires explicit curve fitting, and the Clark method permits incorporation of basin shape and timing factors through use of a time-area relation.

e. Unit hydrograph for a gauged basin. A number of methods have been developed to enable derivation of a unit hydrograph from precipitation and streamflow data. The simplest method involves the analysis of individual storms for which there are isolated blocks of significant amounts of precipitation excess. After base flow separation, the volume of direct runoff is determined and used to adjust losses to produce an equivalent volume of precipitation excess. The duration of precipitation excess is associated with a unit hydrograph that is obtained by dividing the ordinates of direct runoff by the volume of direct runoff expressed as an average depth over the basin. S-graph methods can be used to convert the unit hydrograph of a given duration to one of another duration. The “isolated storm” and S-graph methods are described in basic hydrology textbooks.

(1) Matrix methods. A unit hydrograph can be derived from a complex storm (for which there are several blocks of precipitation excess) by matrix methods. The first step is to perform a base flow separation on the observed hydrograph and to develop a precipitation excess hydrograph. Equations are written to define the ordinates of the direct runoff hydrograph as a function of hydrograph ordinates and (unknown) unit hydrograph ordinates, and these equations are solved with matrix algebra. Linear regression or optimization methods can be used to facilitate the search for a unit hydrograph that minimizes the error in the fitted direct runoff hydrograph (Chow, Maidment, and Mays 1988). A problem with such techniques is that the derived unit hydrograph may have an oscillatory shape or reflect other irregularities, and a smoothing process is commonly required.

(2) Optimization of values for unit hydrograph parameters. The methods described thus far produce a unit hydrograph defined by its ordinates. Another approach is to use a synthetic hydrograph technique and

associated parameters to represent the unit hydrograph. The problem then becomes one of finding values for the parameters, generally using trial and error procedures with data from complex storms. The objective of such procedures is to obtain parameter values that enable a “best fit” of the observed hydrograph.

(a) Optimization methods have been developed for automated estimation of values for parameters. Such methods can optimize values for loss rate parameters simultaneously with values for unit hydrograph parameters (Ford, Merris, and Feldman 1980). A general scheme is shown in Figure 7-8. A quantitative measure of “best fit,” termed an *objective function*, is calculated with each trial set of parameters. The optimization scheme is designed to adjust parameter values in such a way that minimization of the objective function is achieved. One such objective function is:

$$F = \left[\frac{\sum_{i=1}^n (Q_{obs_i} - Q_{comp})^2 * WT_i}{n} \right]^{1/2} \quad (7-17)$$

where

F = objective function

Q_{obs} = ordinate of observed hydrograph

Q_{comp} = ordinate of computed hydrograph

i = ordinate number

n = total number of ordinates over which objective function is evaluated

and

$$WT_i = \frac{(Q_{obs_i} + Q_{avg})}{2 * Q_{avg}} \quad (7-18)$$

where Q_{avg} = average of the observed-hydrograph ordinates. The purpose of the weighting function, WT_i , is to weight deviations between observed and computed ordinates more heavily for higher observed discharges. This will tend to produce a relatively good fit for high

discharges compared with low discharges, which is generally desired in flood-runoff analysis.

(b) Optimization procedures also require initial values for parameters and constraints that define the acceptable range of magnitude of each parameter. The results of optimization should be reviewed carefully, both with respect to the success of the optimization and the reasonableness of optimized values.

(3) Procedure for unit hydrograph development. A procedure for developing a unit hydrograph for a gauged basin is given below. It is presumed that the analysis will be performed with the aid of a computer program that has capabilities for optimizing values of runoff parameters.

(a) Obtain precipitation and discharge data for historical storms. It is desirable for the storms to be of comparable magnitude to those to which the unit hydrograph will be applied. In the case of application with very large hypothetical storms, data for the largest storms of record will be the most useful. Ideally, it would be desirable to calibrate values for unit hydrograph parameters for about five storms and to verify the adopted values with data from about three additional storms.

(b) Determine initial streamflow conditions for each historical event and appropriate values for parameters with which to define base flow. Select an appropriate method for representing losses and a synthetic unit hydrograph method. Choice of methods will be dependent on the capabilities of computer software to be used for the analysis.

(c) Perform an optimization of values for loss and unit hydrograph parameters for each storm that has been selected for calibration. Carefully review optimization results and verify that optimized values are reasonable. Extend the analysis (for example with different initial values) as appropriate.

(d) Based on a review of values for unit hydrograph parameters that have been optimized for each calibration event, adopt a single set of values. Factors to consider in adopting values include the quality of fit of an observed hydrograph and the magnitude of the event. Events for which only a poor fit was possible would be given less weight in the adoption process. If some events are substantially larger than others, these might be given more weight, if the adopted values are intended for use with large events. The adopted values should then be used to calculate hydrographs for all of the calibration events, and the results evaluated. Additional adjustment of the values

might be warranted to achieve the most satisfactory fitting of the events.

(e) If additional events for verification are available, the adopted values should be used to calculate hydrographs for these events. The quality of results will be a measure of the reliability of the adopted values. Additional adjustment of the values may be appropriate.

7-4. Kinematic Wave Approach

a. Concepts. The application of the kinematic wave method differs from the unit hydrograph technique in the following manner. First, the method takes a distributed view of the subbasin rather than a lumped view, like the unit hydrograph approach. The distributed view point allows the model to capture the different responses from both pervious and impervious areas in a single urban subbasin. Second, the kinematic wave technique produces a nonlinear response to rainfall excess as opposed to the linear response of the unit hydrograph.

(1) When applying the kinematic wave approach to modeling subbasin runoff, the various physical processes of water movement over the basin surface, infiltration, flow into stream channels, and flow through channel networks are considered. Parameters, such as roughness, slope, area, overland lengths, and channel dimensions are used to define the process. The various features of the irregular surface geometry of the basin are generally approximated by either of two types of basic flow elements: an overland flow element, or a stream- or channel-flow element. In the modeling process, overland flow elements are combined with channel-flow elements to represent a subbasin. The entire basin is modeled by linking the various subbasins together.

(2) In a typical urban system, as shown in Figure 7-9, rain falls on two types of surfaces: those that are essentially impervious, such as roofs, driveways, sidewalks, roads, and parking lots; and pervious surfaces, most of which are covered with vegetation and have numerous small depressions which produce local storage of rainfall. The contribution to the flood hydrograph of open areas (pervious surfaces) is characteristically different than that from impervious areas. An obvious difference is that the open areas can infiltrate rainfall whereas the impervious areas do not infiltrate significant amounts. A less obvious difference is that the open areas are not sewered as heavily as impervious areas, making for longer overland flow paths to major conveyances such as open channels and storm sewers. Furthermore, the open areas

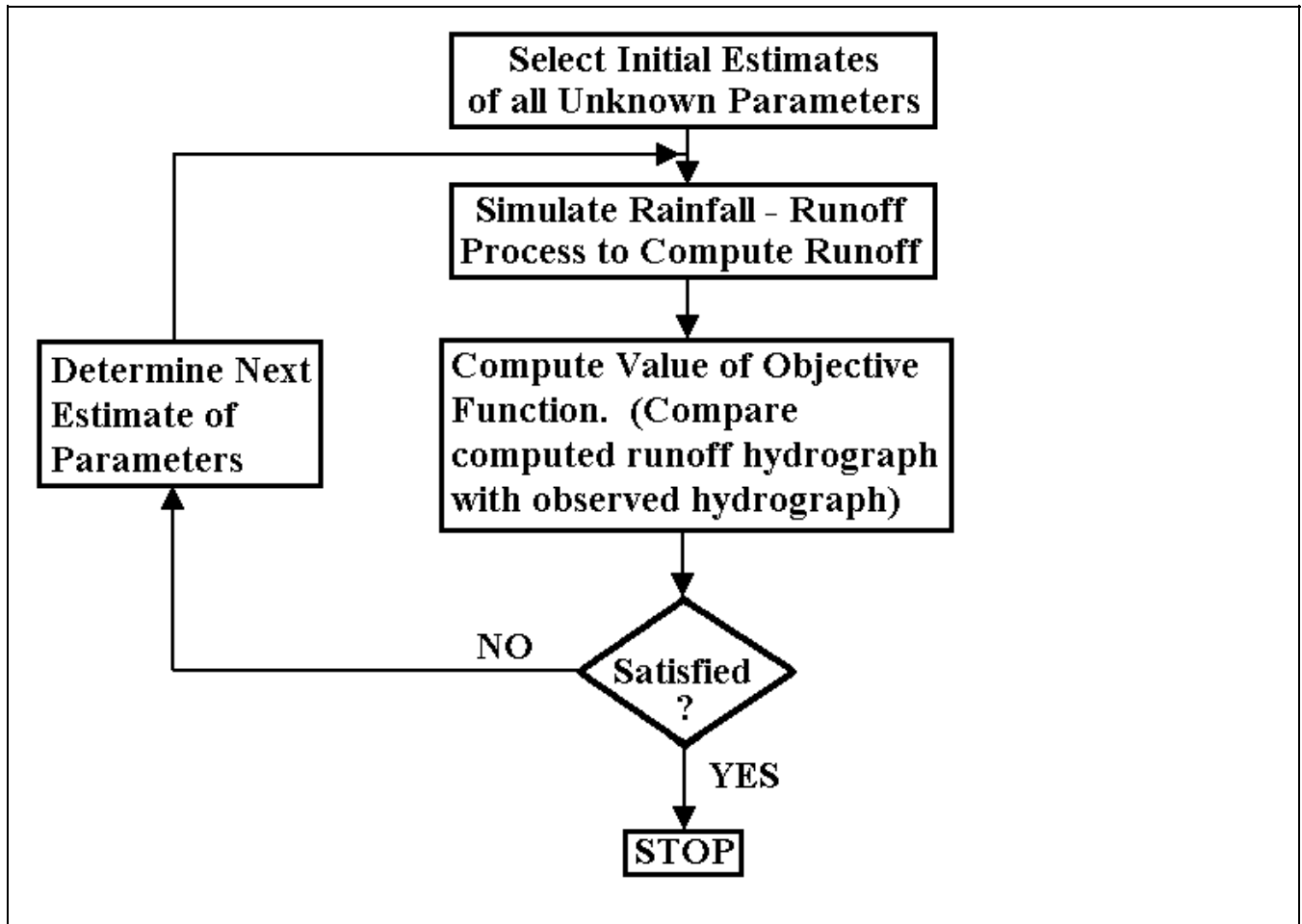

Figure 7-8. Procedure for parameter optimization

have hydraulically rougher surfaces which impedes the flow to a greater extent than the relatively smoother surface of the paved areas. The overall impact of these differences is to cause the runoff from the impervious areas to have significantly shorter times of concentration, larger peak discharges, and volumes per unit area than from open (pervious) areas.

(3) The lumped approach to modeling this type of basin (Figure 7-9) would average the runoff characteristics of both the open and impervious areas into one unit hydrograph. In performing this averaging operation, the peak runoff response of the basin will normally be underestimated when the impervious area is the dominant contributor to the runoff hydrograph. The main advantage of the kinematic wave method is that the response of both the open and impervious areas can be accounted for in a single subbasin.

b. The kinematic wave equations of motion. The kinematic wave equations are based on the conservation of mass and the conservation of momentum. The conservation principles for one-dimensional open channel flow (St. Venant equations) can be written in the following form:

Conservation of mass

Inflow - outflow = the rate in change of channel storage

$$A \frac{\partial V}{\partial x} + VB \frac{\partial y}{\partial x} + B \frac{\partial y}{\partial t} = q \quad (7-19)$$

Conservation of momentum

Sum of forces = gravity + pressure + friction
= mass x fluid acceleration

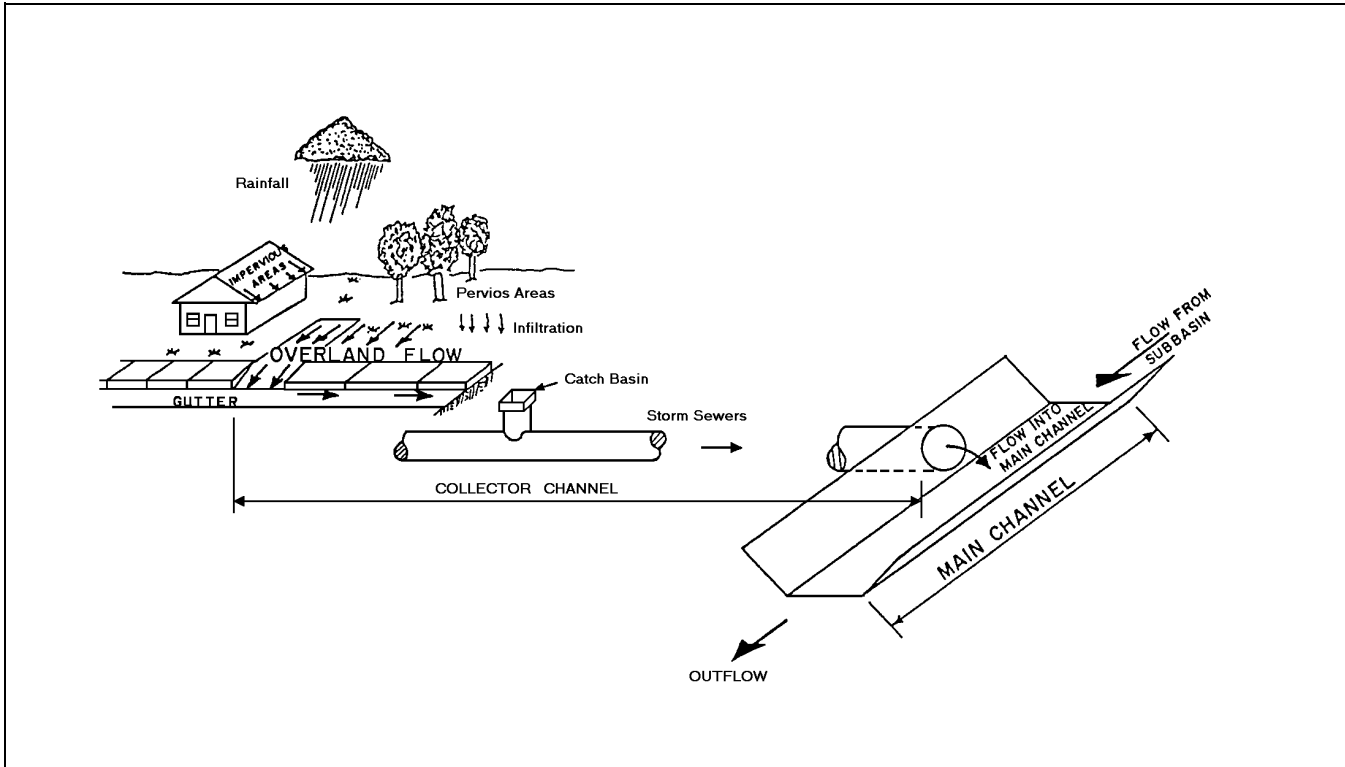

Figure 7-9. Typical urban basin flow paths

$$S_f = S_o - \frac{\partial y}{\partial x} - \frac{V}{g} \frac{\partial V}{\partial x} - \frac{1}{g} \frac{\partial V}{\partial t} \quad (7-20)$$

where

A = cross-sectional flow area

V = average velocity of water

x = distance along the channel

B = water surface width

y = depth of water

t = time

q = lateral inflow per unit length of channel

S_f = friction slope

S_o = channel bed slope

g = acceleration due to gravity

The kinematic wave equations are derived from the St. Venant equations by preserving conservation of mass and approximately satisfying conservation of momentum. In approximating the conservation of momentum, the acceleration of the fluid and the pressure forces are presumed to be negligible in comparison to the bed slope and the friction slope. This reduces the momentum equation down to a balance between friction and gravity:

Kinematic wave conservation of momentum
Frictional forces = gravitational forces

$$S_f = S_o \quad (7-21)$$

This equation states that the momentum of the flow can be approximated with a uniform flow assumption as described by Manning's and Chezy's equations. Manning's equation can be written in the following form:

$$Q = \alpha A^m \quad (7-22)$$

where α and m are related to surface roughness and flow geometry. Since the momentum equation has been reduced to a simple functional relationship between area and discharge, the movement of a floodwave is described solely by the continuity equation. Therefore, the kinematic wave equations do not allow for hydrograph diffusion (attenuation). Hydrographs routed with the kinematic wave method will be translated in time but will not be attenuated. The kinematic wave equations are usually solved by explicit or implicit finite difference techniques. Any attenuation of the peak flow that is computed using the kinematic wave equations is due to errors inherent in the finite difference solution scheme. In spite of this limitation, the kinematic wave approximation is very good for modeling overland flow at shallow depths or channel flow in moderately steep channels. Application of the kinematic wave equations to a combination of overland flow and channel flow elements is often used in urban watershed modeling.

c. Basin representation with kinematic wave elements. The contribution to the flood hydrograph from open and impervious areas within a single subbasin is modeled in the kinematic wave method by using different types of elements as shown in Figure 7-10.

(1) The kinematic wave elements shown are an overland flow plane, collector, and main channel. In general, subbasin runoff is modeled with kinematic wave elements by taking an idealized view of the basin. Rather than trying to represent every overland flow plane and every possible collector channel, subbasins are depicted with overland flow planes and channels that represent the average conditions of the basin. Normally two overland flow planes are used, one to represent the pervious areas and one to represent the impervious areas. The lengths, slopes, and roughnesses of the overland flow planes are based on the average of several measurements made within the subbasin. Likewise, collector channels are normally based on the average parameters of several collector channels in the subbasin.

(2) Various levels of complexity can be obtained by combining different elements to represent a subbasin. The simplest combination of elements that could be used to represent an urban subbasin are two overland flow planes and a main channel (Figure 7-11). The overland flow planes are used to separately model the overland flow from pervious and impervious surfaces to the main channel. Flow from the overland flow planes is input to the main channel as a uniform lateral inflow. Urban watersheds typically have various levels of storm sewers, man-made channels, and natural streams. To model

complex urban systems in a manageable fashion, the concept of typical collector channels must be employed. As shown in Figure 7-12, the complexity of an urban subbasin can be modeled by combining various levels of channel elements. An idealized overland flow, sub-collector, and collector system are formulated from average parameters in the subbasin. The runoff contributing to the idealized collector system is assumed to be typical of the subbasin. The total runoff is obtained by multiplying the runoff from the idealized collector system by the ratio of the total subbasin area to the contributing area to the collector system. The total runoff is then distributed uniformly along the main channel and routed to the outlet.

d. Estimating kinematic wave parameters. Although the kinematic wave equations are used to route flow through both the overland flow planes and channels, different types of data are needed for each element because of differences in characteristic depths of flow and geometry. The depth of flow over an overland flow plane is much shallower than in the case of a channel. This results in a much greater frictional loss for overland flow than for channel flow. Frictional losses are accounted for in the kinematic wave equations through Manning's equation. Typical roughness coefficients for overland flow are about an order of magnitude greater than for channel flow. The overland flow roughness coefficients (Table 7-1) will range between 0.1 and 0.5 depending on the surface cover; whereas the roughness coefficients for channel flow are normally in the range of 0.012 to 0.10.

(1) The estimation of kinematic wave parameters for each element is an exercise in averaging slopes, lengths, roughness coefficients, and even geometry. The data for the various kinematic wave parameters can be obtained from readily available topographic, soil, sewer, and zoning maps, as well as tables of roughness coefficients. The following data are needed for each overland flow plane:

- (a) Average overland flow length.
- (b) Representative slope.
- (c) Average roughness coefficient (Table 7-1).
- (d) The percentage of the subbasin area which the overland flow plane represents.
- (e) Infiltration and loss rate parameters.

Overland flow lengths for impervious surfaces are typically shorter than those for pervious surfaces. Impervious overland flow lengths range from 20 to 100 ft, while

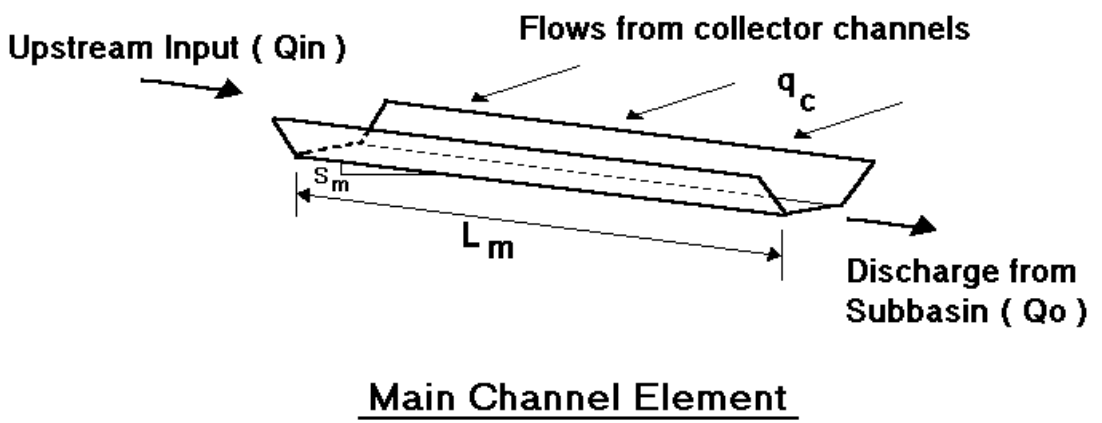
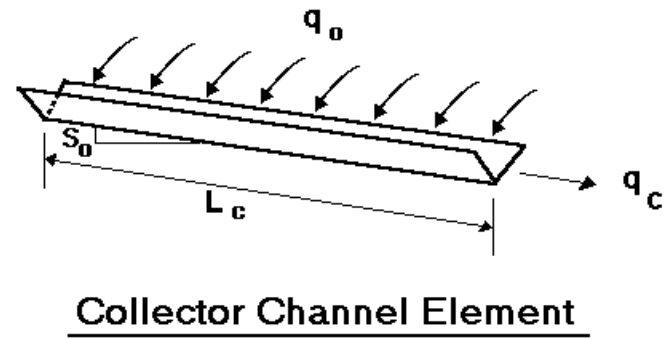
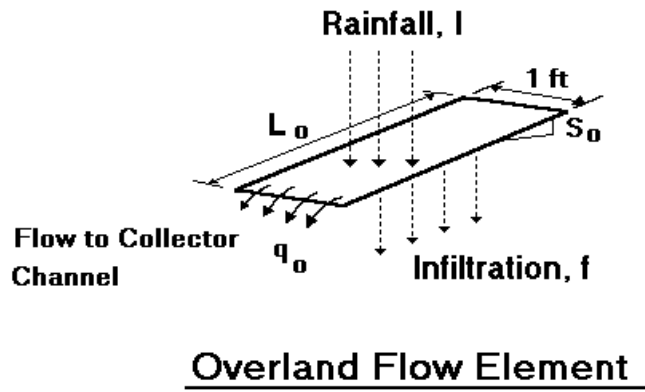

Figure 7-10. Kinematic wave elements

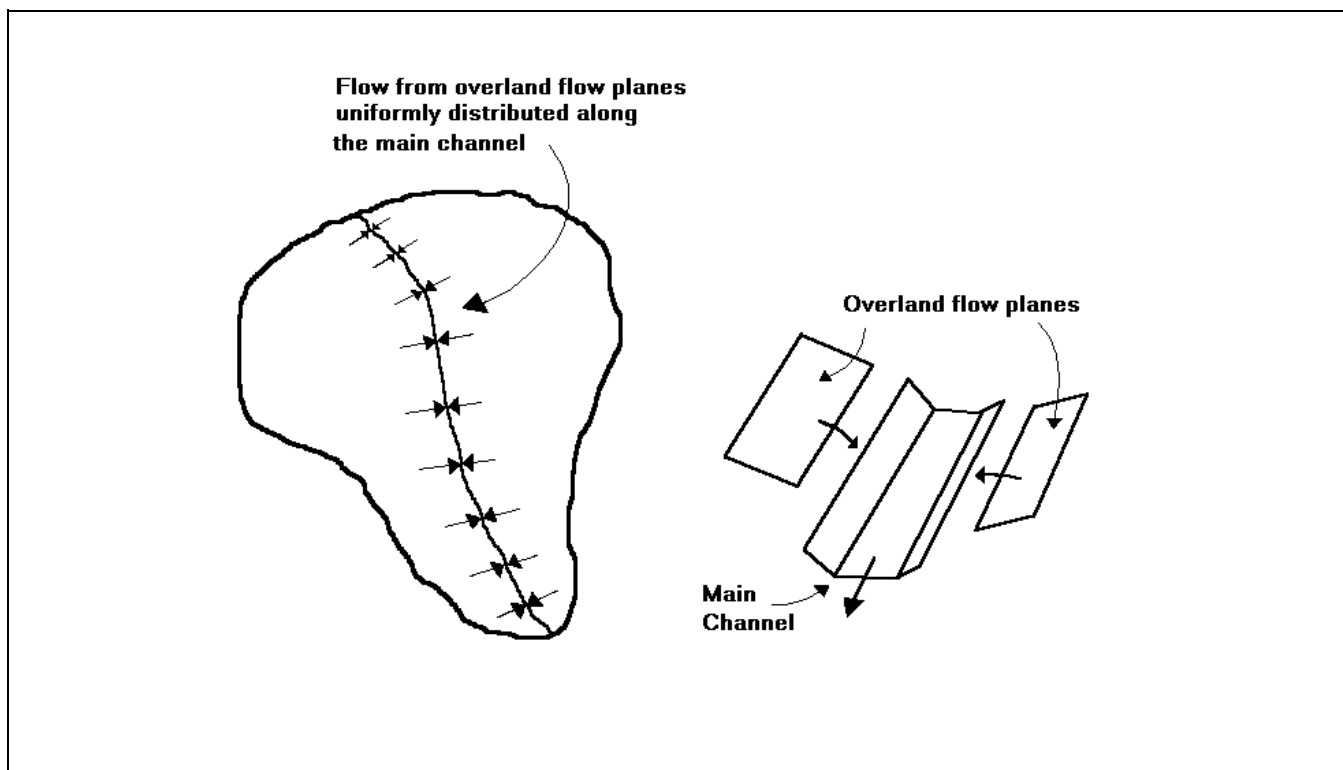

Figure 7-11. Simple kinematic wave subbasin model

pervious overland flow lengths can range from 20 to several hundred feet. Overland and channel slopes can be obtained from topographic maps. Overland slopes, as well as collector channels, should be taken as the average from several measurements made within a subbasin. The main channel slope can be measured directly. Loss rate parameters must be specified for each overland flow plane. Loss rates for impervious areas are generally restricted to a small initial loss to account for wetting the surface and depression storage. Loss rates for pervious areas are based on the soil types and surface cover. Estimating the percent of the subbasin that is actually impervious area can be quite difficult. For example, in some areas roof top downspouts are hydraulically connected to the sewers or drain directly to the driveway; whereas in other areas the downspouts drain directly into flower beds or lawns. In the former situation, the roof top acts as an impervious area, and in the latter, as a pervious area.

(2) The following data are needed to describe collector and sub-collector channels as well as the main channel:

- (a) Representative channel length.
- (b) Manning's n .

- (c) Average slope.
- (d) Channel shape.
- (e) Channel dimensions.
- (f) Amount of area serviced by the channel element.

For collector and subcollector channels, the representative length and slope is based on averaging the lengths of several collectors and subcollectors within the basin. The main channel length and slope should be measured directly from topographic maps. Manning's n values can be estimated from photos or field inspection of the channels. Channel shapes and dimensions are usually approximated by using simple prismatic geometry as shown in Table 7-2. Collector and subcollector channels should be based on the average of what is typical within the subbasin. The main channel shape and dimensions should be approximated as best as possible with one of the prismatic elements shown in Table 7-2.

e. Basin modeling. The assumptions made using the kinematic wave approach to model a river basin are essentially the same as those made when applying the unit

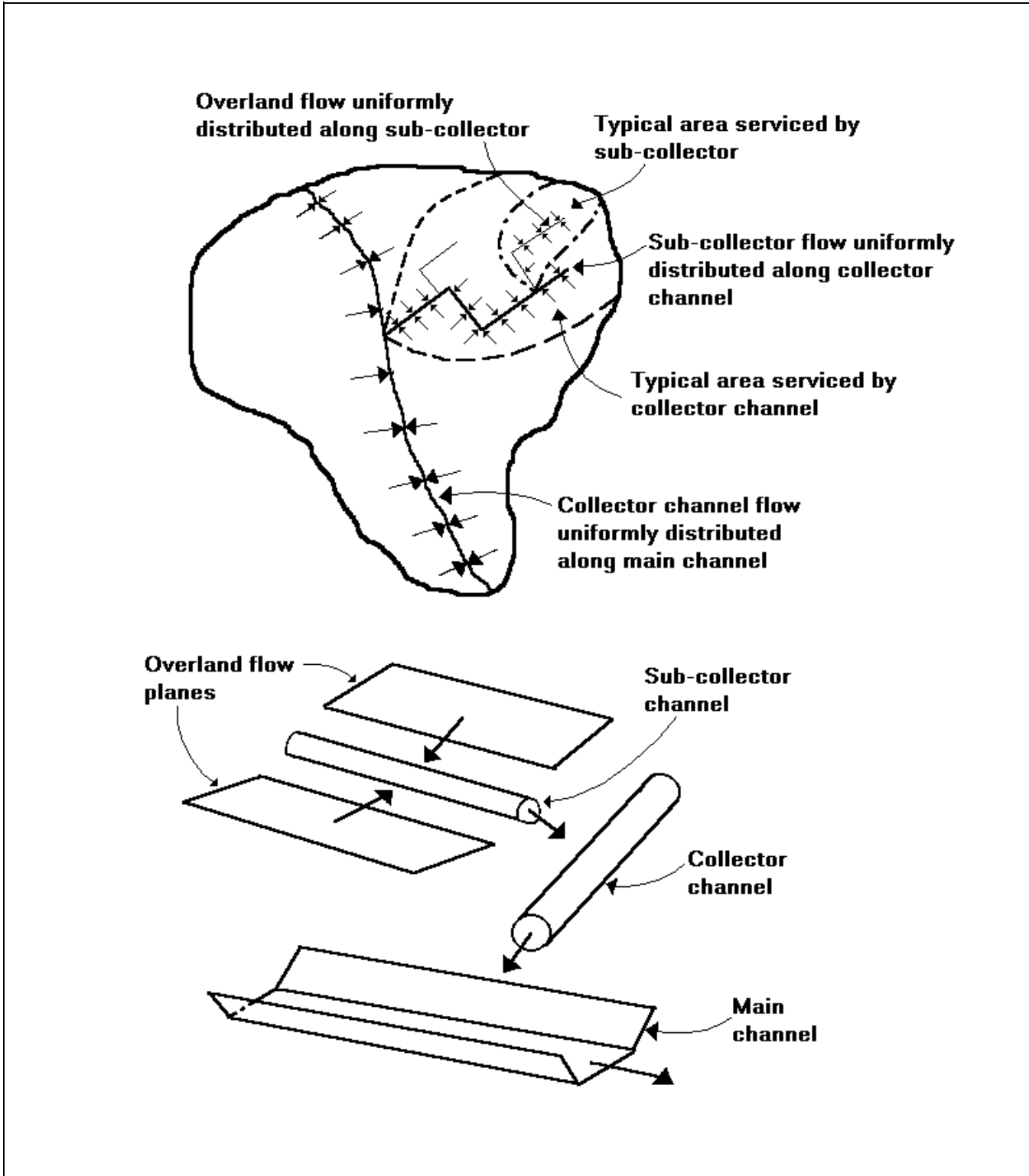

Figure 7-12. Kinematic wave representation of an urban subbasin

Table 7-1
Roughness Coefficients for Overland Flow (from Hjelmfelt 1986)

Surface	N Value	Source
Asphalt & concrete	0.05 - 0.15	a
Bare packed soil free of stone	0.10	c
Fallow - no residue	0.008 - 0.012	b
Conventional tillage - no residue	0.06 - 0.12	b
Conventional tillage - with residue	0.16 - 0.22	b
Chisel plow - no residue	0.06 - 0.12	b
Chisel plow - with residue	0.10 - 0.16	b
Fall disking - with residue	0.30 - 0.50	b
No till - no residue	0.04 - 0.10	b
No till (20 - 40 percent residue cover)	0.07 - 0.17	b
No Till (60 - 100 percent residue cover)	0.17 - 0.47	b
Sparse rangeland with debris:		
0 percent cover	0.09 - 0.34	b
20 percent cover	0.05 - 0.25	b
Sparse vegetation	0.053 - 0.13	f
Short grass prairie	0.10 - 0.20	f
Poor grass cover on moderately rough bare surface	0.30	c
Light turf	0.20	a
Average grass cover	0.40	c
Dense turf	0.17 - 0.80	a,c,e,f
Dense grass	0.17 - 0.30	d
Bermuda grass	0.30 - 0.48	d
Dense shrubbery and forest litter	0.40	a

- a) Crawford and Linsley (1966).
- b) Engman (1986).
- c) Hathaway (1945).
- d) Palmer (1946).
- e) Ragan and Dura (1972).
- f) Woolhiser (1975).

hydrograph technique. Rainfall is assumed to be uniform over any subbasin and there are no backwater effects in channel routing. The assumption that there are no backwater effects has some important ramifications for interpreting the kinematic wave results. Although the channel elements can be used to represent pipe elements, the pipes never pressurize. The kinematic wave equations are for open channel flow and cannot represent the effects of pressure flow.

(1) This is not a severe limitation when applying the kinematic wave method for design purposes. Generally speaking, sewer systems are designed to convey flow as an open channel. However, in situations where the sewer system will pressurize, flow will back up into the street gutters and flow to the nearest low point where it may enter the sewer system again. In the case where a culvert or a storm sewer pressurizes and creates a large

backwater, the backwater area should be modeled separately with a technique that can handle pressure flow.

(2) The use of the kinematic wave method for main channels and large collector's should be limited to urban areas or moderately sloping channels in headwater areas. The limitation results because a hydrograph's peak discharge does not attenuate when it is routed with the kinematic wave technique. This is an adequate approximation in urban areas, or any small, quick responding basin. However, flood waves generally attenuate in most natural channels. Consequently, the kinematic wave method will tend to overestimate peak discharges in this type of stream. Therefore, in natural streams, where it is likely that hydrograph attenuation will occur, the kinematic wave method should not be used for routing. Alternative routing methods that can account for attenuation, such as the Muskingum-Cunge method, should be applied instead.

Table 7-2
Prismatic Elements for Kinematic Wave Channels

Circle



$$\alpha = \frac{.804}{n} S^{1/2} D^{1/6}$$

$$m = 5/4$$

Triangle



$$\alpha = \frac{0.94}{n} S^{1/2} \left(\frac{Z}{1+Z^2} \right)^{1/3}$$

$$m = 4/3$$

Square

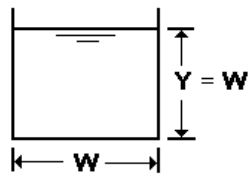

$$\alpha = \frac{0.72}{n} S^{1/2}$$

$$m = 4/3$$

Rectangular

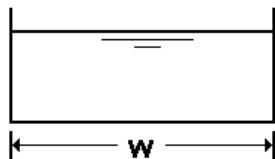

$$\alpha = \frac{1.49}{n} S^{1/2} W^{-2/3}$$

$$m = 5/3$$

Trapezoidal

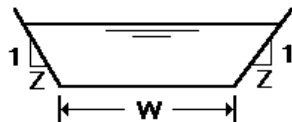

$$Q = \frac{1.49}{n} S^{1/2} A^{5/3} \left(\frac{1}{W+2Y\sqrt{1+Z^2}} \right)^{2/3}$$

Chapter 8 Subsurface Runoff Analysis

8-1. General

a. Subsurface runoff analysis considers the movement of water throughout the entire hydrologic cycle (Figure 8-1). The prediction of subsurface runoff is performed with models of varying complexity depending on the application requirements and constraints. The models used may be categorized as event-oriented or continuous simulation. Event-oriented models, which have been the focus of the previous chapters, utilize relatively simple techniques for estimating subsurface contributions to a flood hydrograph.

b. Continuous simulation models continuously account for the movement of water throughout the hydrologic cycle. Continuous accounting of water movement involves the consideration of precipitation, snow melt, surface loss, infiltration, and surface transport processes that have been discussed previously. Other processes that need to be considered are evapotranspiration, soil moisture redistribution, and groundwater transport. The integration of all these processes in a watershed model is usually termed as continuous soil moisture accounting (SMA). The complexity of the SMA model varies greatly depending on the degree of conceptualization employed in integrating the subsurface processes.

c. Historically, the representation of soil moisture redistribution and subsurface flows has been highly conceptualized in SMA algorithms by an interconnected system of storages. More recently, a more distributed or smaller scale representation has been attempted (e.g., the Systeme Hydrologique European SHE model, Abbott, et al. 1986). These models represent overland and subsurface flow with finite difference approximations to the St. Venant and Darcy equations. However, these techniques have not yet been widely applied and will not be covered in this manual. Instead, the focus will be on the more highly conceptualized representations of soil moisture redistribution and subsurface flow.

d. The purpose of this section is to discuss separately the continuous simulation and event oriented approaches to calculating subsurface flow. A topic important to both approaches is hydrograph recession analysis. The methods used for event-oriented modeling will be discussed initially in paragraph 8-2 because recession analysis is key to this approach.

e. The continuous simulation approach involves algorithms that consider a number of processes besides hydrograph recession. Evapotranspiration (ET) is a key element in performing continuous simulation. In paragraph 8-3, a separate discussion is provided on ET because the estimation methods vary greatly. In paragraph 8-4, a general discussion is provided of the approaches used in performing continuous simulation. In paragraph 8-5, the continuous simulation algorithms used in public domain models PRMS (U.S. Geological Survey (USGS) 1983) and SSARR (USACE 1987) are presented for example purposes. A general discussion of the techniques that might be used to estimate parameters in continuous simulation models is provided in paragraph 8-6.

8-2. Event-Oriented Methods

a. Basic model for hydrograph recession modeling. Event-oriented models do not have the capability to account for the subsurface water balance. Since the water balance is not known, these models use an empirical approach to relate model parameters to the recession characteristics of an observed hydrograph. Presumably, the recession of the hydrograph is dominated by subsurface response at the point where direct runoff from the surface and near surface ceases. The problem is identifying the point at which the direct runoff ceases.

(1) The separation of the hydrograph into direct runoff and subsurface response is termed base-flow separation. Base-flow separation methods assume a very simple model for the watershed geometry (Figure 8-2). The watershed response is assumed to be a sum of direct runoff and base flow due to aquifer discharge. The key assumption is that the aquifer is homogenous with a single characteristic response. This characteristic response should be identifiable from the hydrograph recession.

(2) The assumed characteristics of the base-flow recession are based on simplified equations for flow in a phreatic aquifer. The equations are obtained (Bear 1979) by applying the Dupuit-Forcheimer assumptions to a combination of Darcy's Law and conservation of mass which is known as the Boussinesq equation. These assumptions require the approximation that flow in the aquifer is essentially horizontal.

(3) The Boussinesq equation relates the spatial change in the square of the phreatic water surface elevation in space to its change in time. Interestingly, the Boussinesq equation results in no approximation in calculated aquifer discharge to a stream, despite the assumption

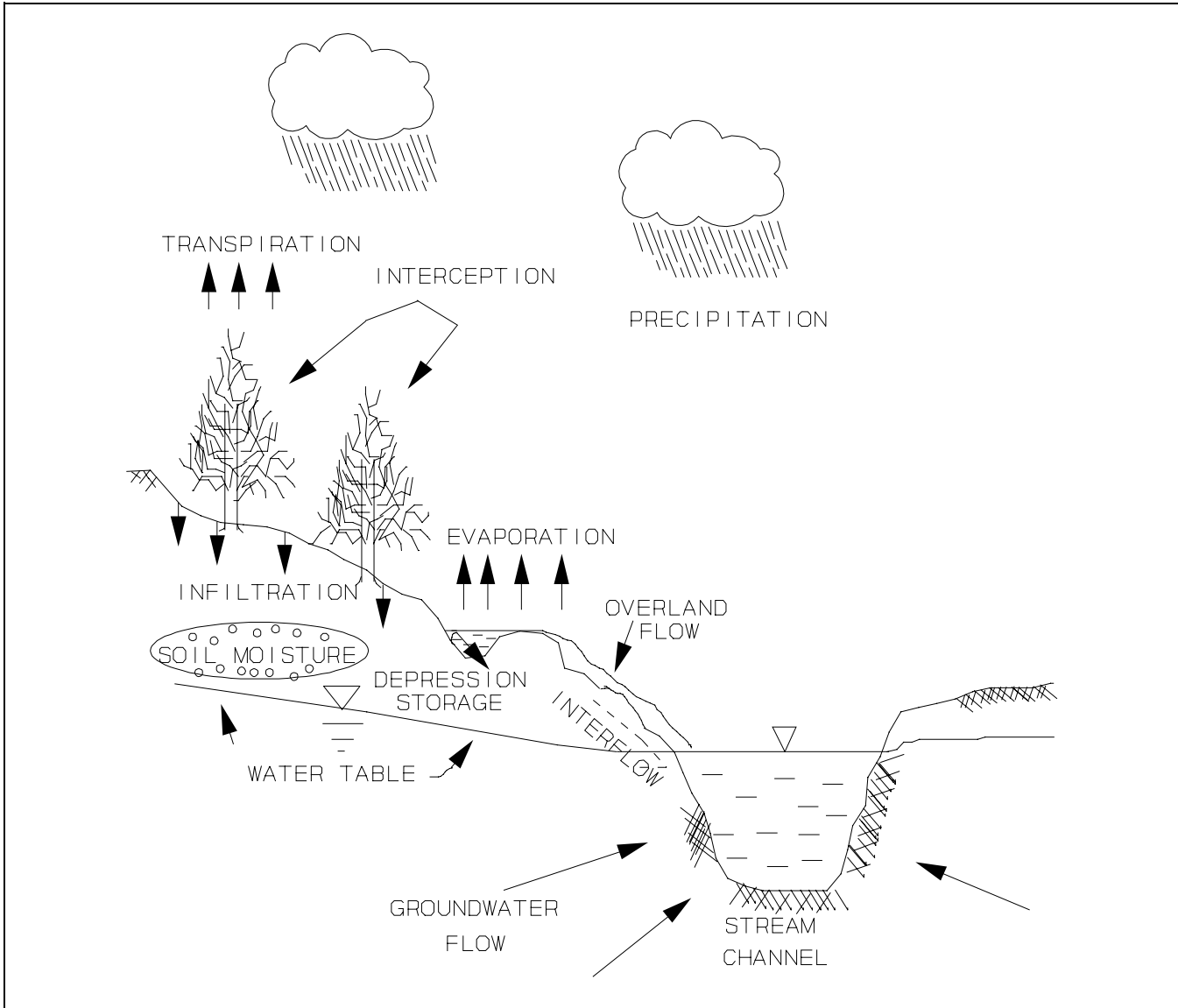

Figure 8-1. The hydrologic cycle

of horizontal flow. However, the equation does not preserve the description of the phreatic surface of the aquifer.

(4) Linearization of the Boussinesq equation for one-dimensional (1-D) flow results in the following differential equation for aquifer discharge (Figure 8-2):

$$T \frac{\partial^2 h}{\partial x^2} = S \frac{\partial h}{\partial t} \quad (8-1)$$

where

T = average aquifer transmissivity

h = phreatic surface or water table height from an arbitrary datum in the aquifer as a function of position x

S = aquifer storativity

t = time

Solution of this equation for the recession portion of the base flow or hydrograph or equivalently for a falling phreatic surface in an aquifer is of the form:

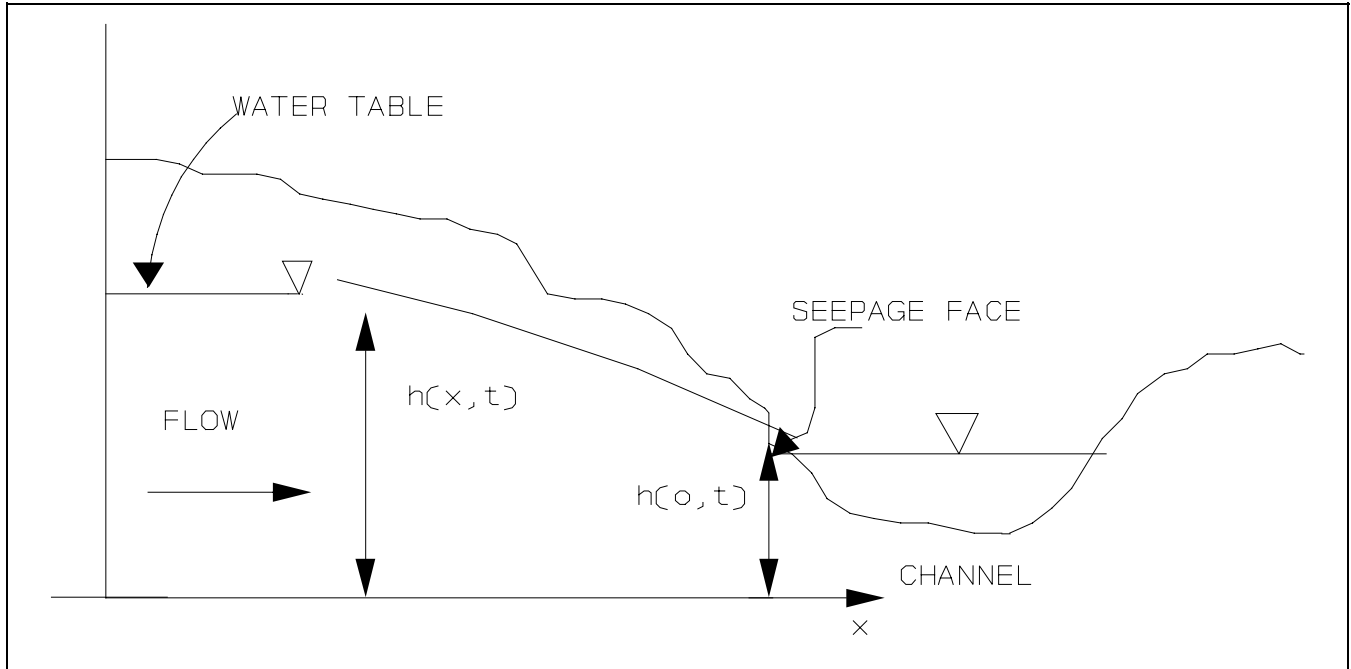

Figure 8-2. Simple groundwater model for recession analysis

$$h(0,t) \sim Ce^{-\alpha t} \quad (8-2)$$

where

$h(0,t)$ = height of the aquifer phreatic surface at the stream interface

C = constant depending on x , aquifer geometry and initial position of the phreatic surface

$$\alpha = (T/S)$$

Since the groundwater discharge is proportional to the slope of the phreatic surface given the Dupuit-Forcheimer assumptions, the aquifer discharge or base-flow recession will also decay exponentially. Note that the decrease in flow with time or the recession is proportional to an exponential decay.

(5) The expected exponential decay in discharge is used to identify the point at which the base-flow recession begins. The standard technique is to plot $\log Q$ versus time and to determine the point at which the recession becomes a straight line.

b. Application of base-flow separation techniques. Base-flow recession analysis characterizes only the

recession limb of the base-flow hydrograph (Figure 8-3). Techniques for determining the rising limb of the base-flow hydrograph vary widely. Viessman et al. (1977) describes various approaches to this problem. As an example, the approach used in the HEC-1 watershed model (USACE 1990a) will be discussed in this section.

(1) The HEC-1 model provides means to include the effects of base flow on the streamflow hydrograph as a function of three input parameters, STRTQ, QRCSN, and RTIOR. The variable STRTQ represents the initial flow in the river. It is affected by the long-term contribution of groundwater releases in the absence of precipitation and is a function of antecedent conditions (e.g., the time between the storm being modeled and the last occurrence of precipitation). The variable QRCSN indicates the flow at which an exponential recession begins on the receding limb of the computed hydrograph. Recession of the starting flow and "falling limb" follow a user specified exponential decay rate, RTIOR, which is assumed to be a characteristic of the basin. RTIOR is equal to the ratio of recession limb flow to the recession limb flow occurring 1 hr later. The program computes the recession flow Q as:

$$Q = Q_0(RTIOR)^{-n\Delta t} \quad (8-3)$$

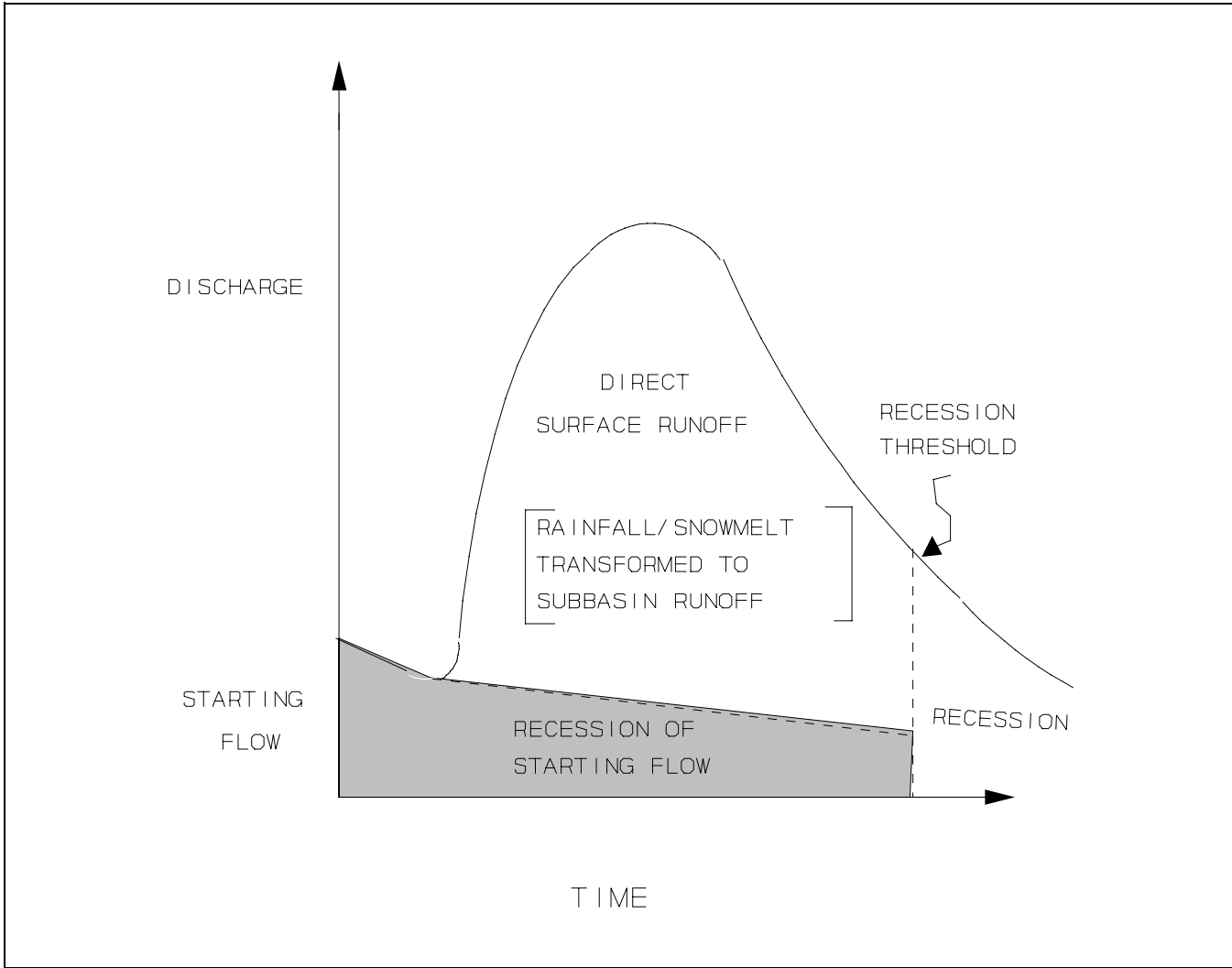

Figure 8-3. Base-flow separation diagram

where

$$Q_o = \text{STRTQ or QRCSN}$$

$$n\Delta t = \text{time in hours since recession was initiated}$$

QRCSN and RTIOR can be obtained by plotting the log of observed flows versus time. The point at which the recession limb fits a straight line defines QRCSN and the slope of the straight line is used to define RTIOR. Alternatively, QRCSN can be specified as a ratio of the peak flow. For example, the user can specify that the exponential recession is to begin when the "falling limb" discharge drops to 0.1 of the calculated peak discharge.

(2) The rising limb of the streamflow hydrograph is adjusted for base flow by adding the recessed starting

flow to the computed direct runoff flows. The falling limb is determined in the same manner until the computed flow is determined to be less than QRCSN. At this point, the time at which the value of QRCSN is reached is estimated from the computed hydrograph. From this time on, the streamflow hydrograph is computed using the recession equation unless the computed flow rises above the base-flow recession. This is the case of a double-peaked streamflow hydrograph where a rising limb of the second peak is computed by combining the starting flow recessed from the beginning of the simulation and the direct runoff.

(3) The values for these parameters can be established by regionalizing results from gauged basins. As an example, consider the attempts to determine base-flow

parameters for the Upper Hudson and Mohawk Rivers in New York.

(4) The starting flow, $STRTQ$, can be determined by plotting the initial streamflow observed prior to events versus drainage area (Figure 8-4). The recession-flow parameters were determined for each event by means of plotting the recession discharge versus time on semilog paper (Figure 8-5). $QRCSN$ is the value of the discharge where the recession begins to plot as a straight line and $RTIOR$ is related to the slope of this straight line. Figure 8-5 is not representative of all efforts to determine the recession parameters. In a significant number of instances, a straight line was not easily detectable on the semilog plot. Note that this study was performed with an older version of HEC-1 where $RTIOR$ is defined as the ratio of the flow to that observed 10 time periods later rather than 1 time period later as defined in the current model.

(5) The results of the analysis indicated that $RTIOR$ varied between 1.1 and 1.7 for the gauges and events examined. Since this range of values does not have a large affect on the recession limb, an average value of 1.3 was assumed for all subbasins. As in the case of $STRTQ$, $QRCSN$ was graphically related to drainage area as shown in Figure 8-6.

8-3. Evapotranspiration

a. Introduction. The fundamental water balance relationship that a continuous simulation model must satisfy to accurately represent the hydrologic cycle is:

$$\text{runoff} = \text{precipitation} - \text{evapotranspiration}$$

Consequently, estimating ET is of major importance. This section is dedicated to describing the theory and application equations used to estimate ET in continuous simulation models.

b. Basis for computation of evapotranspiration. As in the case of infiltration, a well developed evapotranspiration (ET) theory exists for ideal conditions, i.e., conditions where the properties of the soil and the vegetative cover are well defined. However, the theory, as in the case of infiltration, is rarely implemented in a watershed model because the actual field situation deviates significantly from the ideal conditions assumed in the theory. Instead, the theory is used as a basis to develop many parametric methods that attempt to capture the essence of the evapotranspiration process.

(1) The following development is for calculating *potential* evapotranspiration (PET). PET is an estimate of the maximum amount of ET that may occur given available water. For an open water body, PET and ET are equivalent since the water supply is not limiting. Water supply is limiting in applications to bare ground or vegetative cover because available soil moisture, conductivity of the soil profile, and/or plant resistance may be limiting. Consequently, PET and ET are not equivalent in soil moisture accounting algorithms.

(2) The various parametric equations used to calculate PET have similarities that can be recognized from a rudimentary understanding of evapotranspiration theory. Consequently, the purpose of this section is to describe evapotranspiration theory so that the relationship between the parametric methods used can be related via an overall knowledge of the factors that affect ET.

(3) Evaporation theory is most easily developed by considering evaporation from a water surface and then extending these concepts to plant transpiration and evaporation from bare surfaces. Diffusion and energy budget methods have both been used to compute evaporation from a water surface. The diffusion method examines the transfer of water between water and gaseous states. Water, in a closed system, will evaporate from the water surface until the water vapor pressure above the surface reaches the saturation value. At this point, an equilibrium exists between liquid and gaseous phases of water.

(4) Practically speaking, equilibrium is not attained in the field because the atmosphere is unbounded and wind plays a major role in convecting moist air away from the water surface. The diffusion approach models this situation by assuming that a thin film of saturated air above the water surface is evaporated by convection from the wind. The rate at which wind convects water vapor from the water surface (the evaporation rate) is determined based on thermodynamic and aerodynamic principles to be proportional to:

$$E = bu(e_s - e) \tag{8-4}$$

where

E = evaporation rate

b = proportionality constant

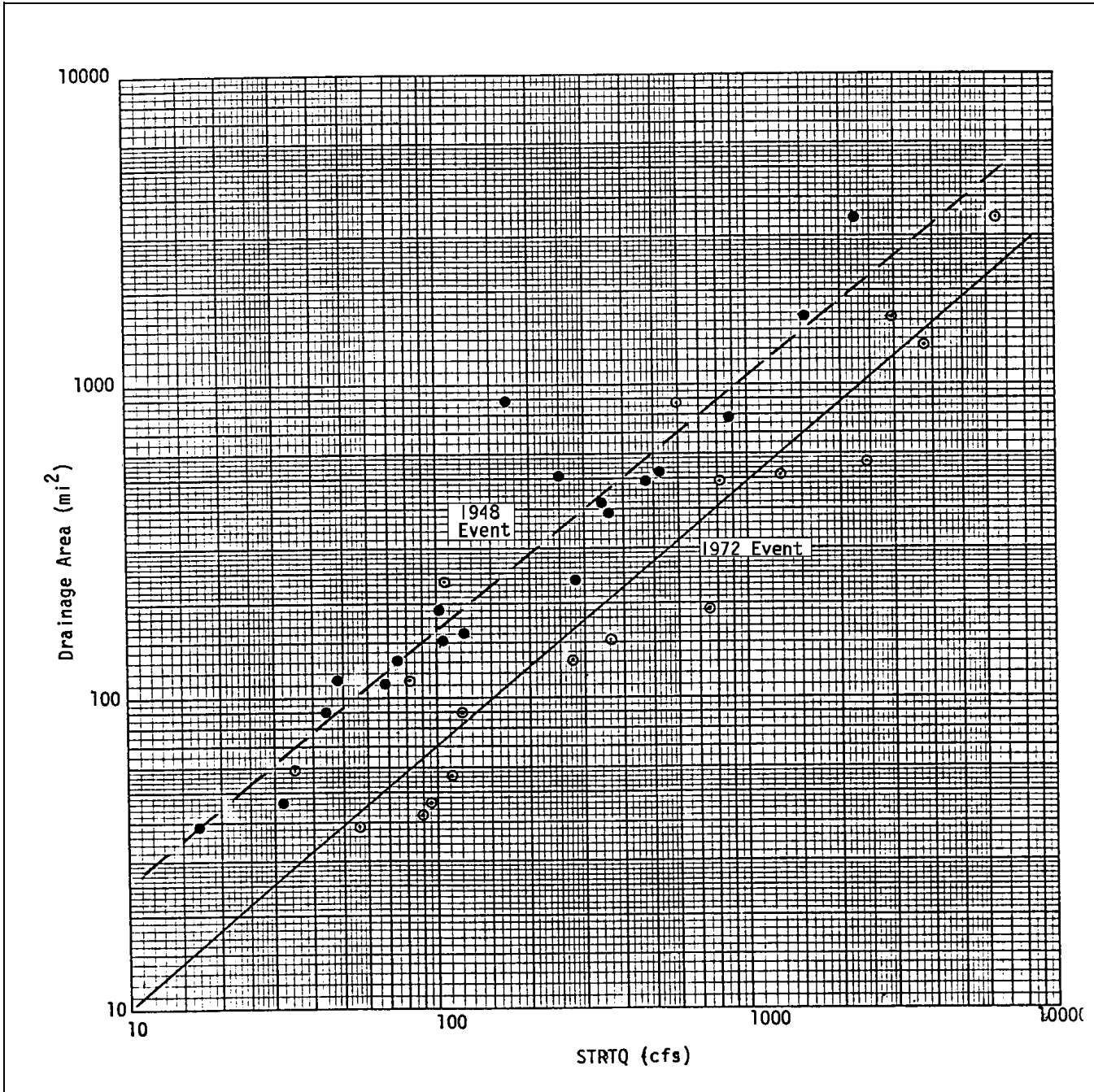

Figure 8-4. Initial flow versus drainage area Mohawk and Upper Hudson River

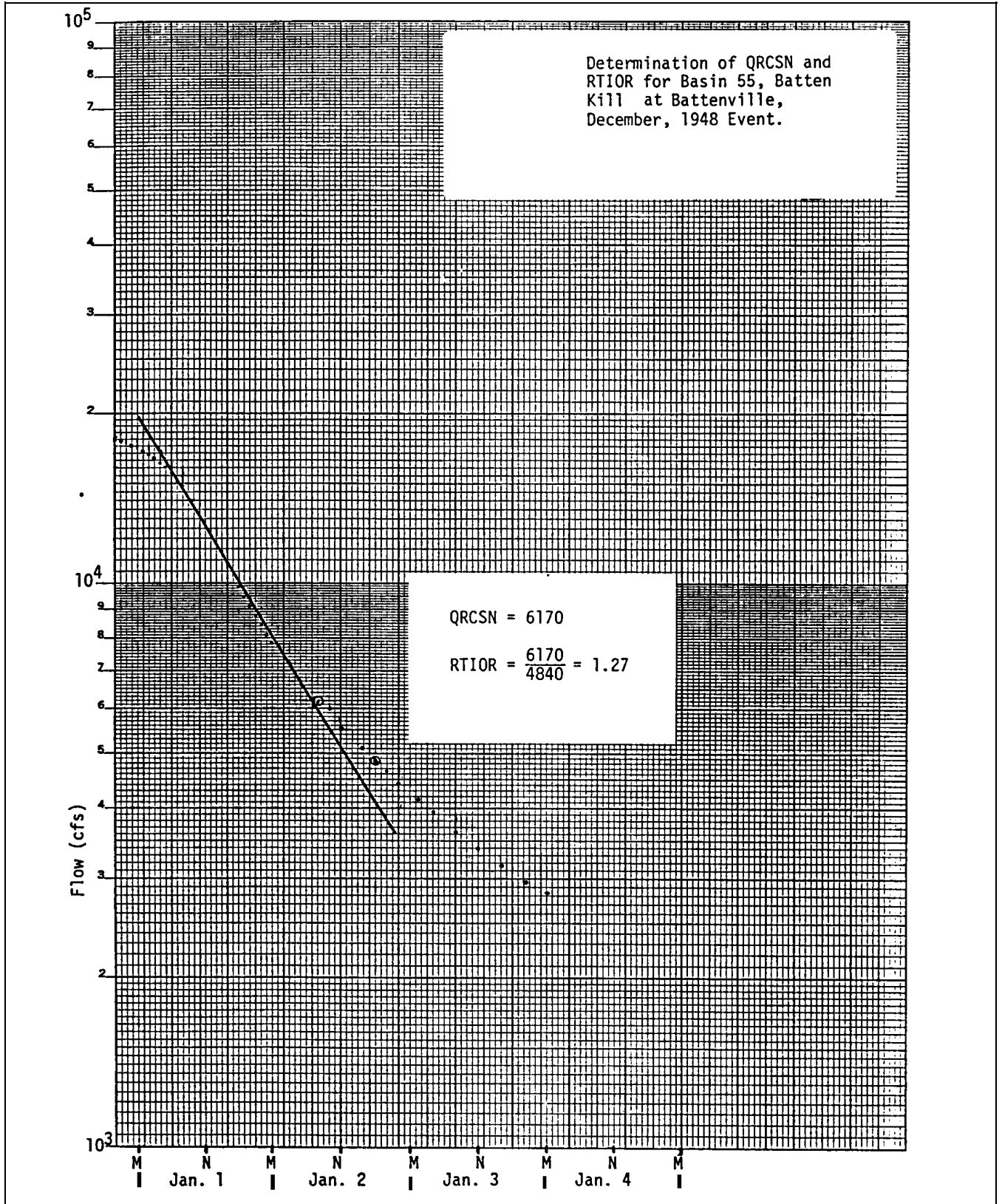

Figure 8-5. Determination of QRCSN and RTIOR for Basin 55, Batten Kill at Battenville, NY, December, 1948 Event

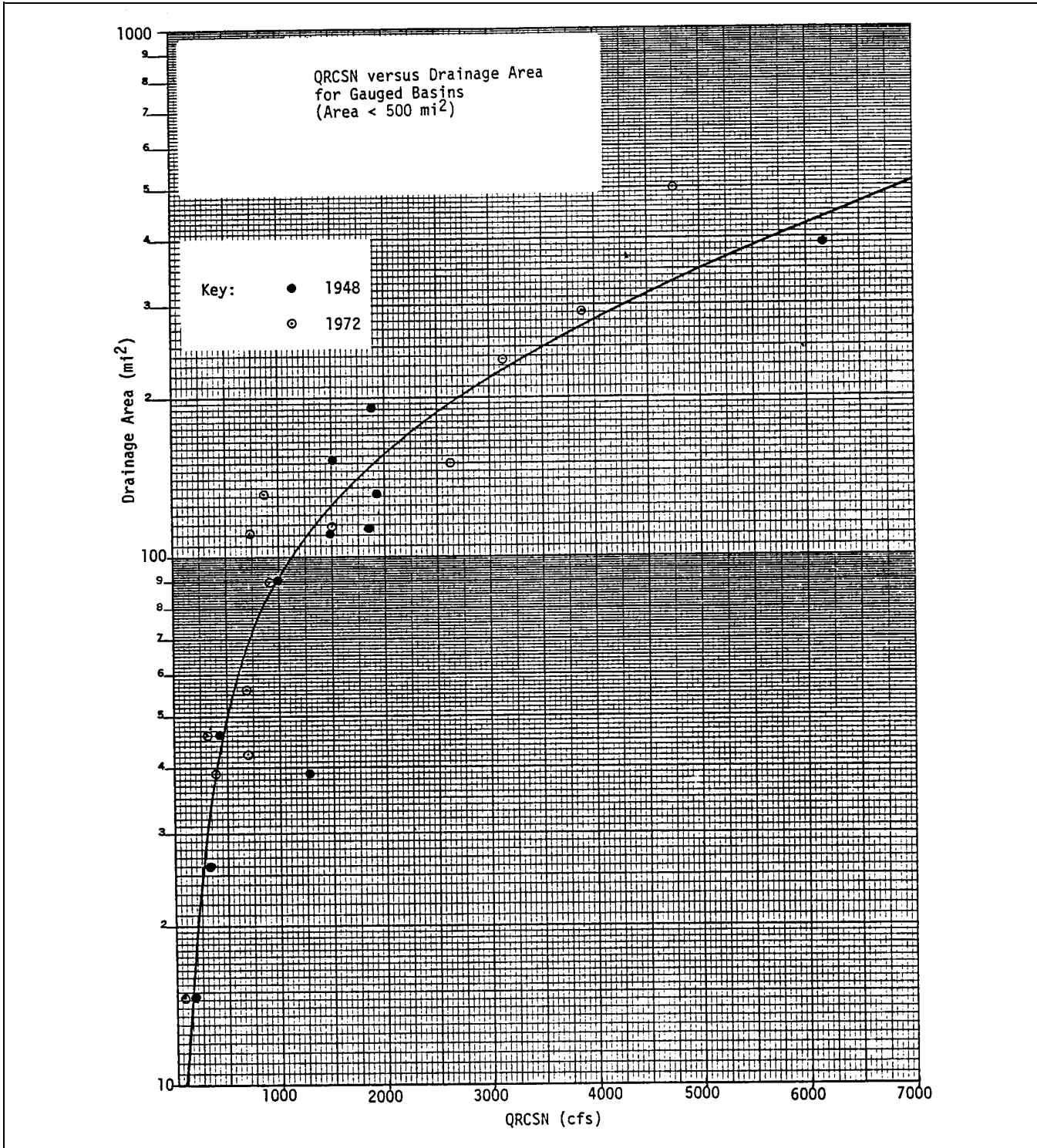

Figure 8-6. QRCSN versus drainage area for gauged basins, Upper Hudson and Mohawk Basin

e_s = water saturation vaporization pressure

e = vapor pressure at the elevation at which u , the wind speed is measured

The diffusion approach is not general because evaporation occurs in the absence of wind. Consequently, the method is modified to account for this possibility by adding a constant so that the evaporation rate is determined by:

$$E = (a + bu)(e_s - e) \quad (8-5)$$

where a and b are determined empirically from field data.

(5) An alternative approach to computing evaporation is the energy budget approach which computes the rate of increase of energy storage within the body, Q_s as:

$$Q_s = Q_i + Q_a - Q_r - Q_b - Q_e - Q_h \quad (8-6)$$

where the sources and sinks of heat are due to Q_i the incoming shortwave radiation from the sun, Q_a is the sum of all other sources of heat (due to seepage, rainfall, or other water inflows), Q_r reflected shortwave solar radiation, Q_b outgoing long wave radiation due to the "black body affects," and Q_e is the energy utilized in evaporation (latent heat), and Q_h is the conducted and convected heat. This expression can be used to calculate evaporation rate by utilizing the Bowen ratio:

$$R = \frac{Q_h}{Q_e} \quad (8-7)$$

and relating the energy used in evaporation to the evaporation rate as:

$$Q_e = \rho_e L_e E A_s \quad (8-8)$$

where

ρ_e = density of evaporated water

L_e = the latent heat of vaporization

A_s = surface area of the water body

Substituting Equations 8-7 and 8-8 into Equation 8-6, the evaporation rate is computed as:

$$E = \frac{(Q_i - Q_r) - Q_b + (Q_a - Q_s)}{\rho_e L_e A_s (1 + R)} \quad (8-9)$$

Application of this equation requires that some measurement of incoming solar radiation is available to estimate Q_i and Q_r ; and the temperature of the water body and all other inflows of water be known so that the other heat terms can be computed.

(6) Penman (1948) combined the best features of both the diffusion and energy budget methods to obtain an expression similar to Equation 8-5, except that the coefficients a and b are calculable if data are available on temperature of the water body and net incoming solar radiation.

(7) Modification of methods for calculating evaporation from water surfaces to vegetative surface requires the concept of potential evapotranspiration. Unlike water bodies, water contents available in the soil via plants or bare surfaces may not be sufficient to support the capacity of the atmosphere to retain water. In this case, methods have been developed to compute the potential evapotranspiration, i.e., the evaporation that would occur if there were sufficient moisture.

(8) The Penman method was modified by Monteith (1965) to compute potential evapotranspiration. This required that a concept known as diffusion resistance (a resistance to evaporation) be incorporated into the Penman equation. The resistance to evaporation is divided into components due to atmospheric effects and plant effects. The atmospheric effects are, at least theoretically, calculable from thermodynamic and aerodynamic principles. However, the plant effects due to the resistance to moisture flux through plant leaves and the soil must be determined empirically.

(9) In summary, the calculation of potential evapotranspiration is based on the theory of evaporation from water surfaces. A significant amount of data on wind speed, net influx of solar radiation, temperature, and empirical information is needed for this calculation.

c. *Empirical approaches to calculation potential evapotranspiration.* Numerous empirical approaches for calculating PET exist. Most basic texts on hydrology summarize available methods (e.g., Viessman et al. 1977). The difficulty with most of these methods (and with calculations of ET in general) is that their basis is for open water bodies rather than land surfaces with vegetative cover.

(1) In this section, the empirical methods used by several continuous simulation models (PRMS, USGS 1983 and SSARR, USACE 1987) are described. PRMS allows the option of using pan evaporation, temperature, or energy-budget methods. The pan evaporation method, probably the most common and popular method for calculating PET, is estimated as:

$$PET = EPAN (EVC (MO)) \quad (8-10)$$

where

EPAN = daily evaporation loss

EVC = empirical pan coefficient, less than 1.0, that varies monthly

The pan coefficient is intended to account for the differences between the thermodynamics of the pan and the prototype (e.g., a reservoir or catchment).

The temperature method by Hamon (1961) calculates PET as:

$$PET = CTS(MO) (DYL^2) (VDSAT) \quad (8-11)$$

where

CTS = empirical coefficient that varies monthly

DYL = possible hours of sunshine in units of 12 hours

VDSAT = saturated water vapor density at the daily mean temperature in grams per cubic meter

PET = inches per day

VDSAT is computed as (Federer and Lash 1978):

$$VDSAT = 216.7 \frac{VPSAT}{(TAVC + 273.3)} \quad (8-12)$$

where

TAVC = mean daily temperature, in degrees Celsius

VPSAT = saturated vapor pressure in millibars at *TAVC*

VPSAT is calculated as:

$$VPSAT = 6.108 \left[\exp \left(17.26939 \frac{TAVC}{(TAVC + 273.3)} \right) \right] \quad (8-13)$$

The energy budget approach by Jensen and Haise (1963) calculates *PET* by:

$$PET = CTS(MO) (TAVF - CTX) (RIN) \quad (8-14)$$

where

CTS = coefficient that varies monthly

TAVF = mean daily temperature, in degrees Fahrenheit

RIN = daily solar radiation, in inches of evaporation

PET = inches per day

CTX = coefficient that is a function of humidity and watershed elevation

CTS is calculated as:

$$CTS = [C1 + 13.0(CH)]^{-1} \quad (8-15)$$

where

CI = elevation correction factor

CH = humidity index

CI is calculated as:

$$CI = 68.0 - \left[3.6 \left(\frac{EI}{1000} \right) \right] \quad (8-16)$$

where EI = median elevation of the watershed, in feet msl. CH is calculated as:

$$CH = \frac{50}{(e_2 - e_1)} \quad (8-17)$$

where e_2 and e_1 = saturation vapor pressure (mb) for respectively the mean maximum and minimum air temperatures for the warmest month of the year. CTX in Equation 8-14 is computed as:

$$CTX = 27.5 - 0.25(e_2 - e_1) - \left(\frac{E2}{1000} \right) \quad (8-18)$$

where $E2$ = mean elevation for a particular subbasin.

(2) The SSARR model provides the capability for the user to supply PET values or calculate a basic PET via the Thornthwaite (1954) method:

$$PET = 1.6b(10T/I)^a \quad (8-19)$$

where

T = mean monthly temperature

b = factor to correct for the difference in days between months

I = annual heat index

a = cubic function of I

PET = monthly value

I is the sum of the monthly heat indices:

$$I = (T/5)^{1.514} \quad (8-20)$$

SSARR converts the PET to a daily value and then provides the capability to adjust this value for snow covered ground, month of the year, elevation of a particular snow band, and for rainfall intensity (i.e., PET is reduced when it is raining).

(3) In summary, empirical PET methods may be based on pan evaporation, mean monthly temperature, or energy budget equations. The pan evaporation approach is probably most popular and is certainly simplest. A further discussion of the importance of ET estimation and the corresponding choice of method will be given in paragraph 8-6 on parameter estimation.

8-4. Continuous Simulation Approach to Subsurface Modeling

a. Fundamental processes. Continuous simulation models attempt to conceptually represent the subsurface dynamics of water flow. The subsurface flow dynamics can be separated into wetting and drying phases. In the wetting phase, a wetting front of infiltrated water heads downward toward the groundwater aquifer as rainfall or snowmelt falls on the watershed surface. The aquifers of interest in this case are termed phreatic in that the aquifer surface is defined by water at atmospheric pressure. In response to this influx of infiltrated water, the groundwater levels may rise, if the influx is great enough, and the rate of water discharging from the aquifer to the stream increases. Streamflow due to aquifer discharge is usually termed base flow. The aquifer may also discharge to deep percolation depending on the permeability of soils or bedrock underlying the aquifer.

(1) For the infiltration phase of this process, in Chapter 6, the Richards equation describes an infinitely deep soil profile on infiltration. The consideration of infiltration in this instance is complicated because of the transition between unsaturated flow in the finite thickness soil profile and the saturated aquifer flow.

(2) The dynamics of the drying phase are not symmetrical with that of the wetting phase because of the affects of evapotranspiration and soil hysteresis. Soil hysteresis occurs because the unsaturated hydraulic conductivity is not a unique function of water content. The usual explanation for this curious behavior is that soil

pores do not fill and drain in the same sequence. Evaporation also affects the drying front depending on the vegetative cover and depth of the root zone.

(3) At some point during the drying phase, the aquifer levels must decrease, and the base-flow discharge must also decrease. This decrease in flow, at least theoretically, can be identified by an exponential decay.

(4) The generally accepted method for calculating the flow in this system is to simultaneously solve Richards' equation and Darcy's Law for a phreatic aquifer. However, this is a rather numerically intense exercise and is rarely performed as part of a watershed analysis.

(5) As described in Chapter 6, the overall dynamics of the direct runoff process is rather complicated by a number of factors. An additional complicating factor that had not been mentioned previously is the heterogeneity of the groundwater aquifer. These heterogeneities make it difficult to identify the characteristics of the aquifer response, particularly the identification of the exponential decay of the base flow.

(6) In summary, the dynamics of the subsurface process are complex even for an ideal soil profile and aquifer. The dynamics may be modeled using a combination of Richards' equation and Darcy's Law. Practically speaking, this is rarely done in watershed modeling. The use of these methods becomes more difficult and impractical when subsurface heterogeneities are considered.

b. Conceptual models of subsurface flow. There are a multitude of conceptual models that are available to perform continuous moisture accounting. All of these models try to capture the dynamics of subsurface flow with simple storage elements. As a precursor to discussing any of these models, a useful introduction is to construct a generic model that demonstrates the conceptual nature of the soil-moisture accounting model. Consider a model that has only rainfall as an input (Figure 8-7). To begin with, the storages represent surface effects, unsaturated zone, and saturated zone or aquifer storages (all storage shown considers volume in terms of basin-depth, e.g., basin-inches). Consider each zone separately:

(1) Surface storage. The surface storage stores water up to a maximum value of $SMAX$. Water leaves either by evaporation at the potential rate ES , infiltration at a rate equal to FS or via an overflow once $SMAX$ is exceeded. The overflow volume might be routed to the stream via the unit hydrograph method.

(2) Upper zone storage. The upper zone stores water up to a maximum value $UMAX$. Evaporation from the zone at the rate EU models the uptake due to vegetation. Water enters the storage at the rate FS and leaves either by evaporation, infiltration to the lower zone at rate LS , or to the stream via a low-level outlet. If the assumption is made that the upper zone is a linear storage, then the outflow rate is linearly proportional to the storage.

(3) Lower zone storage. The lower zone stores water up to a maximum value $LMAX$. Water enters the storage from the upper zone at the rate LS and leaves via a low-level outlet as in the upper zone case or out of the system at a deep percolation rate, FD . The computation of the outflow rates is based on the following functions:

- Potential evaporation: Compute as a coefficient times the pan evaporation amount.
- Potential infiltration: The infiltration from one zone to another is based on linearly varying function of the storage receiving flow:

$$FP = FMAX \left(1 - \frac{V}{VMAX} \right) \quad VS \leq VMAX \quad (8-21)$$

where $FMAX$ is the maximum infiltration rate into a storage with capacity $VMAX$ and current storage V .

- Low-level outlet: the subsurface storages will be considered linear reservoirs where the outlet discharge is computed as:

$$O = \frac{V}{K} \quad (8-22)$$

where

O = outflow

K = linear reservoir storage coefficient

Application of this model to soil moisture accounting and runoff prediction might be done based on the following outflow rule: evaporation takes precedence over infiltration which in turn takes precedence over outflow from a low-level outlet.

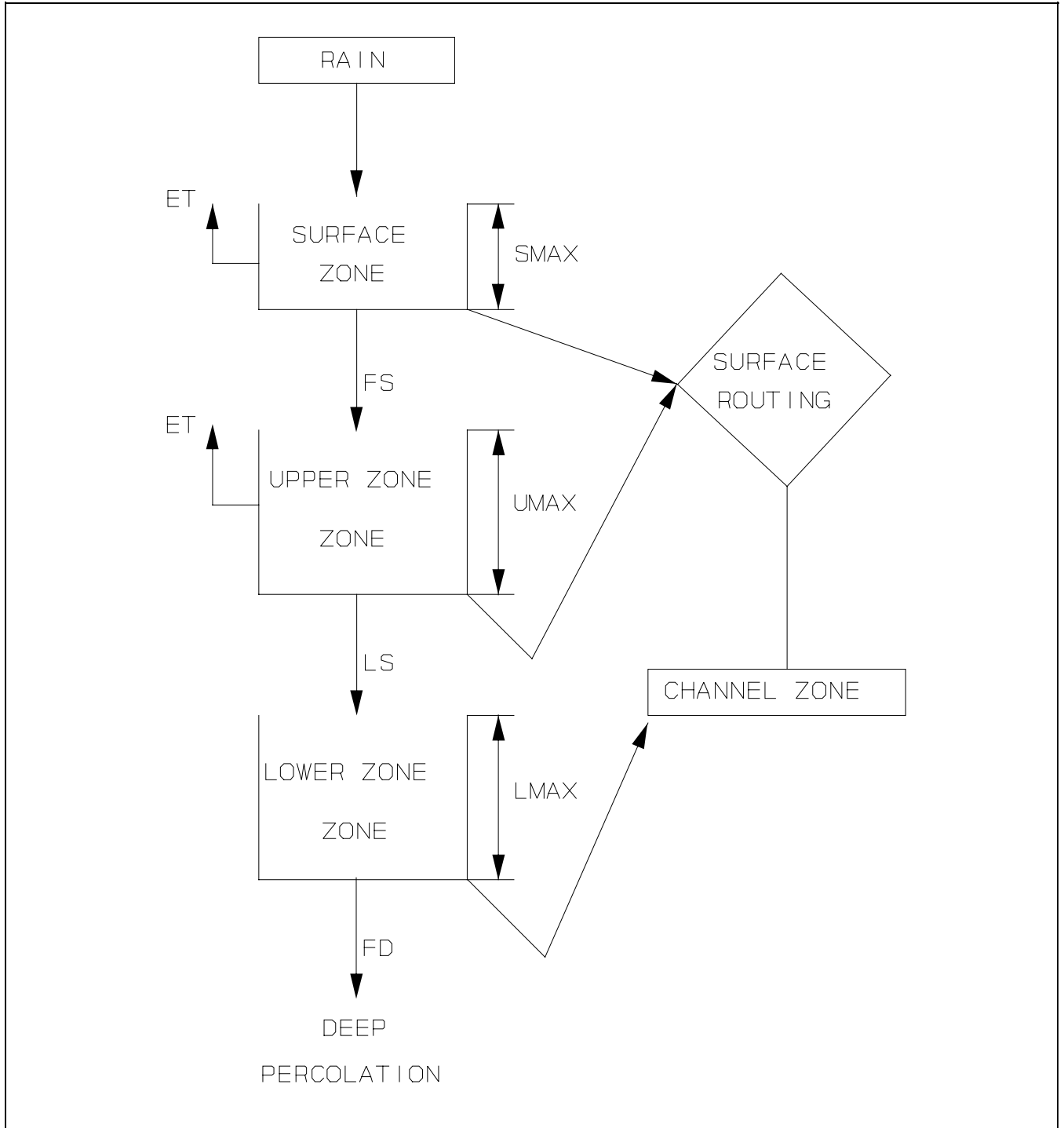

Figure 8-7. Simple example continuous simulation model

(4) Explicit solution algorithm. An explicit solution algorithm would proceed as follows given this rule for the period of duration Δt , or equivalently, between times t_i and t_{i+1} :

(a) Surface zone. Compute the available surface supply VS as:

$$VS = SZ_i + R \quad (8-23)$$

where

SZ_i = storage at the beginning of the period

R = rainfall volume during the period

The volume left in storage after evaporation, VSE , is computed as:

$$VSE = VS - ESP \quad VS \geq ESP \quad (8-24)$$

or:

$$VSE = 0 \quad VS < ESP \quad (8-25)$$

where the evaporated volume ES is lost up to the potential amount ESP if the surface storage is available. The computation of storage, VSF , after infiltration from the surface zone to the upper zone is computed in a similar manner to that of evaporation:

$$VSF = VSE - FUP \quad VSE \geq FUP \quad (8-26)$$

$$FU = FVP \quad (8-27)$$

or:

$$FU = VSE \quad VSE < FUP \quad (8-28)$$

$$VSF = 0 \quad (8-29)$$

where FU is the volume infiltrated to the upper zone up to the potential amount FUP if VSE is large enough.

FUP can be calculated simply from the beginning of period storage in the upper zone, UZ_i . The storage at the end of the period, SZ_{i+1} , is computed as:

$$SZ_{i+1} = VSF \quad VSF < SMAX \quad (8-30)$$

or:

$$SZ_{i+1} = SMAX \quad VSF \geq SMAX \quad (8-31)$$

$$E = VSF - SMAX \quad (8-32)$$

where E is the excess available if the end of period storage exceeds the maximum amount SZM .

(b) Upper zone. The soil moisture accounting for the upper zone proceeds similarly to that of the surface zone except that outflow is routed based on the linear reservoir outflow relationship. The volume available for outflow, VU , is:

$$VU = UZ_i + FU \quad (8-33)$$

where UZ_i is the beginning of period storage. The volume left after evaporation, VUE , is computed as:

$$VUE = VU - EUP \quad VU \geq EUP \quad (8-34)$$

$$EU = VUE \quad (8-35)$$

or:

$$VUE = 0 \quad VU < EUP \quad (8-36)$$

$$EU = VU \quad (8-37)$$

where EU is the volume evaporated up to the potential amount EUP if the storage is available. The volume remaining, VUF , after infiltration from the upper zone to the lower zone is computed as:

$$VUF = VUE - FLP \quad VUE \geq FLP \quad (8-38)$$

$$FL = FLP \quad (8-39)$$

or:

$$VUF = 0 \quad VUE < FLP \quad (8-40)$$

$$FL = VUE \quad (8-41)$$

where FL is the volume infiltrated to the lower zone up to the potential amount FLP if the storage is available. The remaining volume is routed through the linear storage by continuity considerations:

$$OU_i + 1 = \frac{FU - FL - EU + OU_i(Ku + 0.5\Delta t)}{(Ku - 0.5\Delta t)} \quad (8-42)$$

$$UZ_{i-1} = ku(OU_{i-1}) \quad (8-43)$$

where

OU_i and OU_{i+1} = respectively the flows at the beginning and end of the period

UZ_{i+1} = storage at the end of the period

ku = linear reservoir coefficient

(c) Lower zone. The lower zone routing is similar to that of the upper zone except that no evaporation is computed. The volume available for routing through the low level outlet, VL , is simply the increase due to infiltration from the upper zone minus the constant loss due to percolation:

$$VL = LZ_i + FL - FDP \quad (LZ_i + FL) \geq FDP \quad (8-44)$$

$$FD = FDP \quad (8-45)$$

or:

$$FD = LZ_i + FL \quad (FL + LZ_i) < FDP \quad (8-46)$$

$$FD = 0 \quad (8-47)$$

where LZ_i is the storage at the beginning of the period, the loss due to percolation, FD may be a maximum amount up to the potential percolation loss FDP for the period. The outflow from the storage is computed as:

$$OL_i + 1 = \frac{FL - FD - OL_i(Kl + 0.5\Delta t)}{(Kl - 0.5\Delta t)} \quad (8-48)$$

where

OL_i and OL_{i+1} = outflows at the beginning and end of periods, respectively

kl = linear reservoir storage coefficient

(5) Noteworthy aspects. There are two noteworthy aspects of this model. First, the number of parameters needed is significantly larger than needed for an event oriented model:

(a) Evaporation: The adjustment of pan evaporation values will require at least seasonal coefficients which means *four* coefficients that need to be estimated.

(b) Surface zone: Parameters needed are SZM , and unit hydrograph parameters such as Clark, TC, and R, and the surface storage at the beginning of the simulation SZ_0 , total *three* parameters and *one* initial condition.

(c) Upper zone: Parameters needed are UZM , FUM to calculate FUP , KU , and the initial storage UZ_0 , total *three* parameters and *one* initial condition.

(d) Lower zone: Parameters needed are SZM , FLM to calculate FLP , KL , FDP , and the initial storage SZ_0 , total *four* parameters and *one* initial condition.

(6) Parameter estimates. Summing these totals, the number of parameter estimates needed are *fourteen* with *three* initial conditions. This poses a significant

estimation problem for soil moisture accounting models. Furthermore, the generic model formulation ignored the problems of surface interception (water that would be stored but not free for outflow or infiltration), snowmelt and snow excess infiltration, partial area or hillslope effects, and the routing of base flow through more than a linear reservoir. If these processes were included in the model, then there would be a significant increase in the number of parameters that need to be estimated.

(7) Explicit simulation scheme. A second noteworthy aspect of the generic model is the explicit simulation scheme. The explicit simulation scheme can result in a poor simulation if the selected simulation interval, Δt , is not appropriately small. For example, computation of the infiltration loss from one zone to another is dependent on the beginning of period storage. If the storage changes greatly over the computation period, then the infiltration rate computed base on beginning of period storages will be a poor estimate of the average rate that would occur over the period. Consequently, a computation interval that is sufficiently small is needed for accurate numerical simulation with the model.

c. Summary. In summary, the purpose of this section was to introduce the concept of soil moisture accounting via a description of a simple model. Even though the model is simple, the number of parameters that must be estimated easily exceeds the number needed for event oriented estimation. The number of parameters that must be estimated poses some very significant parameter estimation problems.

8-5. Existing Continuous Simulation Models

a. Introduction. There are many different continuous simulation models available which employ different soil moisture accounting algorithms. As examples of soil moisture accounting techniques, two models in the public domain, PRMS (USGS 1983), and SSARR (USACE 1987) will be described.

b. PRMS. The Precipitation-Runoff Modeling System (USGS 1983), PRMS, soil moisture accounting algorithm is summarized in Figure 8-8. The model components represent the following watershed characteristics:

(1) Interception. Interception by vegetation is modeled as a seasonally varying process for a fraction of the basin. The fraction of the basin that has interception loss can be specified for winter and summer via parameter COVDN. The volume of water that can be stored by the

vegetation, *STOR*, varies depending on the type of precipitation: winter snow, winter rain, or summer rain.

(2) Impervious area. This area represents the fraction of the basin that is impervious. Interception does not occur, but a surface loss, *RETIP*, can be specified.

(3) Snow pack. The snow pack is assumed to uniformly cover the entire basin. The assumption is made that it is a two-layer system, the surface layer being 3 to 5 in. thick. Melt water from the pack is proportioned between the pervious and impervious area based on the fraction of the area.

(4) Soil zone reservoir. This reservoir represents the active portion of the soil profile in that soil moisture redistribution is modeled. The capacity of this zone, *SMAX*, is defined as the difference between the field capacity and wilting point (field capacity is a loosely defined concept being generally defined as the water content of the soil after gravity drainage for some extended period from near saturation; the wilting point defines the water content at which plants can no longer extract moisture from the soil). The zone is divided into a recharge zone, capacity *REMAX*, and lower zone with capacity *LZMX* (necessarily the difference between *SMAX* and *REMAX*). The recharge zone must be full before water can move to a lower zone.

(5) Subsurface zone. This zone represents the flow from the soil's unsaturated zone to the stream and ground-water reservoir. The outflow to stream is based on the relationship:

$$\frac{d(RES)}{dt} = (INFLOW) - O_s \quad (8-49)$$

and

$$O_s = RCF(RES) + RCP(RES)^2 \quad (8-50)$$

where

RES = storage in the reservoir

O_s = outflow

RCF and *RCP* = routing parameters

The outflow to the groundwater zone is determined by:

$$O_g = (RSEP) \left(\frac{RES}{RESMX} \right)^{REXP} \quad (8-51)$$

where

O_g = flow to the groundwater zone

$RESMX$, $RSEP$,

and $REXP$ = parameters to be specified

(6) Groundwater zone. This zone represents the storage in a phreatic aquifer and outflow to the stream and deep percolation. Outflow to the stream is based on a linear reservoir assumption, requiring the estimate of a storage coefficient, RCB . Outflow to deep percolation is computed by the product of a coefficient $GSKN$ time the current storage in the zone. Model simulation occurs at a daily computation interval if any snowpack exists or at the minimum of 5 min or a user-specified value if a snow-free ground event is occurring. The procedure for routing precipitation through the system is performed as follows:

(a) Precipitation. The form of the precipitation is determined by either of two methods: a temperature BST is specified that together with maximum and minimum daily air temperatures is used to determine if rain, snow, or a mixture of both is the form of the precipitation; or, alternatively, a temperature PAT is specified that is the threshold for rain to snow formation.

(b) Surface interception. The daily potential evapotranspiration, EPT , is computed based on one of three methods: a pan coefficient method, a method that uses daily mean temperature and daily hours of sunshine, or a method that uses daily mean air temperature and solar radiation (see paragraph 8-3). Interception is computed for the open fraction of the subbasin. The EPT demand fraction for the open portion of the basin is satisfied, if possible, from the interception storage either as evapotranspiration or snow sublimation.

(c) Snowpack growth/melt. Snowpack simulation is performed at a daily time step. The snowpack growth/melt dynamics are based on a complex energy-balance approach. A detailed discussion of this algorithm is beyond the scope of this discussion. However, as described in the previous section on snowmelt, energy budget approaches are rather data intensive.

(d) Runoff available from impervious surface. Runoff from the impervious fraction is computed by consideration of the available excess, surface storage, and EPT . The surface storage is increased by the amount of the snowmelt/rainfall excess and depleted by evapotranspiration up to the maximum amount EPT . The remaining amount in excess of surface storage $RETIP$ becomes runoff excess.

(e) Surface runoff - daily mode. A water balance is performed on the soil zone to determine the fraction of water that contributes to subsurface storages and open-area runoff. Inflow to the soil zone is treated differently for snowpack or bare ground. Snowpack infiltration is unlimited until field capacity is reached in the recharge zone. At field capacity, the infiltration rate is limited to a constant value SRX . Snowmelt excess, including rain on the snowpack, in excess of SRX contributes to surface runoff. Surface runoff due to rain on snow is computed using a contributing area principle as:

$$SRO = CAP(PTN) \quad (8-52)$$

where CAP is used to factor the available rain on snowmelt into surface runoff and infiltrating volumes and PTN is the daily precipitation. CAP may be determined via a linear or nonlinear function of antecedent moisture. The linear function is:

$$CAP = SCN + \left[(SCX - SCN) \left(\frac{RECHR}{REMX} \right) \right] \quad (8-53)$$

where

SCN and SCX = minimum and maximum contributing watershed area, respectively

$RECHR$ and $REMX$ = storage parameters defined previously for the soil moisture zone

The nonlinear function is:

$$CAP = SCN(10^{(SC1(SMDX))}) \quad (8-54)$$

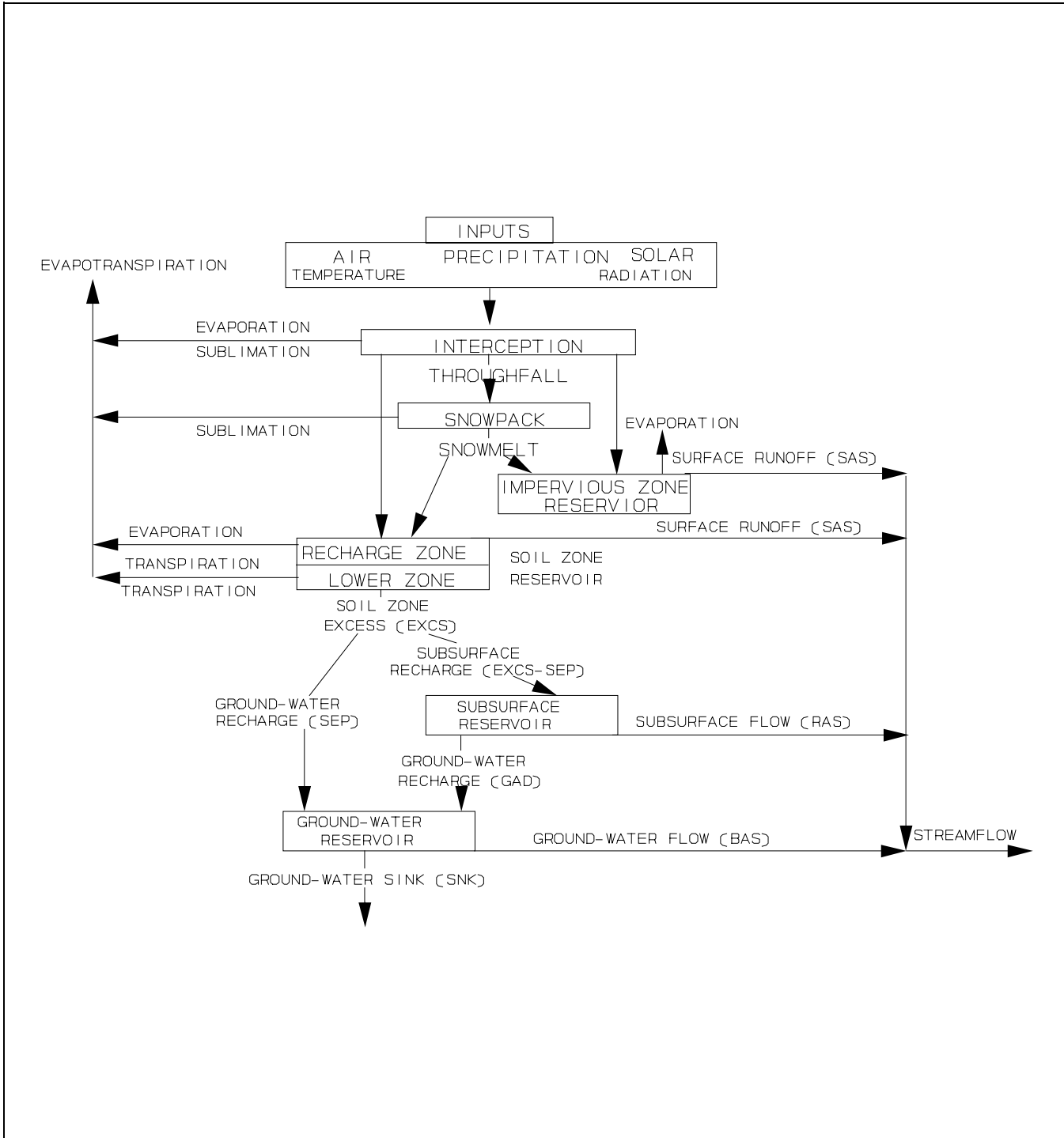

Figure 8-8. PRMS, schematic diagram of the conceptual watershed system and its inputs

where

SCN and $SC1$ = coefficients to be determined

$SMIDX$ = sum of the current available water in the soil zone (SMAV) plus one-half PTN

The coefficients of this method might be determined from soil moisture data, if available. If data are not available, then the user's manual suggests determining the coefficients from preliminary model runs. An example of the determining the coefficients for the nonlinear method as a function of an antecedent precipitation index is given in Figure 8-9. (The description in the users manual (USGS 1983) of how to establish this relationship from a preliminary model is not detailed and would seem to be very difficult).

(f) Surface runoff - event mode. Rainfall infiltration on snow-free ground is calculated from a potential infiltration rate adjusted for spatial differences in infiltration potential. The potential infiltration rate is based on a modified version of the Green and Ampt equation (Chapter 6). The modification involves multiplying the soil moisture deficit at field capacity by the product of the fraction of the storage available in the recharge zone and a user defined coefficient. The infiltration rate necessarily becomes zero when the recharge zone reaches maximum capacity. The spatial variation in infiltration properties is then accounted for as shown in Figure 8-10. Rainfall not infiltrated is then routed overland to the stream by the kinematic wave method. Infiltrated rainfall moves to the soil profile zone. Stored water is first lost to EPT that is not satisfied by surface interception from the recharge zone and then from the lower zone. In addition, water is lost from the lower zone to the groundwater zone up to a maximum rate SEP; and volume available in excess of this rate moves to the subsurface zone. Inflow from the soil zone to the groundwater and subsurface zones is routed to the stream by the equations described previously.

c. *SSARR*. The Streamflow Synthesis and Reservoir Regulation model (*SSARR*) performs continuous simulation of watershed runoff and reservoir operations. Watershed runoff simulation may be performed with either the "depletion curve" or the more general "snow band model." The more general snow band model will be discussed.

(1) Model simulation. Model simulations are performed at a user specified computation interval. Basin temperature and precipitation are input to the model as

conceptualized in Figure 8-11. The model accumulates snow in different user defined elevation bands (thus the term snow-band model). The amount of snow accumulated depends on the elevation band temperature which is a function of the input temperature and elevation-temperature lapse rate. The soil moisture accounting aspect of the runoff algorithm is performed for each band. The accumulated runoff from the bands is then routed through conceptual storages to the outlet of the watershed.

(2) Differences. The model differs from PRMS, and most other conceptual continuous simulation models, in that the soil moisture accounting is **not** envisioned as an interconnected group of conceptual storages. Rather, the precipitation is routed through the system based on a set of empirical relationships, until the final routing to the basin outlet. The individual relationships are as follows:

(a) Interception. Interception is specified as total basin volume. Precipitation in excess of this amount reaches the ground surface. The intercepted volume is decreased to the potential evapotranspiration.

(b) Snowpack. The snowpack is assumed to be distributed uniformly over the watershed fraction represented by a particular elevation band.

(c) Soil moisture input zone. The soil moisture input zone accounts for the water balance in the water profile. This zone receives moisture input either from snowmelt or rainfall on bare ground. The amount of direct runoff, evapotranspiration, and percolation to the lower zone depends on an empirical index of the water content of this zone. The index ranges from a small percent representing the wilting point, to a value approaching 100 percent representing field capacity. At the wilting point there will be very little direct runoff, conversely, at field capacity, the direct runoff would approach 100 percent of available moisture. The soil moisture index varies based on the following relationship:

$$SMI_2 = SMI_1 + (MI - RGP) - \frac{PH(ETI)}{24} \quad (8-55)$$

where

SMI_1 and SMI_2 = the soil moisture indexes at the beginning and end of a compute period, respectively

PH = compute period length, in hours

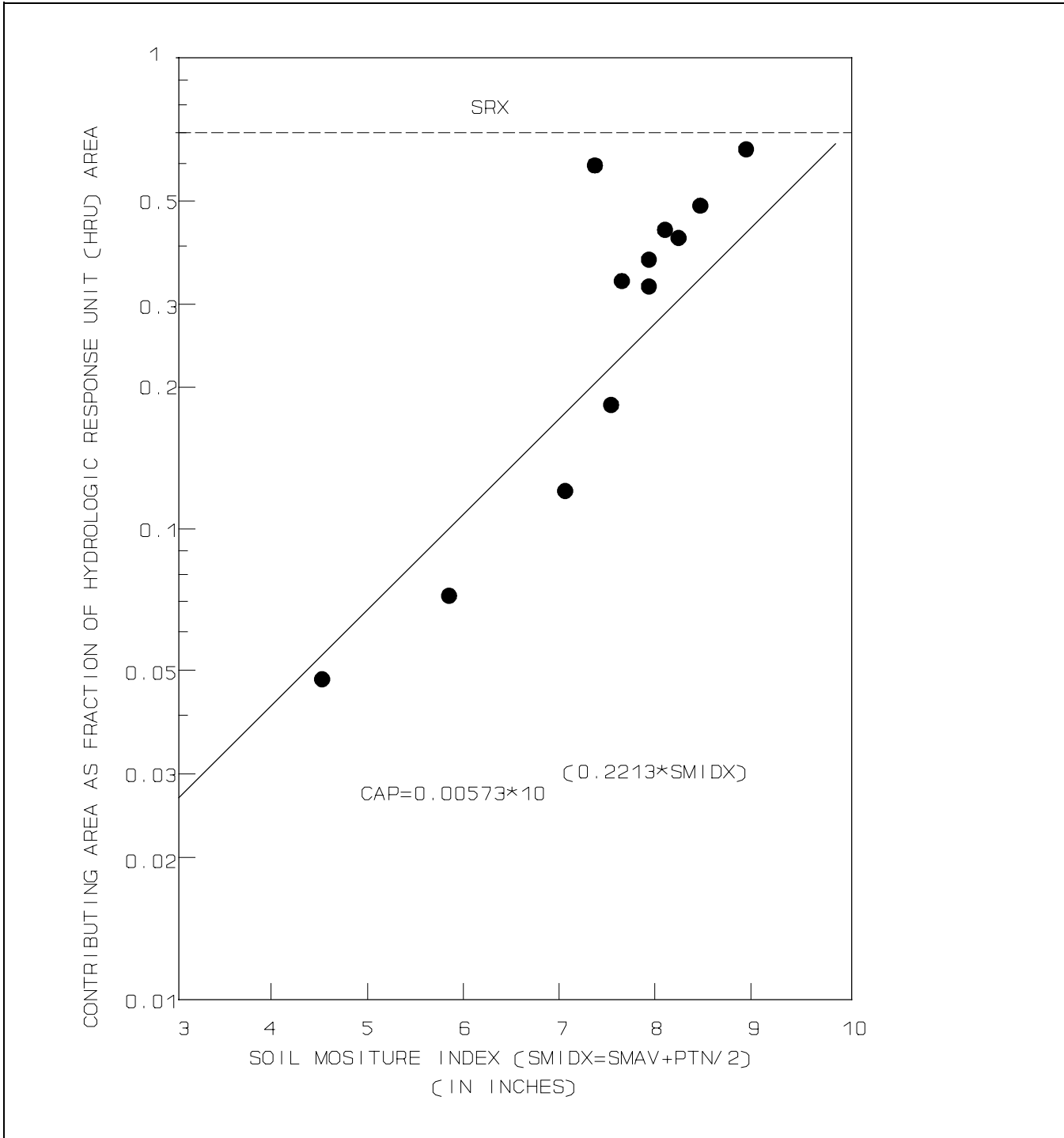

Figure 8-9. Sample PRMS partial area corrections. The relation between contributing area (CAP) and soil-moisture index (SMIDX) for Blue Creek, AL

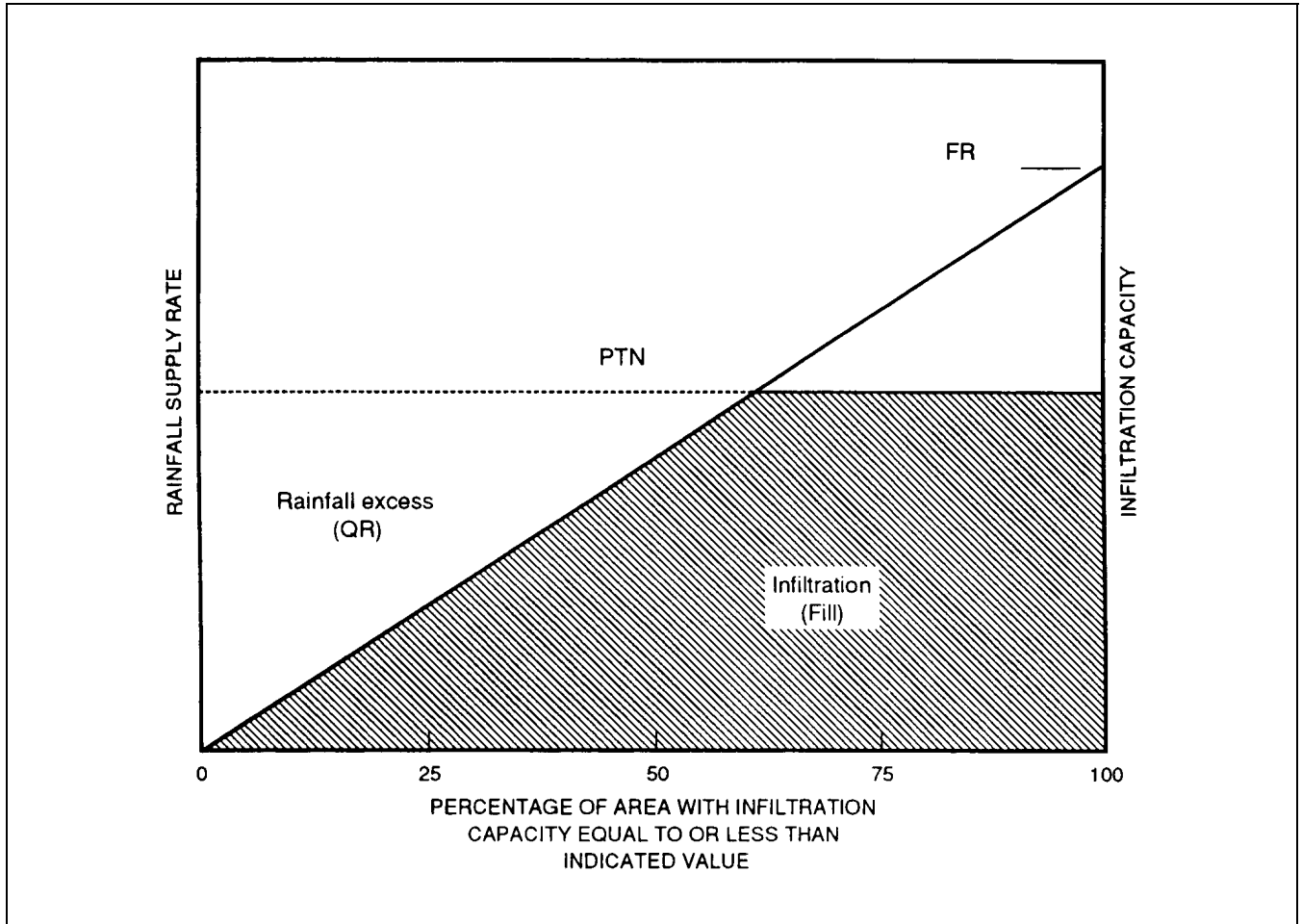

Figure 8-10. PRMS function which determines fraction of area contribution runoff due to variation in infiltration capacity

MI = available excess from snowmelt and rainfall

ETI = evapotranspiration index, in inches per day

PH = computation interval, in fractions of a day

RGP = computed surface runoff

A user estimated empirical relationship is used to calculate surface runoff from the soil moisture index. This empirical relationship may consider the intensity of the available moisture input to the zone (e.g., Figures 8-12 and 8-13). The rate of supply available for outflow is computed as:

$$RGP = ROP(MI) \quad (8-56)$$

where ROP = percent runoff.

(d) Base-flow separation. An empirical relation between a base-flow infiltration index and percent of runoff to base-flow is used to divide outflow from the soil moisture zone into direct runoff and base-flow (e.g., Figure 8-14). The base-flow infiltration index is computed as:

$$BII_2 = BII_1 + 24 \left(\frac{RGP}{PH} - BII_1 \right) \frac{PH}{BIITS + \frac{PH}{2}} \quad (8-57)$$

$$BII_2 \leq BIIMX$$

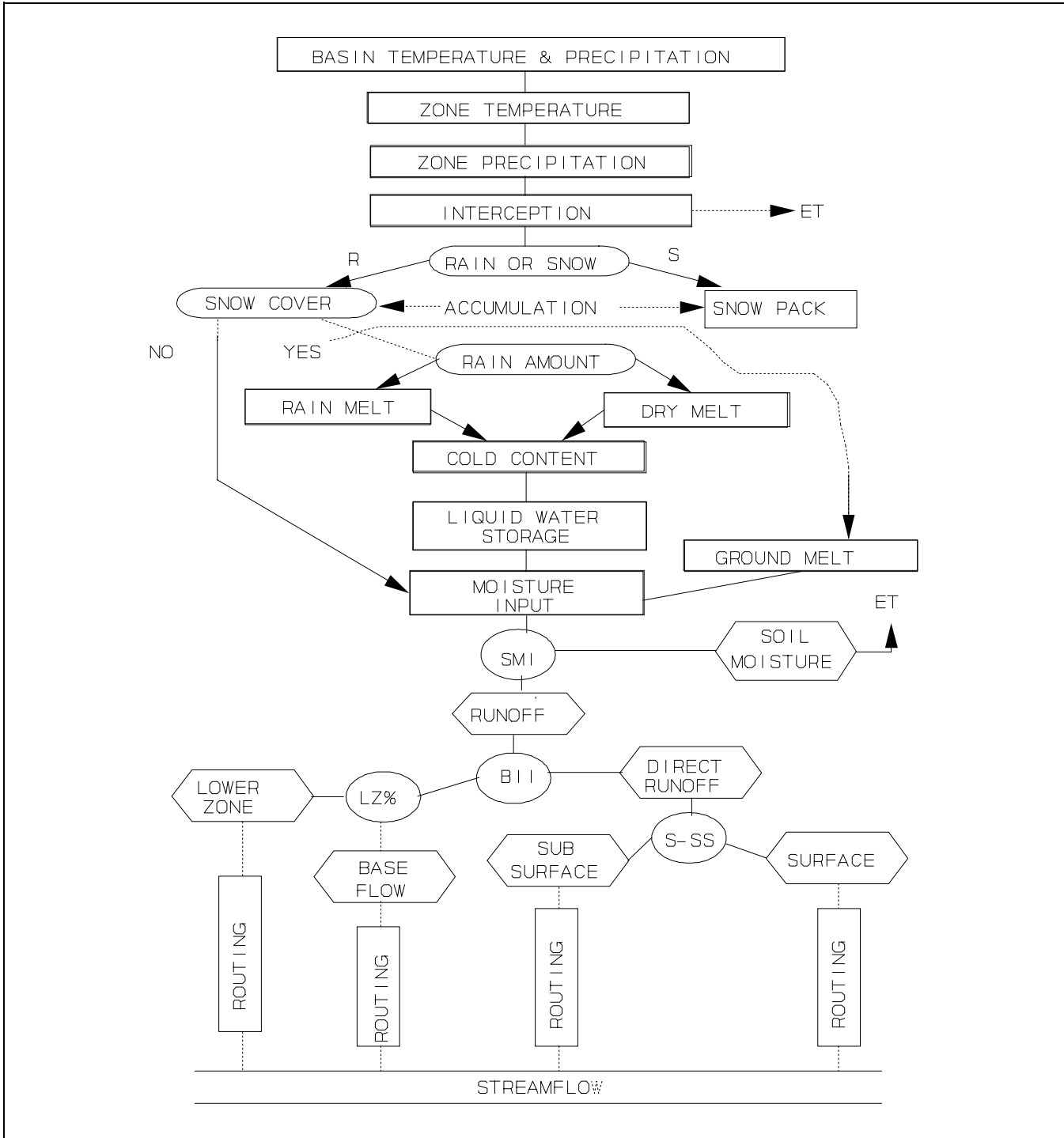

Figure 8-11. SSARR "snowbank" watershed model

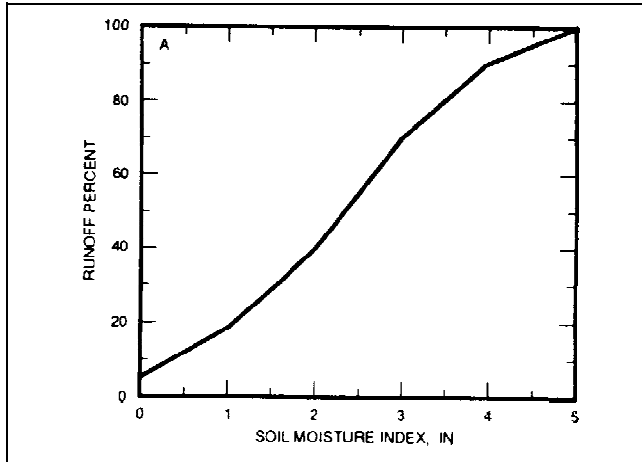

Figure 8-12. SSARR SMI versus runoff percent

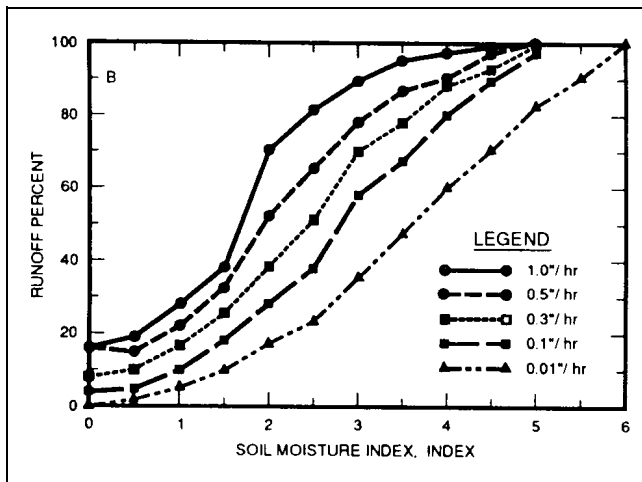

Figure 8-13. SSARR SMI versus precipitation intensity and runoff percent

or

$$BII_2 = BIIMX \quad BII_2 > BIIMX \quad (8-58)$$

where

BII_1 and BII_2 = base-flow indexes at the beginning and ending of the computational period

$BIITS$ = time delay or time of storage

$BIIMX$ = limiting value for the index

The rate of inflow to the lower and base-flow zone is then computed as:

$$TBF = BFP \left(\frac{RGP}{PH} \right) \quad (8-59)$$

where BFP is determined from Figure 8-14 using BII .

(e) Lower zone versus base flow. The lower zone and base-flow components are separated based on a user-defined factor $PBLZ$:

$$LZ = TBF(PBLZ) \quad (8-60)$$

where LZ is the inflow rate to the lower zone, up to a value $DGWLIM$. The difference between LZ and TBF is the contribution to base flow.

(f) Direct runoff. The inflow to direct runoff is the difference between the outflow from the soil moisture zone and the inflow to the base-flow zone:

$$RGS = RG - TBF \quad (8-61)$$

Surface and subsurface runoff are distinguished by a user-specified empirical relationship (e.g., Figure 8-15). The SSARR user's manual provides guidelines for developing this relationship.

(g) Routing flows to outlet. Surface, subsurface, lower zone, and base flows are routed to the outlet via linear reservoir routing. The user may separately specify the number of linear storages for each outflow component.

8-6. Parameter Estimation for Continuous Simulation Models

a. Parameter estimation. Parameter estimation for continuous simulation models is much more difficult than for event-oriented models. The reason for this is that a continuous simulation model must represent the entire hydrologic cycle. This representation requires an increase in model complexity and, correspondingly, an increase in the number of parameters to be estimated. The parameter estimation process requires an extensive amount of data and user experience. A totally ungauged parameter estimation procedure is not practical or advisable.

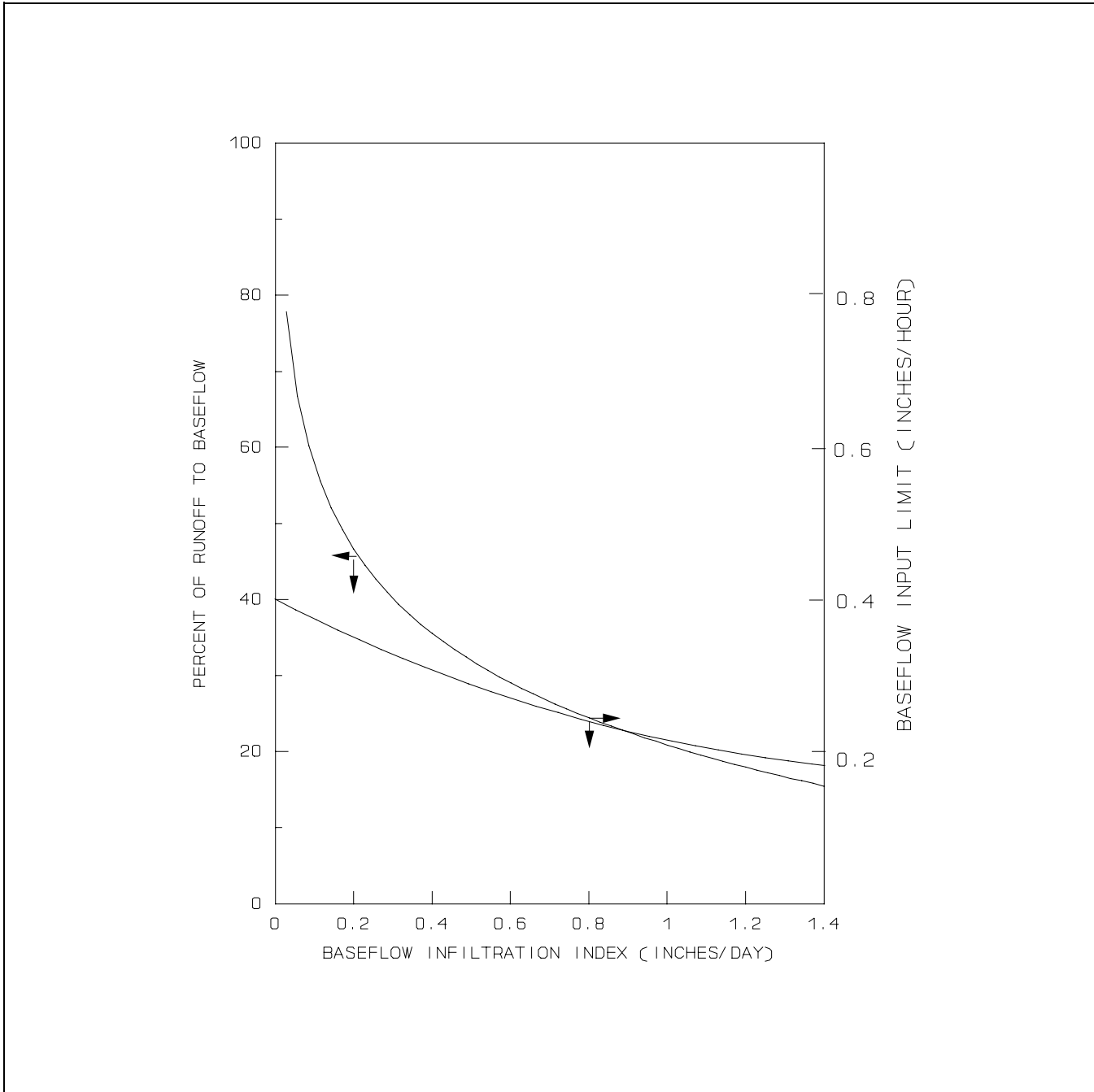

Figure 8-14. SSARR base-flow infiltration index (BII) versus base-flow percent (BFP)

b. Conceptual model. A conceptual model which is applicable to all watersheds does not exist. The subsurface characteristics of watersheds, and consequently the base-flow response, will vary. This variation will require different model representations to capture the subsurface response. Consequently, the conceptualization of the base-flow response by the number of storage zones or

tanks in the model is, in some sense, a parameter estimation decision. A single subsurface tank may be sufficient for small watersheds with limited base-flow response, and multiple zones or tanks might be necessary for watersheds that have a complicated base-flow response. At the very least, a particular conceptual model should allow flexibility in the number of subsurface zones

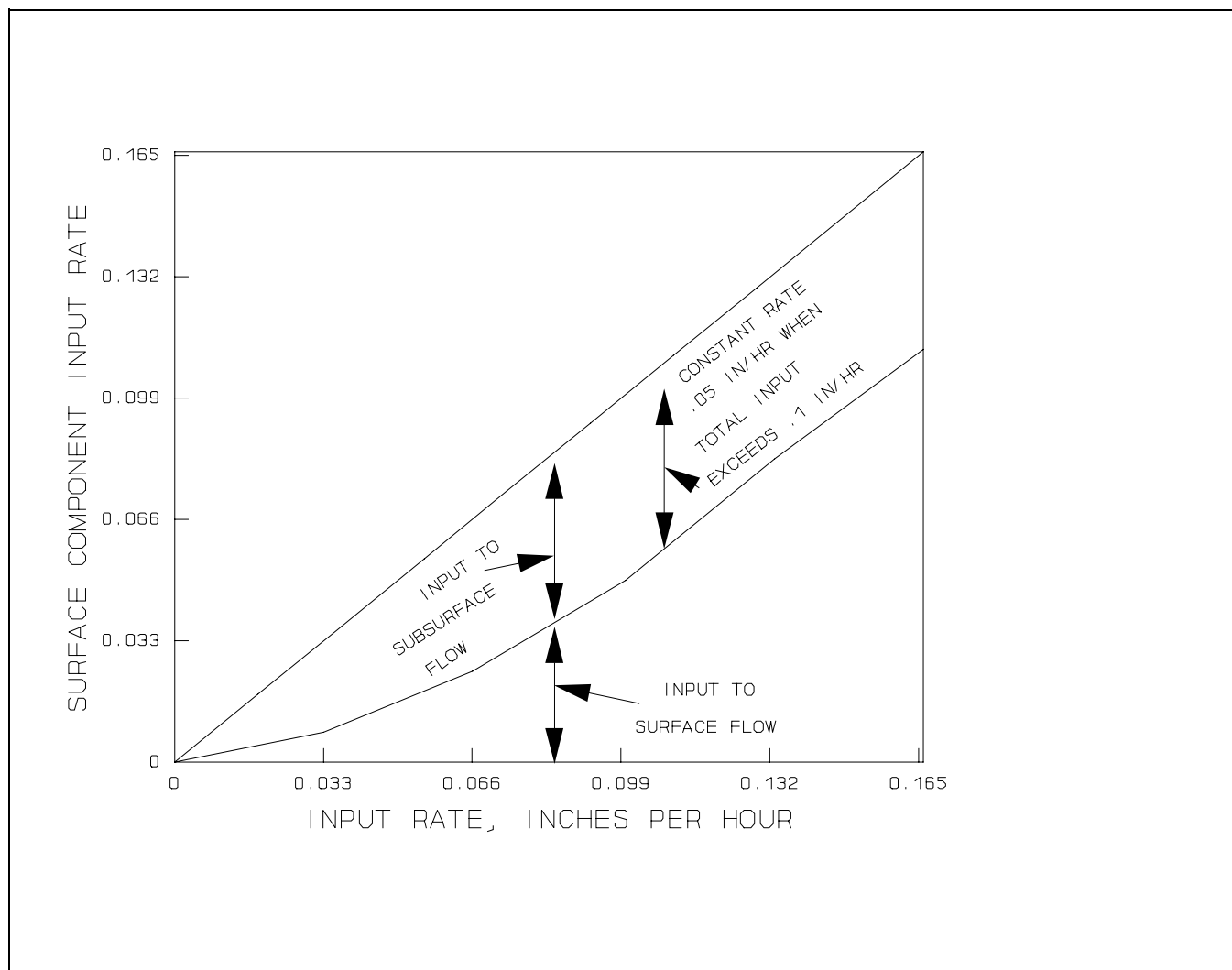

Figure 8-15. Surface - subsurface separation

that can be used to model subsurface response. The engineer would be well advised to find a model that has been successfully calibrated for a watershed that is similar to the one under investigation and subject to the same meteorologic conditions. Previous experience will help in selecting the appropriate structure for the model.

c. Previous experience. If no previous experience exists, then the structure of the model required depends on hydrograph recession analysis. The hydrograph recession analysis is an important aspect of an overall parameter estimation procedure which will be discussed subsequently.

(1) A general procedure for estimating parameters is to examine the hydrometeorologic record for errors, perform a water balance to determine ET, estimate

parameters based on event analysis and watershed physical characteristics, and apply automatic parameter estimation to fine tune parameters. An automatic parameter estimation procedure, if available, can only be used to estimate a handful of parameters, eight at the very most, preferably four or less. The automatic procedure is very useful when the number of parameters is limited, as in the case of event-oriented modeling. However, the large number of parameters available for continuous models requires that most of these parameters be estimated prior to application of an automatic procedure.

(2) Many of the continuous model parameters have a similar effect on the predicted hydrograph. An optimization procedure cannot distinguish between these parameters for this reason. The impact of each parameter must be examined in context with the physics of the process

affecting hydrographs. Available automatic parameter estimation algorithms have not been developed which can consider the physics of the problem as part of the fitting procedure.

d. Experience in applying model. Burnash (1985), who developed and has had extensive experience in applying the Sacramento Model (a conceptual continuous simulation model), recommends the first three steps mentioned when estimating parameters. Although his recommendations were directed toward the Sacramento model, they are equally applicable to other continuous models.

(1) Examination of hydrometeorologic record for errors. Burnash is convinced that the major deficiency in hydrometeorologic record is the potential underestimation of rainfall by raingauges due to wind effects. The underestimation is on the order of 10 to 15 percent. The error may not be consistent and is likely to affect large events where wind speeds are the greatest. Other factors that contribute to errors in the record are change in gauge location, gauge type, or in the environment surrounding the gauge which changes local wind patterns.

(a) Burnash makes some suggestions to identify and correct this problem. For these reasons and others, a careful application of the Sacramento Watershed Model or, for that matter, the basic water balance equation requires a continuous comparative analysis of rainfall and runoff records to describe an unusual pattern which may be a result of data inconsistencies rather than a true event. Implicit in these comments is the notion that the rainfall input should be scaled to arrive at a consistent rainfall-runoff record.

(b) Discharge measurements, particularly for large flows, may have large errors due to ill-defined rating curves. Although not explicitly stated, Burnash seems to be warning against accepting streamflow measurements that are inconsistent with the rest of the record which, in turn, would distort model parameters in the estimation process.

(2) Water balance preservation. A successful parameter estimation procedure depends on preserving the fundamental water balance equation:

$$\text{Runoff} = \text{Precipitation} - \text{Evapotranspiration}$$

Estimation of evapotranspiration is difficult because the most common indicator used is evaporation, most commonly estimated by evaporation pans. Evaporation is a very different process from ET and a poor indicator as

well. Burnash cautions against using evaporation as the final arbitrator of ET; evaporation may be used as an aid in preserving the fundamental water balance equation.

(3) Parameters from event analysis. The key to estimating continuous simulation model parameters is to identify circumstances in the hydrologic record where the individual parameter has the most effect. This may be accomplished by examining different events or an aspect of the hydrograph where a particular parameter is of first-order importance.

(a) The impervious area fraction of the basin may be identified by examining direct runoff when antecedent precipitation conditions are extremely dry. The direct runoff in these circumstance would be due to the impervious fraction.

(b) As antecedent precipitation increases, there will be an increase in direct runoff from a larger portion of the watershed. The maximum fraction of area that contributes to direct runoff will occur under the wettest conditions. The partial area correction, the relationship between basin contribution to direct runoff and basin moisture conditions, can be developed from examining the basin response from wet to dry antecedent conditions.

(c) The soil profile zone capacity can be estimated by examining prediction errors when the soil moisture deficit should be small. Presumably, an overprediction of runoff will indicate that the soil profile capacity has been underestimated.

(d) The subsurface response characteristics are determined by performing hydrograph recession analysis as discussed in paragraph 8-2 on event-oriented modeling of base flow. However, the recession analysis tends to be more detailed than in the event case. The continuous simulation analysis endeavors to identify different levels of aquifer response characteristics by identifying straight line segments on a log-discharge versus time plot. Burnash cautions that deviations from the straight line recession may occur due to channel losses or riparian vegetation ET. The impact of channel losses may be discerned by examining the deviations from a straight line during periods when ET is low. The recession can then be corrected for channel loss and then used to examine the impact of ET on the recession during high ET periods.

(e) Burnash does not discuss the use of automatic parameter estimation or optimization algorithms for estimating parameters. However, his recommended estimation techniques should be used to reduce the number of

parameters that will be used when estimating parameters via an optimization approach. Optimization techniques are only useful when the number of parameters are limited to less than eight and preferably less than four.

Consequently, optimization or automatic parameter estimation will probably be used to fine tune parameter estimates obtained by event analysis and application of the water balance equation.

Chapter 9 Streamflow and Reservoir Routing

9-1. General

a. Routing is a process used to predict the temporal and spatial variations of a flood hydrograph as it moves through a river reach or reservoir. The effects of storage and flow resistance within a river reach are reflected by changes in hydrograph shape and timing as the floodwave moves from upstream to downstream. Figure 9-1 shows the major changes that occur to a discharge hydrograph as a floodwave moves downstream.

b. In general, routing techniques may be classified into two categories: hydraulic routing, and hydrologic routing. Hydraulic routing techniques are based on the solution of the partial differential equations of unsteady open channel flow. These equations are often

referred to as the St. Venant equations or the dynamic wave equations. Hydrologic routing employs the continuity equation and an analytical or an empirical relationship between storage within the reach and discharge at the outlet.

c. Flood forecasting, reservoir and channel design, floodplain studies, and watershed simulations generally utilize some form of routing. Typically, in watershed simulation studies, hydrologic routing is utilized on a reach-by-reach basis from upstream to downstream. For example, it is often necessary to obtain a discharge hydrograph at a point downstream from a location where a hydrograph has been observed or computed. For such purposes, the upstream hydrograph is routed through the reach with a hydrologic routing technique that predicts changes in hydrograph shape and timing. Local flows are then added at the downstream location to obtain the total flow hydrograph. This type of approach is adequate as long as there are no significant backwater effects or

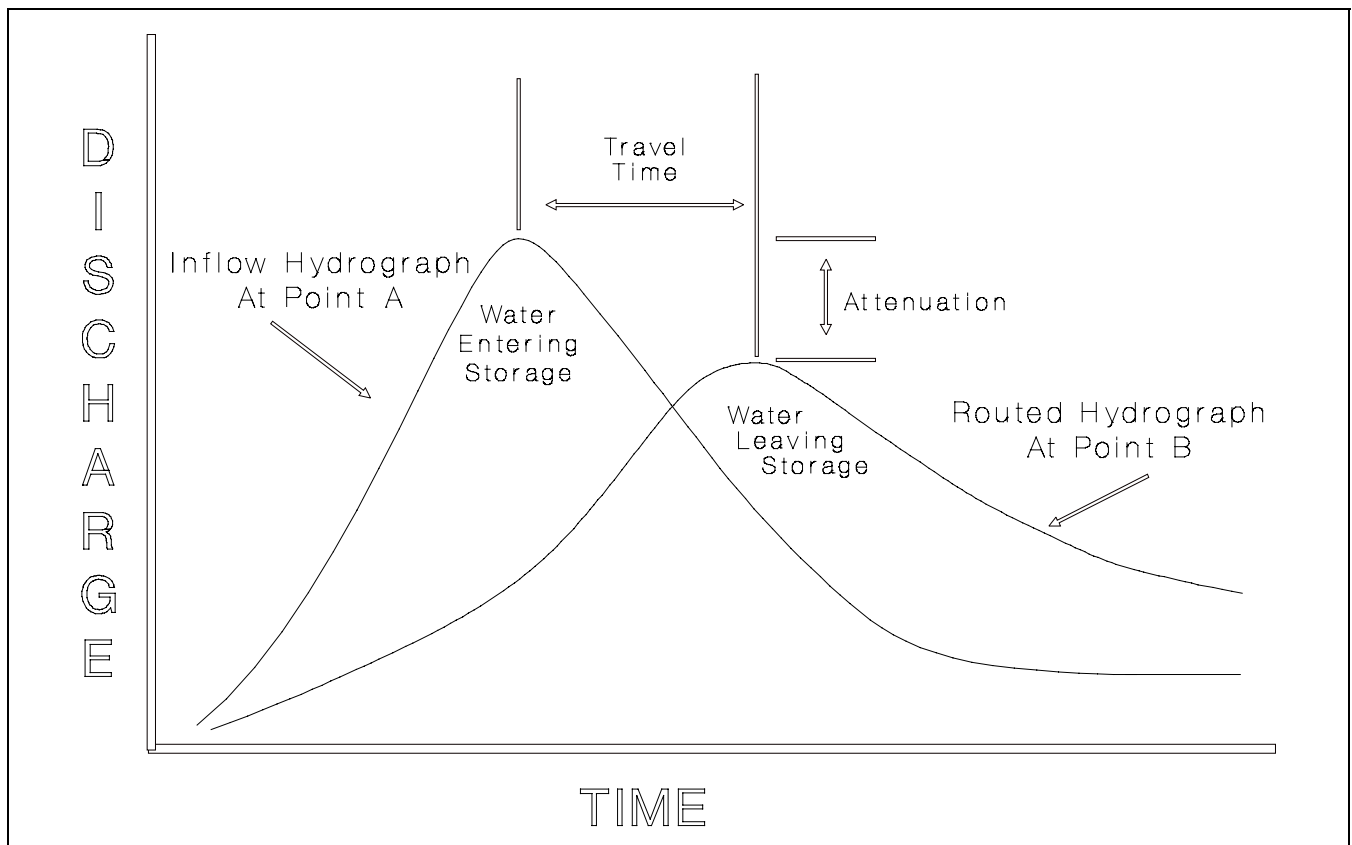

Figure 9-1. Discharge hydrograph routing effects

discontinuities in the water surface because of jumps or bores. When there are downstream controls that will have an effect on the routing process through an upstream reach, the channel configuration should be treated as one continuous system. This can only be accomplished with a hydraulic routing technique that can incorporate backwater effects as well as internal boundary conditions, such as those associated with culverts, bridges, and weirs.

d. This chapter describes several different hydraulic and hydrologic routing techniques. Assumptions, limitations, and data requirements are discussed for each. The basis for selection of a particular routing technique is reviewed, and general calibration methodologies are presented. This chapter is limited to discussions on 1-D flow routing techniques in the context of flood-runoff analysis. The focus of this chapter is on discharge (flow) rather than stage (water surface elevation). Detailed presentation of routing techniques and applications focused on stage calculations can be found in EM 1110-2-1416.

9-2. Hydraulic Routing Techniques

a. The equations of motion. The equations that describe 1-D unsteady flow in open channels, the Saint Venant equations, consist of the continuity equation, Equation 9-1, and the momentum equation, Equation 9-2. The solution of these equations defines the propagation of a floodwave with respect to distance along the channel and time.

$$A \frac{\partial V}{\partial x} + VB \frac{\partial y}{\partial x} + B \frac{\partial y}{\partial t} = q \quad (9-1)$$

$$S_f = S_o - \frac{\partial y}{\partial x} - \frac{V}{g} \frac{\partial V}{\partial x} - \frac{1}{g} \frac{\partial V}{\partial t} \quad (9-2)$$

where

A = cross-sectional flow area

V = average velocity of water

x = distance along channel

B = water surface width

y = depth of water

t = time

q = lateral inflow per unit length of channel

S_f = friction slope

S_o = channel bed slope

g = gravitational acceleration

Solved together with the proper boundary conditions, Equations 9-1 and 9-2 are the complete dynamic wave equations. The meaning of the various terms in the dynamic wave equations are as follows (Henderson 1966):

(1) Continuity equation.

$$A \frac{\partial V}{\partial x} = \text{prism storage}$$

$$VB \frac{\partial y}{\partial x} = \text{wedge storage}$$

$$B \frac{\partial y}{\partial t} = \text{rate of rise}$$

$$q = \text{lateral inflow per unit length}$$

(2) Momentum equation.

$$S_f = \text{friction slope (frictional forces)}$$

$$S_o = \text{bed slope (gravitational effects)}$$

$$\frac{\partial y}{\partial x} = \text{pressure differential}$$

$$\frac{V}{g} \frac{\partial V}{\partial x} = \text{convective acceleration}$$

$$\frac{1}{g} \frac{\partial V}{\partial t} = \text{local acceleration}$$

(3) Dynamic wave equations. The dynamic wave equations are considered to be the most accurate and comprehensive solution to 1-D unsteady flow problems in open channels. Nonetheless, these equations are based on specific assumptions, and therefore have limitations. The assumptions used in deriving the dynamic wave equations are as follows:

(a) Velocity is constant and the water surface is horizontal *across* any channel section.

(b) All flows are gradually varied with hydrostatic pressure prevailing at all points in the flow, such that vertical accelerations can be neglected.

(c) No lateral secondary circulation occurs.

(d) Channel boundaries are treated as fixed; therefore, no erosion or deposition occurs.

(e) Water is of uniform density, and resistance to flow can be described by empirical formulas, such as Manning's and Chezy's equation.

(f) The dynamic wave equations can be applied to a wide range of 1-D flow problems; such as, dam break floodwave routing, forecasting water surface elevations and velocities in a river system during a flood, evaluating flow conditions due to tidal fluctuations, and routing flows through irrigation and canal systems. Solution of the full equations is normally accomplished with an explicit or implicit finite difference technique. The equations are solved for incremental times (Δt) and incremental distances (Δx) along the waterway.

b. *Approximations of the full equations.* Depending on the relative importance of the various terms of the momentum Equation 9-2, the equation can be simplified for various applications. Approximations to the full dynamic wave equations are created by combining the continuity equation with various simplifications of the momentum equation. The most common approximations of the momentum equation are:

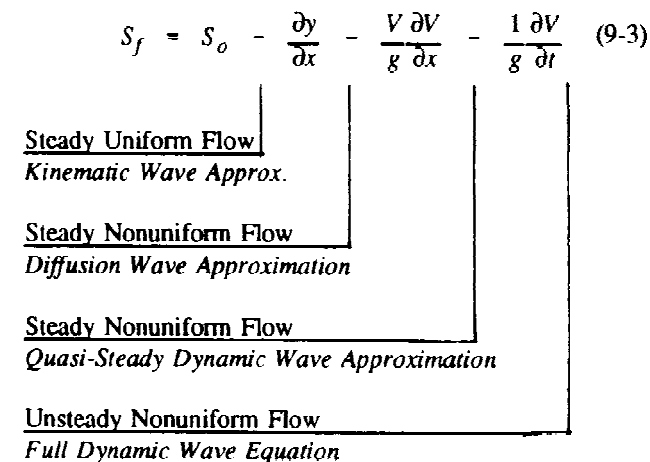

The use of approximations to the full equations for unsteady flow can be justified when specific terms in the momentum equation are small in comparison to the bed slope. This is best illustrated by an example taken from Henderson's book *Open Channel Flow* (1966). Henderson computed values for each of the terms on the right-hand side of the momentum equation for a steep alluvial stream:

Term:	S_o	$\frac{\partial y}{\partial x}$	$\frac{V \partial V}{g \partial x}$	$\frac{1 \partial V}{g \partial t}$
Magnitude (ft/mi):	26	.5	.12-.25	.05

These figures relate to a very fast rising hydrograph in which the flow increased from 10,000 to 150,000 cfs and decreased again to 10,000 cfs within 24 hr. Even in this case, where changes in depth and velocity with respect to distance and time are relatively large, the last three terms are still small in comparison to the bed slope. For this type of flow situation (steep stream), an approximation of the full equations would be appropriate. For flatter slopes, the last three terms become increasingly more important.

(1) Kinematic wave approximation. Kinematic flow occurs when gravitational and frictional forces achieve a balance. In reality, a true balance between gravitational and frictional forces never occurs. However, there are flow situations in which gravitational and frictional forces approach an equilibrium. For such conditions, changes in depth and velocity with respect to time and distance are small in magnitude when compared to the bed slope of the channel. Therefore, the terms to the right of the bed slope in Equation 9-3 are assumed to be negligible. This assumption reduces the momentum equation to the following:

$$S_f = S_o \quad (9-4)$$

Equation 9-4 essentially states that the momentum of the flow can be approximated with a uniform flow assumption as described by Manning's or Chezy's equation. Manning's equation can be written in the following form:

$$Q = \alpha A^m \quad (9-5)$$

where α and m are related to flow geometry and surface roughness

Since the momentum equation has been reduced to a simple functional relationship between area and discharge, the movement of a floodwave is described solely by the continuity equation, written in the following form:

$$\frac{\partial A}{\partial t} + \frac{\partial Q}{\partial x} = q \quad (9-6)$$

Then by combining Equations 9-5 and 9-6, the governing kinematic wave equation is obtained as:

$$\frac{\partial A}{\partial t} + \alpha mA^{(m-1)} \frac{\partial A}{\partial x} = q \quad (9-7)$$

Because of the steady uniform flow assumptions, the kinematic wave equations do not allow for hydrograph diffusion, just simple translation of the hydrograph in time. The kinematic wave equations are usually solved by explicit or implicit finite difference techniques. Any attenuation of the peak flow that is computed using the kinematic wave equations is due to errors inherent in the finite difference solution scheme.

(a) The application of the kinematic wave equation is limited to flow conditions that do not demonstrate appreciable hydrograph attenuation. In general, the kinematic wave approximation works best when applied to steep (10 ft/mile or greater), well defined channels, where the floodwave is gradually varied.

(b) The kinematic wave approach is often applied in urban areas because the routing reaches are generally short and well defined (i.e., circular pipes, concrete lined channels, etc.).

(c) The kinematic wave equations cannot handle backwater effects since, with a kinematic model flow, disturbances can only propagate in the downstream direction. All of the terms in the momentum equation that are used to describe the propagation of the floodwave upstream (backwater effects) have been excluded.

(2) Diffusion wave approximation. Another common approximation of the full dynamic wave equations is the diffusion wave analogy. The diffusion wave model utilizes the continuity Equation 9-1 and the following simplified form of the momentum equation:

$$S_f = S_o - \frac{\partial y}{\partial x} \quad (9-8)$$

The diffusion wave model is a significant improvement over the kinematic wave model because of the inclusion of the pressure differential term in Equation 9-8. This term allows the diffusion model to describe the attenuation (diffusion effect) of the floodwave. It also allows the specification of a boundary condition at the downstream extremity of the routing reach to account for backwater effects. It does not use the inertial terms (last two terms) from Equation 9-2 and, therefore, is limited to slow to moderately rising floodwaves (Fread 1982). However, most natural floodwaves can be described with the diffusion form of the equations.

(3) Quasi-steady dynamic wave approximation. The third simplification of the full dynamic wave equations is the quasi-steady dynamic wave approximation. This model utilizes the continuity equation, Equation 9-1, and the following simplification of the momentum equation:

$$S_f = S_o - \frac{\partial y}{\partial x} - \frac{V}{g} \frac{\partial V}{\partial x} \quad (9-9)$$

In general, this simplification of the dynamic wave equations is not used in flood routing. This form of the momentum equation is more commonly used in steady flow-water surface profile computations. In the case of flood routing, the last two terms on the momentum equation are often opposite in sign and tend to counteract each other (Fread 1982). By including the convective acceleration term and not the local acceleration term, an error is introduced. This error is of greater magnitude than the error that results when both terms are excluded, as in the diffusion wave model. For steady flow-water surface profiles, the last term of the momentum equation (changes in velocity with respect to time) is assumed to be zero. However, changes in velocity with respect to distance are still very important in the calculation of steady flow-water surface profiles.

c. Data requirements. In general, the data requirements of the various hydraulic routing techniques are virtually the same. However, the amount of detail that is required for each type of data will vary depending upon the routing technique being used and the situation it is being applied to. The basic data requirements for hydraulic routing techniques are the following:

- (1) Flow data (hydrographs).
- (2) Channel cross sections and reach lengths.
- (3) Roughness coefficients.
- (4) Initial and boundary conditions.

(a) Flow data consist of discharge hydrographs from upstream locations as well as lateral inflow and tributary flow for all points along the stream.

(b) Channel cross sections are typically surveyed sections that are perpendicular to the flow lines. Key issues in selecting cross sections are the accuracy of the surveyed data and the spacing of the sections along the stream. If the routing procedure is utilized to predict stages, then the accuracy of the cross-sectional dimensions will have a direct effect on the prediction of the stage. If the cross sections are used only to route discharge hydrographs, then it is only important to ensure that the cross section is an adequate representation of the discharge versus flow area of the section. Simplified cross-sectional shapes, such as 8-point cross sections or trapezoids and rectangles, are often used to fit the discharge versus flow area of a more detailed section. Cross-sectional spacing affects the level of detail of the results as well as the accuracy of the numerical solution to the routing equations. Detailed discussions on cross-sectional spacing can be found in the reference by the Hydrologic Engineering Center (HEC) (USACE 1986).

(c) Roughness coefficients for hydraulic routing models are typically in the form of Manning's n values. Manning's coefficients have a direct impact on the travel time and amount of diffusion that will occur when routing a flood hydrograph through a channel reach. Roughness coefficients will also have a direct impact on predicted stages.

(d) All hydraulic models require that initial and boundary conditions be established before the routing can commence. Initial conditions are simply stated as the conditions at all points in the stream at the beginning of the simulation. Initial conditions are established by specifying a base flow within the channel at the start of the simulation. Channel depths and velocities can be calculated through steady-state backwater computations or a normal depth equation (e.g., Manning's equation). Boundary conditions are known relationships between discharge and time and/or discharge and stage. Hydraulic routing computations require the specification of upstream, downstream, and internal boundary conditions

to solve the equations. The upstream boundary condition is the discharge (or stage) versus time relationship of the hydrograph to be routed through the reach. Downstream boundary conditions are usually established with a steady-state rating curve (discharge versus depth relationship) or through normal depth calculations (Manning's equation). Internal boundary conditions consist of lateral inflow or tributary flow hydrographs, as well as depth versus discharge relationships for hydraulic structures within the river reach.

9-3. Hydrologic Routing Techniques

Hydrologic routing employs the use of the continuity equation and either an analytical or an empirical relationship between storage within the reach and discharge at the outlet. In its simplest form, the continuity equation can be written as inflow minus outflow equals the rate of change of storage within the reach:

$$I - O = \frac{\Delta S}{\Delta t} \quad (9-10)$$

where

I = the average inflow to the reach during Δt

O = the average outflow from the reach during Δt

S = storage within the reach

a. Modified puls reservoir routing.

(1) One of the simplest routing applications is the analysis of a floodwave that passes through an unregulated reservoir (Figure 9-2a). The inflow hydrograph is known, and it is desired to compute the outflow hydrograph from the reservoir. Assuming that all gate and spillway openings are fixed, a unique relationship between storage and outflow can be developed, as shown in Figure 9-2b.

(2) The equation defining storage routing, based on the principle of conservation of mass, can be written in approximate form for a routing interval Δt . Assuming the subscripts "1" and "2" denote the beginning and end of the routing interval, the equation is written as follows:

$$\frac{O_1 + O_2}{2} = \frac{I_1 + I_2}{2} - \frac{S_2 - S_1}{\Delta t} \quad (9-11)$$

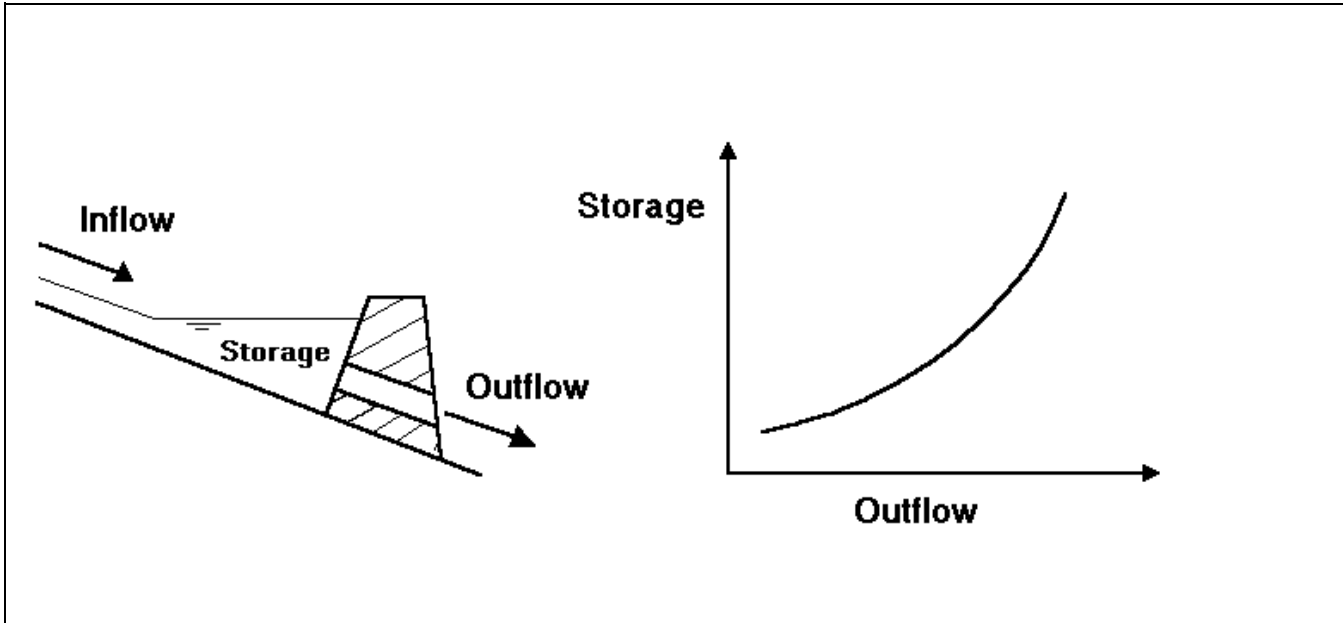

Figure 9-2. Reservoir storage routing

The known values in this equation are the inflow hydrograph and the storage and discharge at the beginning of the routing interval. The unknown values are the storage and discharge at the end of the routing interval. With two unknowns (O_2 and S_2) remaining, another relationship is required to obtain a solution. The storage-outflow relationship is normally used as the second equation. How that relationship is derived is what distinguishes various storage routing methods.

(3) For an uncontrolled reservoir, outflow and water in storage are both uniquely a function of lake elevation. The two functions can be combined to develop a storage-outflow relationship, as shown in Figure 9-3. Elevation-discharge relationships can be derived directly from hydraulic equations. Elevation-storage relationships are derived through the use of topographic maps. Elevation-area relationships are computed first, then either average end-area or conic methods are used to compute volumes.

(4) The storage-outflow relationship provides the outflow for any storage level. Starting with a nearly empty reservoir, the outflow capability would be minimal. If the inflow is less than the outflow capability, the water would flow through. During a flood, the inflow increases and eventually exceeds the outflow capability. The difference between inflow and outflow produces a change in storage. In Figure 9-4, the difference between the inflow and the outflow (on the rising side of the outflow hydrograph) represents the volume of water entering storage.

(5) As water enters storage, the outflow capability increases because the pool level increases. Therefore, the outflow increases. This increasing outflow with increasing water in storage continues until the reservoir reaches a maximum level. This will occur the moment that the outflow equals the inflow, as shown in Figure 9-4. Once the outflow becomes greater than the inflow, the storage level will begin dropping. The difference between the outflow and the inflow hydrograph on the recession side reflects water withdrawn from storage.

(6) The modified puls method applied to reservoirs consists of a repetitive solution of the continuity equation. It is assumed that the reservoir water surface remains horizontal, and therefore, outflow is a unique function of reservoir storage. The continuity equation, Equation 9-11, can be manipulated to get both of the unknown variables on the left-hand side of the equation:

$$\left(\frac{S_2}{\Delta t} + \frac{O_2}{2} \right) = \left(\frac{S_1}{\Delta t} + \frac{O_1}{2} \right) - O_1 + \frac{I_1 + I_2}{2} \quad (9-12)$$

Since I is known for all time steps, and O_1 and S_1 are known for the first time step, the right-hand side of the equation can be calculated. The left-hand side of the equation can be solved by trial and error. This is accomplished by assuming a value for either S_2 or O_2 , obtaining the corresponding value from the storage-outflow relationship, and then iterating until Equation 9-12 is satisfied.

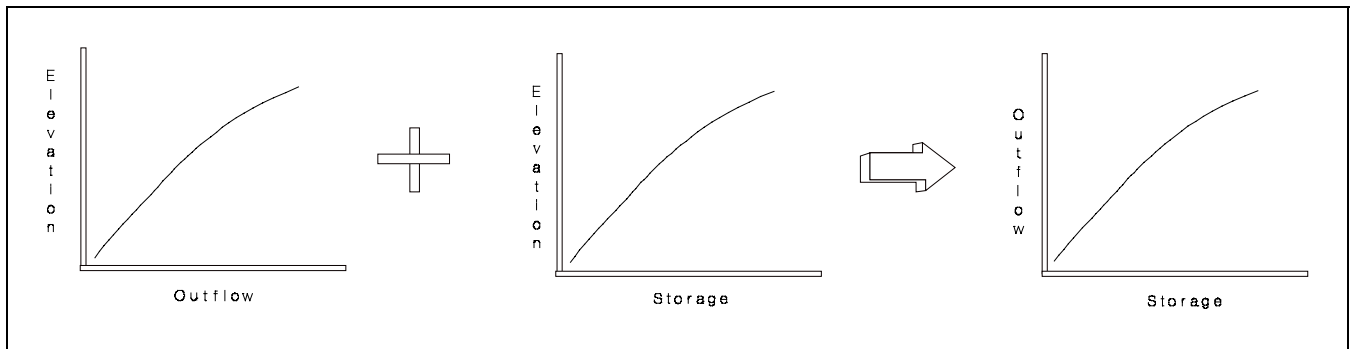

Figure 9-3. Reservoir storage-outflow curve

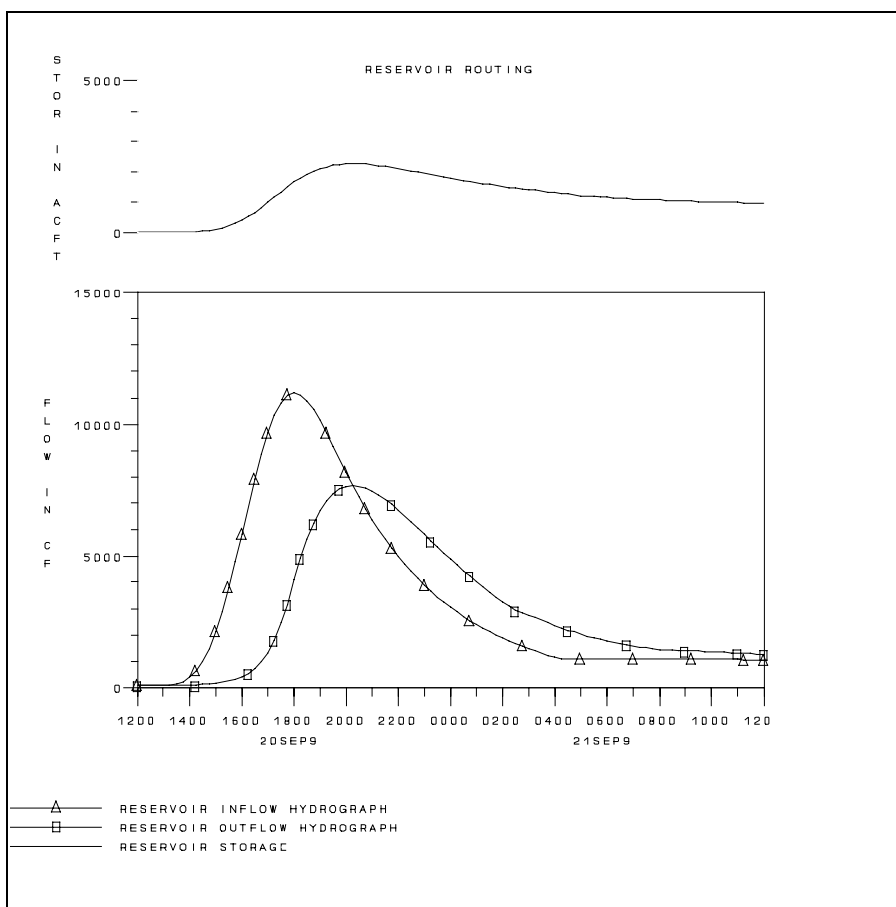

Figure 9-4. Reservoir routing example

Rather than resort to this iterative procedure, a value of Δt is selected and points on the storage-outflow curve are replotted as the “storage-indication” curve shown in Figure 9-5. This graph allows for a direct determination of the outflow (O_2) once a value of storage indication ($S_2/\Delta t + O_2/2$) has been calculated from Equation 9-12

(Viessman et al. 1977). The numerical integration of Equation 9-12 and Figure 9-5 is illustrated as an example in Table 9-1. The stepwise procedure for applying the modified puls method to reservoirs can be summarized as follows:

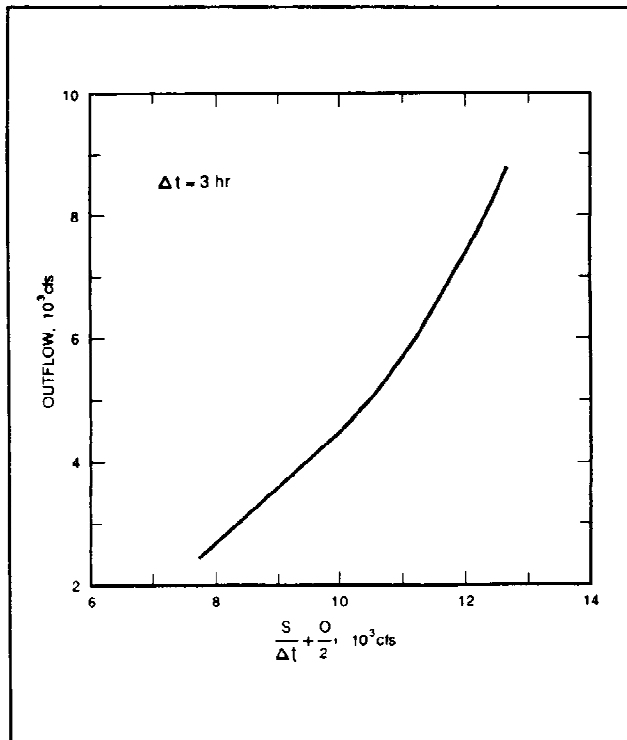

Figure 9-5. Storage-indication curve

(a) Determine a composite discharge rating curve for all of the reservoir outlet structures.

(b) Determine the reservoir storage that corresponds with each elevation on the rating curve for reservoir outflow.

(c) Select a time step and construct a storage-indication versus outflow curve $[(S/\Delta t) + (O/2)]$ versus O .

(d) Route the inflow hydrograph through the reservoir based on Equation 9-12 and the storage-indication curve.

(e) Compare the results with historical events to verify the model.

b. Modified puls channel routing. Routing in natural rivers is complicated by the fact that storage in a river reach is not a function of outflow alone. During the passing of a floodwave, the water surface in a channel is not uniform. The storage and water surface slope within a river reach, for a given outflow, is greater during the rising stages of a floodwave than during the falling (Figure 9-6). Therefore, the relationship between storage

and discharge at the outlet of a channel is not a unique relationship, rather it is a looped relationship. An example storage-discharge function for a river is shown in Figure 9-7.

(1) Application of the modified puls method to rivers. To apply the modified puls method to a channel routing problem, the storage within the river reach is approximated with a series of "cascading reservoirs" (Figure 9-8). Each reservoir is assumed to have a level pool and, therefore, a unique storage-discharge relationship. The cascading reservoir approach is capable of approximating the looped storage-outflow effect when evaluating the river reach as a whole. The rising and falling floodwave is simulated with different storage levels in the cascade of reservoirs, thus producing a looped storage-outflow function for the total river reach. This is depicted graphically in Figure 9-9.

(2) Determination of the storage-outflow relationship.

(a) Determining the storage-outflow relationship for a river reach is a critical part of the modified puls procedure. In river reaches, storage-outflow relationships can be determined from one of the following:

- steady-flow profile computations,
- observed water surface profiles,
- normal-depth calculations,
- observed inflow and outflow hydrographs, and
- optimization techniques applied to observed inflow and outflow hydrographs.

(b) Steady-flow water surface profiles, computed over a range of discharges, can be used to determine storage-outflow relationships in a river reach (Figure 9-10). In this illustration, a known hydrograph at A is to be routed to location B. The storage-outflow relationship required for routing is determined by computing a series of water surface profiles, corresponding to a range of discharges. The range of discharges should encompass the range of flows that will be routed through the river reach. The storage volumes are computed by multiplying the cross-sectional area, under a specific flow profile, by the channel reach lengths. Volumes are calculated for each flow profile and then plotted against

Table 9-1
Storage Routing Calculation

(1)	(2)	(3)	(4)	(5)	(6)	(7)
Time (hr)	Inflow (cfs)	Average Inflow (cfs)	$\frac{S}{\Delta t} + \frac{O}{2}$ (cfs)	Outflow (cfs)	$\frac{S}{\Delta t}$ (cfs)	S (acre-ft)
0	3,000		8,600	3,000	7,100	1,760
		3,130				
3	3,260		8,730	3,150	7,155	1,774
		3,445				
6	3,630		9,025	3,400	7,325	1,816
		3,825				
9	4,020		9,450	3,850	7,525	1,866
		4,250				
12	4,480		9,850	4,300	7,700	1,909
etc.						

the corresponding discharge at the outlet. If channel or levee modifications will have an effect on the routing through the reach, modifications can be made to the cross sections, water surface profiles recalculated, and a revised storage-outflow relationship can be developed. The impacts of the channel or levee modification can be approximated by routing floods with both pre- and post-project storage-outflow relationships.

(c) Observed water surface profiles, obtained from high water marks, can be used to compute storage-outflow relationships. Sufficient stage data over a range of floods are required for this type of calculation; however, it is not likely that enough data would be available over the range of discharges needed to compute an adequate storage discharge relationship. If a few observed profiles are available, they can be used to calibrate a steady-flow water surface profile model for the channel reach of interest. Then the water surface profile model could be used to calculate the appropriate range of values to calculate the storage-outflow relationship.

(d) Normal depth associated with uniform flow does not exist in natural streams; however, the concept can be used to estimate water depth and storage in natural rivers

if uniform flow conditions can reasonably be assumed. With a typical cross section, Manning's equation is solved for a range of discharges, given appropriate "n" values and an estimated slope of the energy grade line. Under the assumption of uniform flow conditions, the energy slope is considered equal to the average channel bed slope; therefore, this approach should not be applied in backwater areas.

(e) Observed inflow and outflow hydrographs can be used to compute channel storage by an inverse process of flood routing. When both inflow and outflow are known, the change in storage can be computed, and from that a storage versus outflow function can be developed. Tributary inflow, if any, must also be accounted for in this calculation. The total storage is computed from some base level storage at the beginning or end of the routing sequence.

(f) Inflow and outflow hydrographs can also be used to compute routing criteria through a process of iteration in which an initial set of routing criteria is assumed, the inflow hydrograph is routed, and the results are evaluated. The process is repeated as necessary until a suitable fit of the routed and observed hydrograph is obtained.

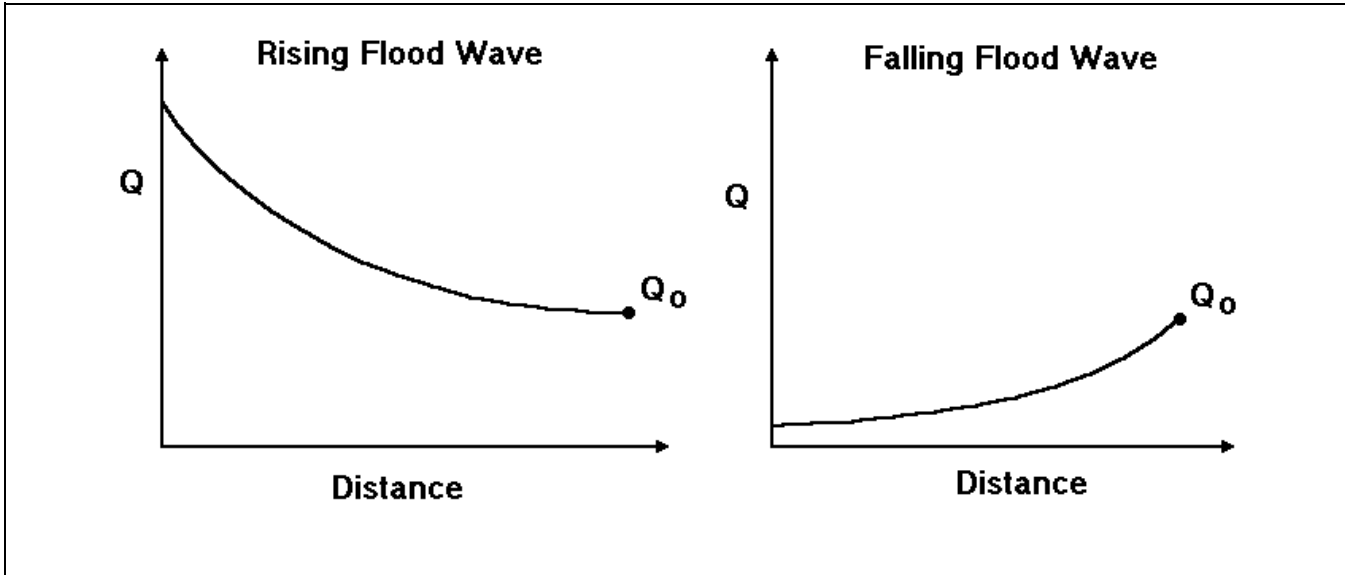

Figure 9-6. Rising and falling floodwave

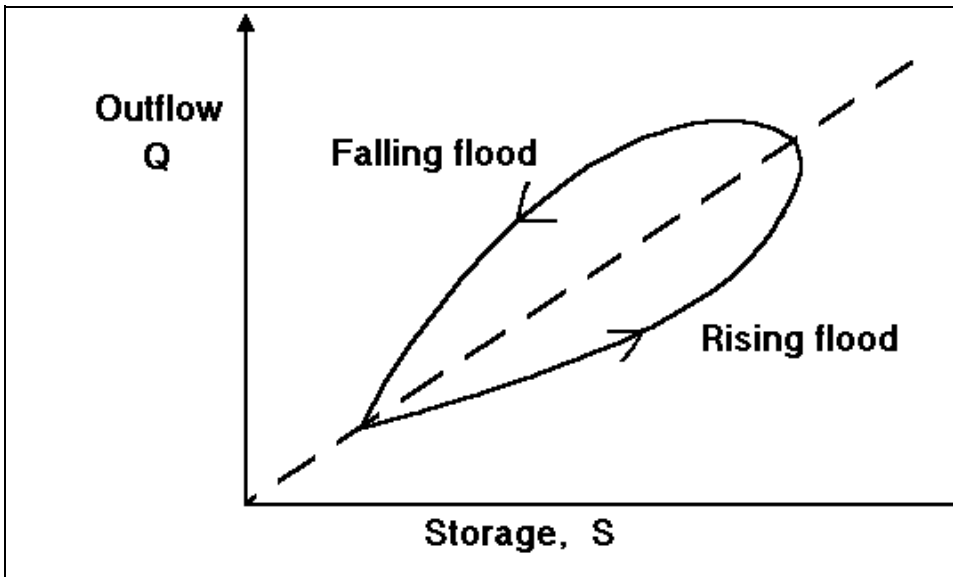

Figure 9-7. Looped storage-outflow relationship for a river reach

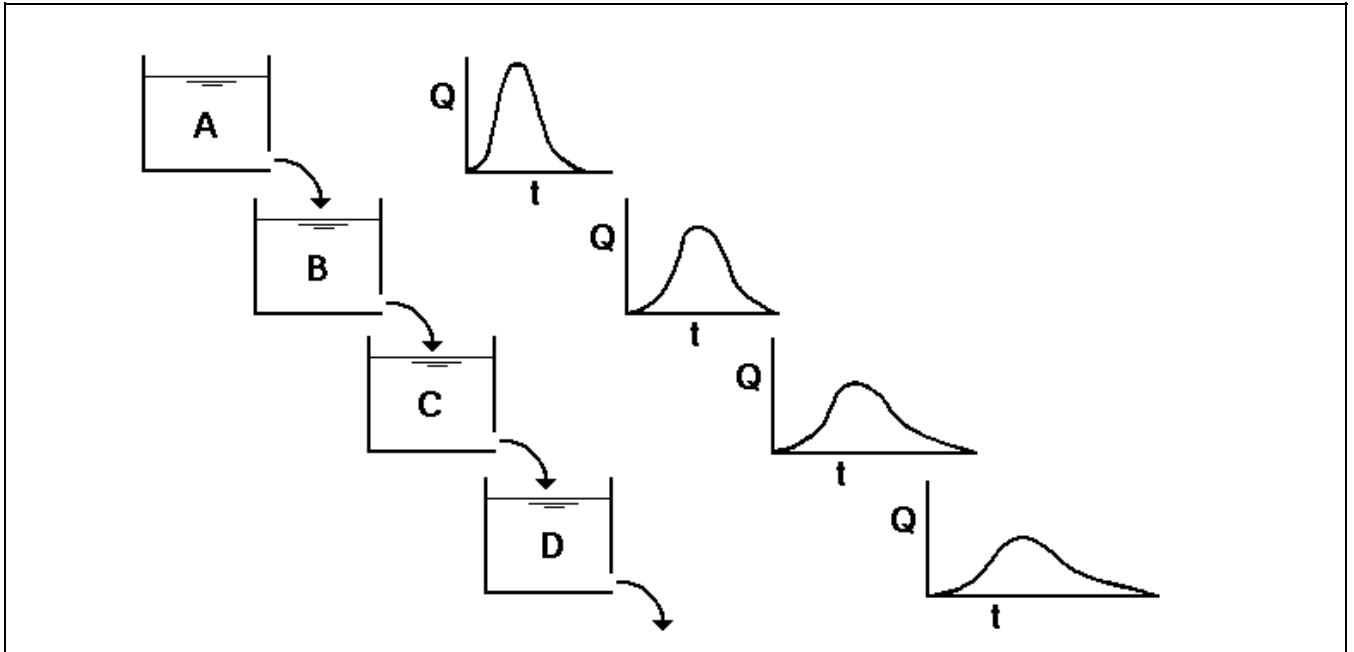

Figure 9-8. Cascade of reservoirs, depicting storage routing in a channel

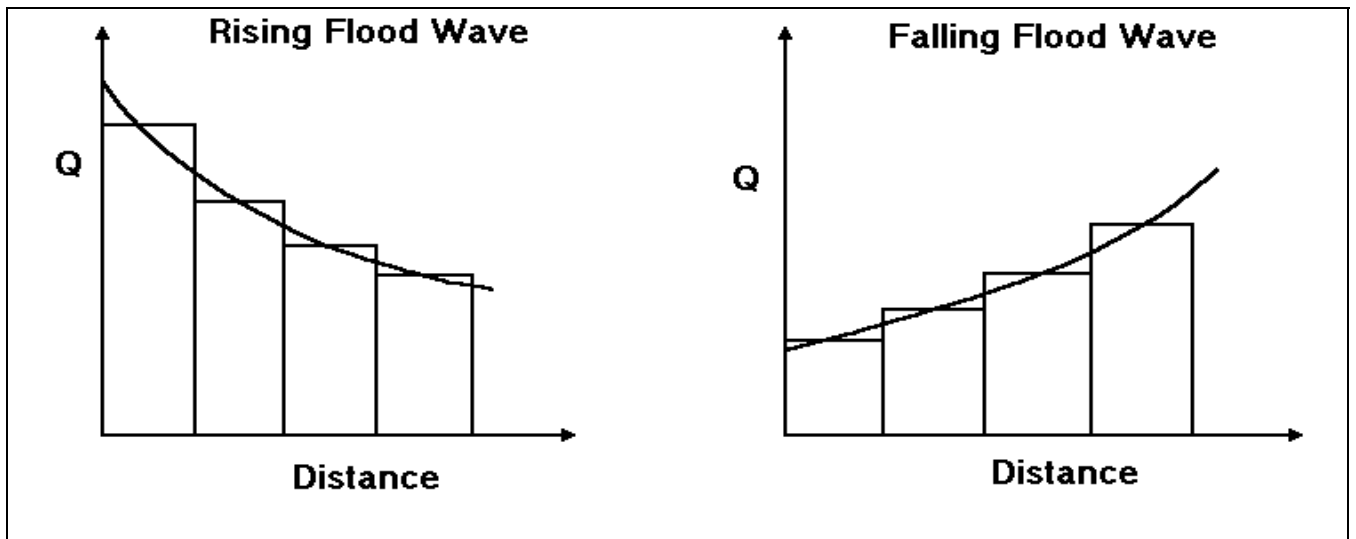

Figure 9-9. Modified puls approximation of the rising and falling floodwaves

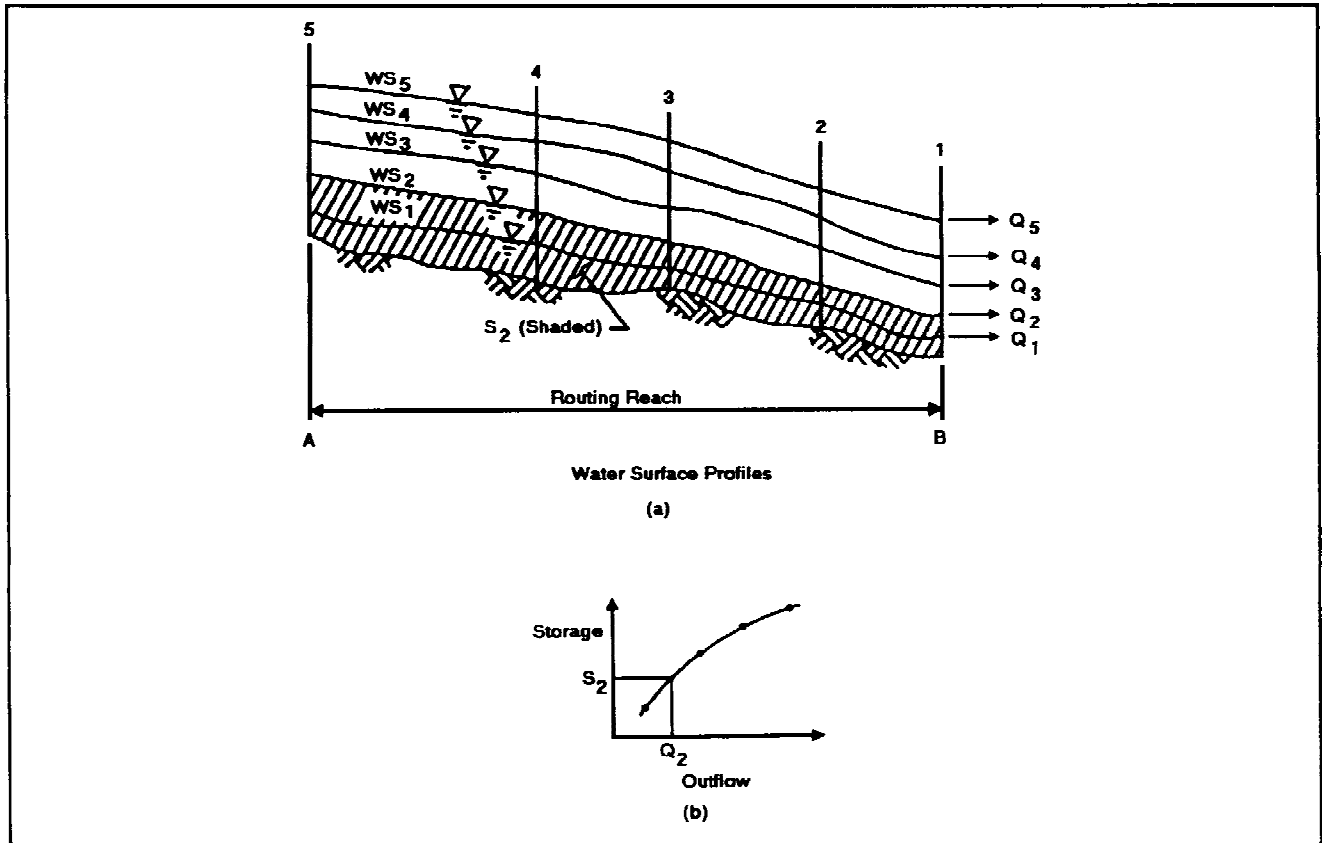

Figure 9-10. Storage-outflow relationships

(3) Determining the number of routing steps. In reservoir routing, the modified puls method is applied with one routing step. This is under the assumption that the travel time through the reservoir is smaller than the computation interval Δt . In channel routing, the travel time through the river reach is often greater than the computation interval. When this occurs, the channel must be broken down into smaller routing steps to simulate the floodwave movement and changes in hydrograph shape. The number of steps (or reach lengths) affects the attenuation of the hydrograph and should be obtained by calibration. The maximum amount of attenuation will occur when the channel routing computation is done in one step. As the number of routing steps increases, the amount of attenuation decreases. An initial estimate of the number of routing steps (NSTPS) can be obtained by dividing the total travel time (K) for the reach by the computation interval Δt .

$$K = \frac{L}{V_w}$$

$$NSTPS = \frac{K}{\Delta t} \quad (9-13)$$

where

K = floodwave travel time through the reach

L = channel reach length

V_w = velocity of the floodwave (not average velocity)

$NSTPS$ = number of routing steps

The time interval Δt is usually determined by ensuring that there is a sufficient number of points on the rising side of the inflow hydrograph. A general rule of thumb is that the computation interval should be less than 1/5 of the time of rise (t_r) of the inflow hydrograph.

$$\Delta t \leq \frac{t_r}{5} \quad (9-14)$$

c. *Muskingum method.* The Muskingum method was developed to directly accommodate the looped relationship between storage and outflow that exists in rivers. With the Muskingum method, storage within a reach is visualized in two parts: prism storage and wedge storage. Prism storage is essentially the storage under the steady-flow water surface profile. Wedge storage is the additional storage under the actual water surface profile. As shown in Figure 9-11, during the rising stages of the floodwave the wedge storage is positive and added to the prism storage. During the falling stages of a floodwave, the wedge storage is negative and subtracted from the prism storage.

(1) Development of the Muskingum routing equation.

(a) Prism storage is computed as the outflow (O) times the travel time through the reach (K). Wedge storage is computed as the difference between inflow and outflow ($I-O$) times a weighting coefficient X and the travel time K . The coefficient K corresponds to the travel time of the floodwave through the reach. The parameter X is a dimensionless value expressing a weighting of the relative effects of inflow and outflow on the storage (S) within the reach. Thus, the Muskingum method defines the storage in the reach as a linear function of weighted inflow and outflow:

$S = \text{prism storage} + \text{wedge storage}$

$$S = KO + KX(I-O)$$

$$S = K [XI + (1-X)O] \quad (9-15)$$

where

S = total storage in the routing reach

O = rate of outflow from the routing reach

I = rate of inflow to the routing reach

K = travel time of the floodwave through the reach

X = dimensionless weighting factor, ranging from 0.0 to 0.5

(b) The quantity in the brackets of Equation 9-15 is considered an expression of weighted discharge. When $X = 0.0$, the equation reduces to $S = KO$, indicating that storage is only a function of outflow, which is equivalent to level-pool reservoir routing with storage as a linear function of outflow. When $X = 0.5$, equal weight is given to inflow and outflow, and the condition is equivalent to a uniformly progressive wave that does not attenuate. Thus, "0.0" and "0.5" are limits on the value of X , and within this range the value of X determines the degree of attenuation of the floodwave as it passes through the routing

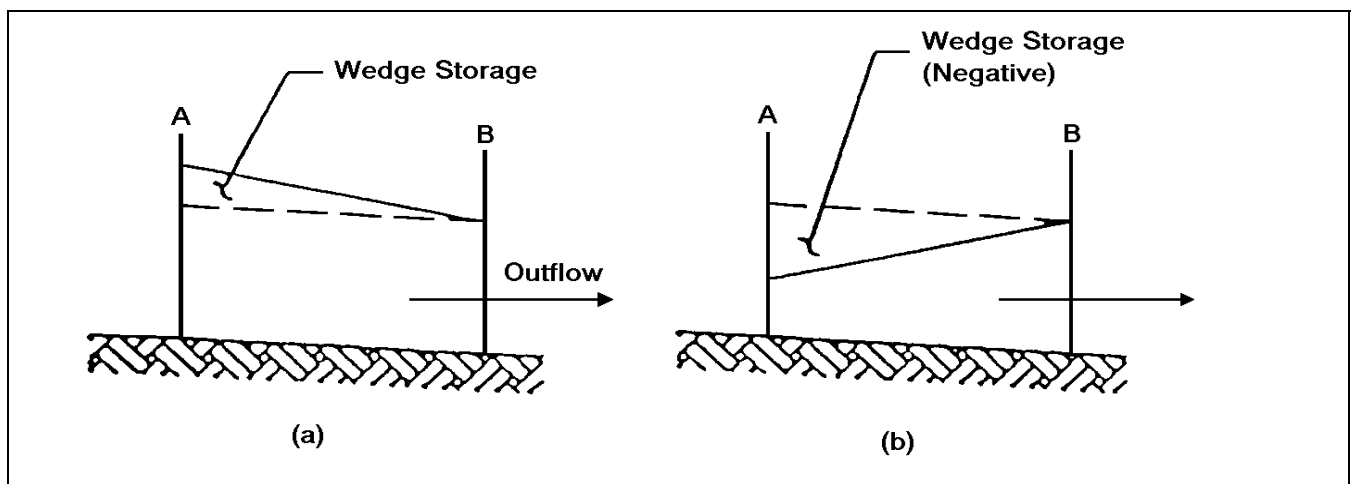

Figure 9-11. Muskingum prism and wedge storage concept

reach. A value of "0.0" produces maximum attenuation, and "0.5" produces pure translation with no attenuation.

(c) The Muskingum routing equation is obtained by combining Equation 9-15 with the continuity equation, Equation 9-11, and solving for O_2 .

$$O_2 = C_1 I_2 + C_2 I_1 + C_3 O_1 \quad (9-16)$$

The subscripts 1 and 2 in this equation indicate the beginning and end, respectively, of a time interval Δt . The routing coefficients C_1 , C_2 , and C_3 are defined in terms of Δt , K , and X .

$$C_1 = \frac{\Delta t - 2KX}{2K(1 - X) + \Delta t} \quad (9-17)$$

$$C_2 = \frac{\Delta t + 2KX}{2K(1 - X) + \Delta t} \quad (9-18)$$

$$C_3 = \frac{2K(1 - X) - \Delta t}{2K(1 - X) + \Delta t} \quad (9-19)$$

Given an inflow hydrograph, a selected computation interval Δt , and estimates for the parameters K and X , the outflow hydrograph can be calculated.

(2) Determination of Muskingum K and X . In a gauged situation, the Muskingum K and X parameters can be calculated from observed inflow and outflow hydrographs. The travel time, K , can be estimated as the interval between similar points on the inflow and outflow hydrographs. The travel time of the routing reach can be calculated as the elapsed time between centroid of areas of the two hydrographs, between the hydrograph peaks, or between midpoints of the rising limbs. After K has been estimated, a value for X can be obtained through trial and error. Assume a value for X , and then route the inflow hydrograph with these parameters. Compare the routed hydrograph with the observed outflow hydrograph. Make adjustments to X to obtain the desired fit. Adjustments to the original estimate of K may also be necessary to obtain the best overall fit between computed and observed hydrographs. In an ungauged situation, a value for K can be estimated as the travel time of the floodwave through the routing reach. The floodwave velocity (V_w) is greater than the average velocity at a given cross section for a given discharge. The floodwave velocity can be estimated by a number of different techniques:

(a) Using Seddon's law, a floodwave velocity can be approximated from the discharge rating curve at a station whose cross section is representative of the routing reach. The slope of the discharge rating curve is equal to dQ/dy . The floodwave velocity, and therefore the travel time K , can be estimated as follows:

$$V_w = \frac{1}{B} \frac{dQ}{dy} \quad (9-20)$$

$$K = \frac{L}{V_w} \quad (9-21)$$

where

V_w = floodwave velocity, in feet/second

B = top width of the water surface

L = length of the routing reach, in feet

(b) Another means of estimating floodwave velocity is to estimate the average velocity (V) and multiply it by a ratio. The average velocity can be calculated from Manning's equation with a representative discharge and cross section for the routing reach. For various channel shapes, the floodwave velocity has been found to be a direct ratio of the average velocity.

<u>Channel shape</u>	<u>Ratio V_w/V</u>
Wide rectangular	1.67
Wide parabolic	1.44
Triangular	1.33

For natural channels, an average ratio of 1.5 is suggested. Once the wave speed has been estimated, the travel time (K) can be calculated with Equation 9-21.

(c) Estimating the Muskingum X parameter in an ungauged situation can be very difficult. X varies between 0.0 and 0.5, with 0.0 providing the maximum amount of hydrograph attenuation and 0.5 no attenuation. Experience has shown that for channels with mild slopes and flows that go out of bank, X will be closer to 0.0. For steeper streams, with well defined channels that do not have flows going out of bank, X will be closer to 0.5. Most natural channels lie somewhere in between these two limits, leaving a lot of room for "engineering judgment." One equation that can be used to estimate the Muskingum X coefficient in ungauged areas has been

developed by Cunge (1969). This equation is taken from the Muskingum-Cunge channel routing method, which is described in paragraph 9-3e. The equation is written as follows:

$$X = \frac{1}{2} \left(1 - \frac{Q_o}{BS_o c \Delta x} \right) \quad (9-22)$$

where

Q_o = reference flow from the inflow hydrograph

c = floodwave speed

S_o = friction slope or bed slope

B = top width of the flow area

Δx = length of the routing subreach

The choice of which flow rate to use in this equation is not completely clear. Experience has shown that a reference flow based on average values (midway between the base flow and the peak flow) is in general the most suitable choice. Reference flows based on peak flow values tend to accelerate the wave much more than it would in nature, while the converse is true if base flow reference values are used (Ponce 1983).

(3) Selection of the number of subreaches. The Muskingum equation has a constraint related to the relationship between the parameter K and the computation interval Δt . Ideally, the two should be equal, but Δt should not be less than $2KX$ to avoid negative coefficients and instabilities in the routing procedure.

$$2KX < \Delta t \leq K \quad (9-23)$$

A long routing reach should be subdivided into subreaches so that the travel time through each subreach is approximately equal to the routing interval Δt . That is:

$$\text{Number of subreaches} = \frac{K}{\Delta t}$$

This assumes that factors such as channel geometry and roughness have been taken into consideration in determining the length of the routing reach and the travel time K .

d. Working R&D routing procedure. The Working R&D procedure is a storage routing technique that accommodates the nonlinear nature of floodwave movement in natural channels. The method is useful in situations where the use of a variable K (reach travel time) would assist in obtaining accurate answers. A nonlinear storage-outflow relationship indicates that a variable K is necessary. The method is also useful in situations wherein the horizontal reservoir surface assumption of the modified puls procedure is not applicable, such as normally occurs in natural channels.

(1) The working R&D procedure could be termed "Muskingum with a variable K " or "modified puls with wedge storage." For a straight line storage-discharge (weighted discharge) relation, the procedure is the same solution as the Muskingum method. For $X = 0$, the procedure is identical to Modified Puls.

(2) The basis for the procedure derives from the concept of a "working discharge," which is a hypothetical steady flow that would result in the same natural channel storage that occurs with the passage of a floodwave. Figure 9-12 illustrates this concept.

where

I = reach inflow

O = reach outflow

D = working value discharge or simply working discharge

(3) The wedge storage (WS) may be computed in the following two ways: As in the Muskingum technique where X is a weighting factor and K is reach travel time:

$$WS = KX (I-O) \quad (9-24)$$

or using the working discharge (D) concept:

$$WS = K (D-O) \quad (9-25)$$

equating and solving for O :

$$K (D-O) = KX (I-O) \quad (9-26)$$

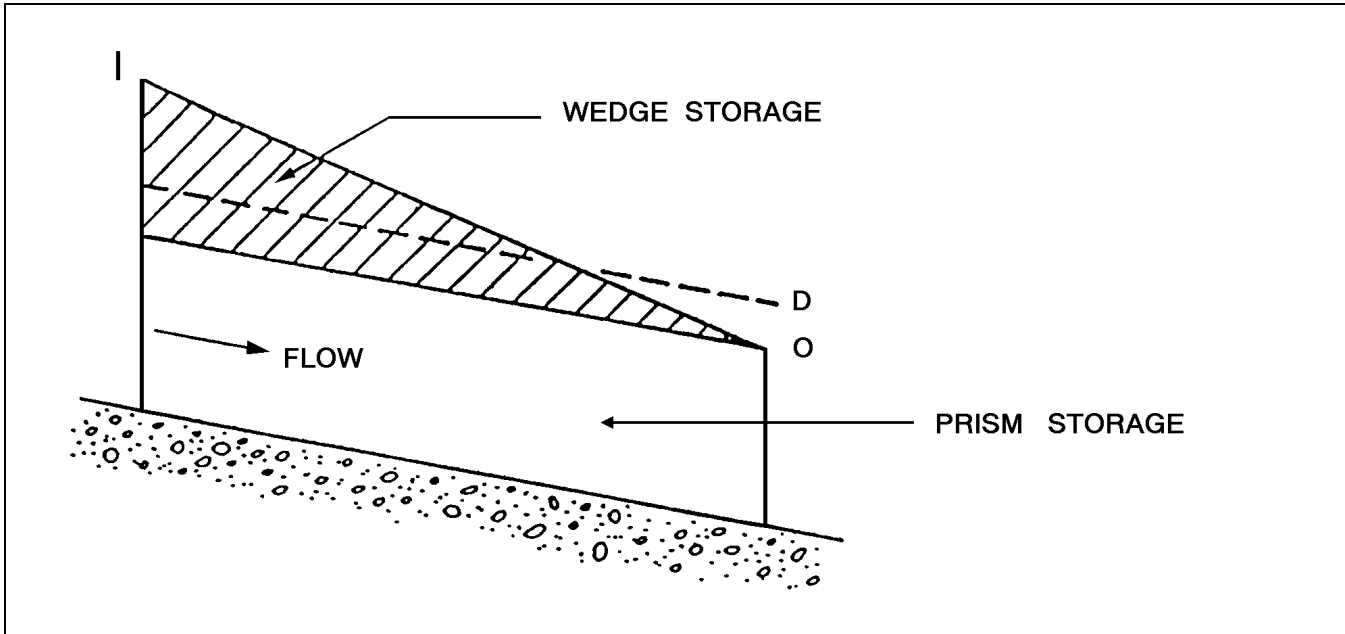

Figure 9-12. Illustration of the “working discharge” concept

or

$$O = D - \frac{X}{1-X} (I-D) \quad (9-27)$$

The continuity equation may be approximated by:

$$\frac{S_2 - S_1}{\Delta t} = 0.5 (I_1 + I_2) - 0.5 (O_1 + O_2) \quad (9-28)$$

where

S = storage

Δt = time increment

Substituting Equation 9-27 into 9-28 and appending the appropriate subscripts to denote beginning and end of period and performing the appropriate algebra yields:

$$\begin{aligned} &0.5\Delta t(I_1 + I_2) + [S_1(1 - X) - 0.5D_1\Delta t] \\ &= [S_2(1 - X) + 0.5D_2\Delta t] \end{aligned} \quad (9-29)$$

Let

$$R = S (1 - X) + 0.5D\Delta t \quad (9-30)$$

where R is termed the “working value of storage” or simply working storage and represents an index of the true natural storage. Equation 9-29 may therefore be written:

$$R_2 = R_1 + 0.5\Delta t (I_1 + I_2) - D_1\Delta t \quad (9-31)$$

transposing Δt results in the equation used in routing computations:

$$\frac{R_2}{\Delta t} = \frac{R_1}{\Delta t} + 0.5 (I_1 + I_2) - D_1 \quad (9-32)$$

The form of the relationship for R (working discharge) is analogous to storage indication in the modified puls procedure. $R_2/\Delta t$ may be computed from information known at the beginning of a routing interval. The outflow at the end of the routing interval may then be determined from a

rating curve of working storage versus working discharge. The cycle is then repeated stepping forward in time.

(4) The solution scheme using this concept requires development of a rating curve of working storage versus working discharge as stated above. The following column headings are helpful in developing the function when storage-outflow data are available.

1	2	3
Storage (S)	$\frac{S}{\Delta t} (1-X)$	Working Discharge (D)
4	5	
$\frac{D}{2}$	$\frac{S}{\Delta t} (1-X) + \frac{D}{2}$	

(5) Column 2 of the tabulation is obtained from column 1 by using an appropriate conversion factor and appropriate X. The conversion factor of 1 acre-ft/hour = 12.1 cfs is useful in this regard. Column 5 is the sum of columns 2 and 4. Column 3 is plotted against column 5 on cartesian coordinate paper and a curve drawn through the plotted points. This represents the working discharge-working outflow rating curve. An example curve is shown in Figure 9-13.

(6) The routing of a hydrograph can be performed as the one shown in Table 9-2. The procedure, in narrative form is:

- Conditions known at time 1: I_1 , O_1 , D_1 , and $R_1/\Delta t$.
- At time 2, only I_2 is known, therefore:

$$\frac{R_2}{\Delta t} = \frac{R_1}{\Delta t} + 0.5 (I_1 + I_2) - D_1$$

- Enter working storage, working discharge function, and read out D_2 .
- Calculate O_2 as follows:

$$O_2 = D_2 - \frac{X}{1-X} (I_2 - D_2)$$

- Repeat process until finished.

e. Muskingum-Cunge channel routing. The Muskingum-Cunge channel routing technique is a nonlinear coefficient method that accounts for hydrograph diffusion based on physical channel properties and the inflowing hydrograph. The advantages of this method over other hydrologic techniques are the parameters of the model are more physically based; the method has been shown to compare well against the full unsteady flow equations over a wide range of flow situations (Ponce 1983 and Brunner 1989); and the solution is independent of the user-specified computation interval. The major limitations of the Muskingum-Cunge technique are that it cannot account for backwater effects, and the method begins to diverge from the full unsteady flow solution when very rapidly rising hydrographs are routed through flat channel sections.

- (1) Development of equations.

(a) The basic formulation of the equations is derived from the continuity Equation 9-33 and the diffusion form of the momentum Equation 9-34:

$$\frac{\partial A}{\partial t} + \frac{\partial Q}{\partial x} = q_t \quad (9-33)$$

$$S_f = S_o - \frac{\partial Y}{\partial x} \quad (9-34)$$

(b) By combining Equations 9-33 and 9-34 and linearizing, the following convective diffusion equation is formulated (Miller and Cunge 1975):

$$\frac{\partial Q}{\partial t} + c \frac{\partial Q}{\partial x} = \mu \frac{\partial^2 Q}{\partial x^2} + c q_L \quad (9-35)$$

where

Q = discharge, in cubic feet per second

A = flow area, in square feet

t = time, in seconds

x = distance along the channel, in feet

Y = depth of flow, in feet

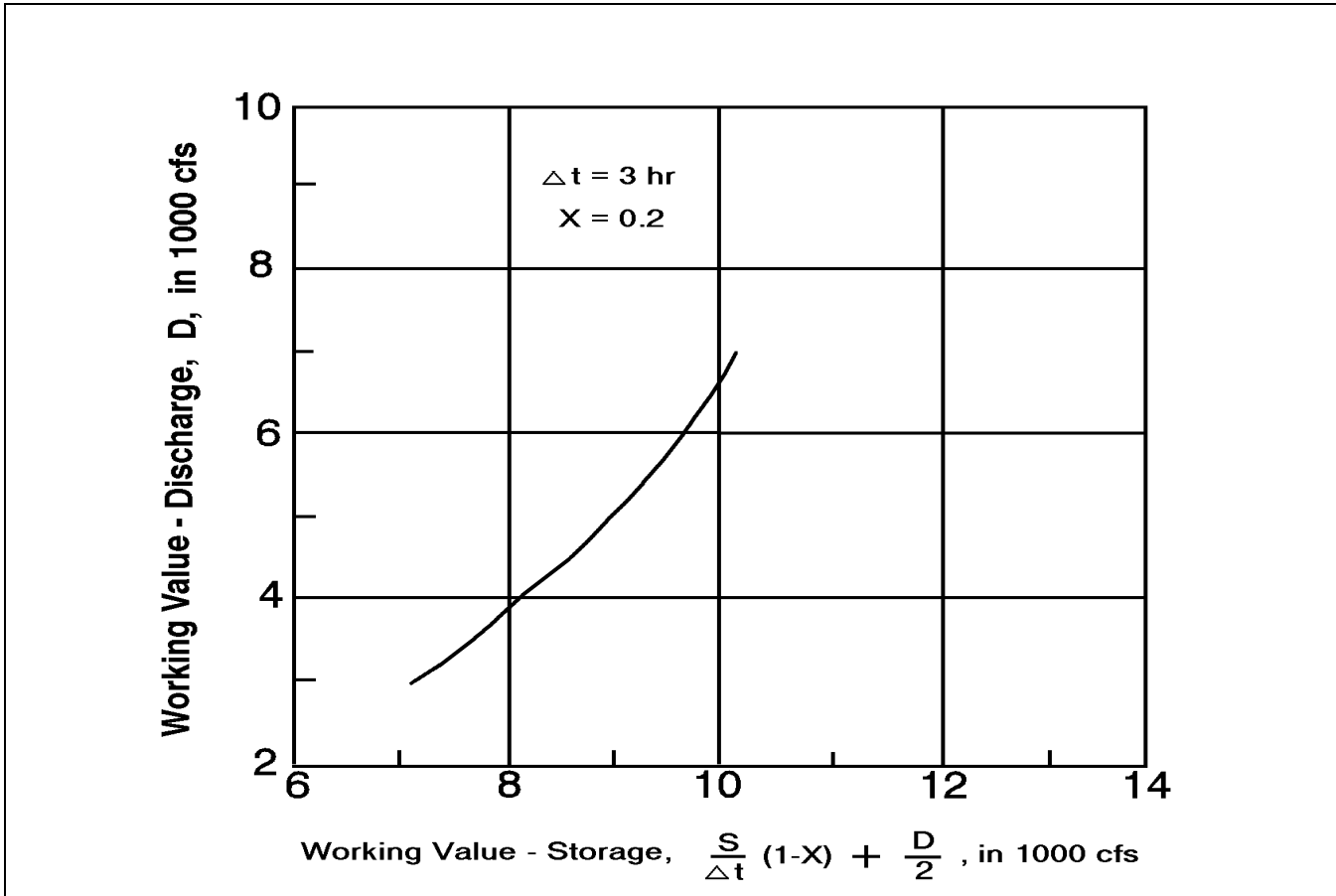

Figure 9-13. Rating curve for working R&D routing

- q_L = lateral inflow per unit of channel length
- S_f = friction slope
- S_o = bed slope
- c = the wave celerity in the x direction as defined below

The wave celerity (c) and the hydraulic diffusivity (μ) are expressed as follows:

$$c = \frac{dQ}{dA} \quad (9-36)$$

$$\mu = \frac{Q}{2BS_o} \quad (9-37)$$

where B is the top width of the water surface. The convective diffusion Equation 9-35 is the basis for the Muskingum-Cunge method.

(c) In the original Muskingum formulation, with lateral inflow, the continuity Equation 9-33) is discretized on the x-t plane (Figure 9-14) to yield:

$$Q_{j-1}^{n-1} = C_1 Q_j^n + C_2 Q_j^{n-1} + C_3 Q_{j-1}^n + C_4 Q_L \quad (9-38)$$

It is assumed that the storage in the reach is expressed as the classical Muskingum storage:

$$S = K [XI + (1-X)O] \quad (9-39)$$

Table 9-2
Working R&D Routing Example

Time hr	Inflow cfs	Average Inflow cfs	$\frac{K}{\Delta t} + 0.5(I_1 + I_2) - D_1$ cfs	D cfs	O cfs
	3,000		7,100	3,000	3,000
		3,130			
3	3,260		7,230	3,100	3,060
		3,445			
6	3,630		7,575	3,300	3,220
		3,825			
9	4,020		8,100	3,800	3,745
		4,250			
12	4,480		8,550	4,400	4,420

where

S = channel storage

K = cell travel time (seconds)

X = weighting factor

I = inflow

O = outflow

Therefore, the coefficients can be expressed as follows:

$$C_1 = \frac{\frac{\Delta t}{K} + 2X}{\frac{\Delta t}{K} + 2(1 - X)}$$

$$C_2 = \frac{\frac{\Delta t}{K} - 2X}{\frac{\Delta t}{K} + 2(1 - X)}$$

$$C_3 = \frac{2(1 - X) - \frac{\Delta t}{K}}{\frac{\Delta t}{K} + 2(1 - X)}$$

$$Q_L = q_L \Delta X$$

$$C_4 = \frac{2\left(\frac{\Delta t}{K}\right)}{\frac{\Delta t}{K} + 2(1 - X)}$$

(d) In the Muskingum equation the amount of diffusion is based on the value of X , which varies between 0.0 and 0.5. The Muskingum X parameter is not directly related to physical channel properties. The diffusion obtained with the Muskingum technique is a function of how the equation is solved and is therefore considered numerical diffusion rather than physical. Cunge evaluated the diffusion that is produced in the Muskingum equation and analytically solved for the following diffusion coefficient:

$$\mu_n = c \Delta x \left(\frac{1}{2} - X \right) \quad (9-40)$$

In the Muskingum-Cunge formulation, the amount of diffusion is controlled by forcing the numerical diffusion to match the physical diffusion of the convective diffusion Equation 9-35. This is accomplished by setting Equations 9-37 and 9-40 equal to each other. The Muskingum-Cunge equation is therefore considered an approximation of the convective diffusion Equation 9-35. As a result, the parameters K and X are expressed as follows (Cunge 1969 and Ponce and Yevjevich 1978):

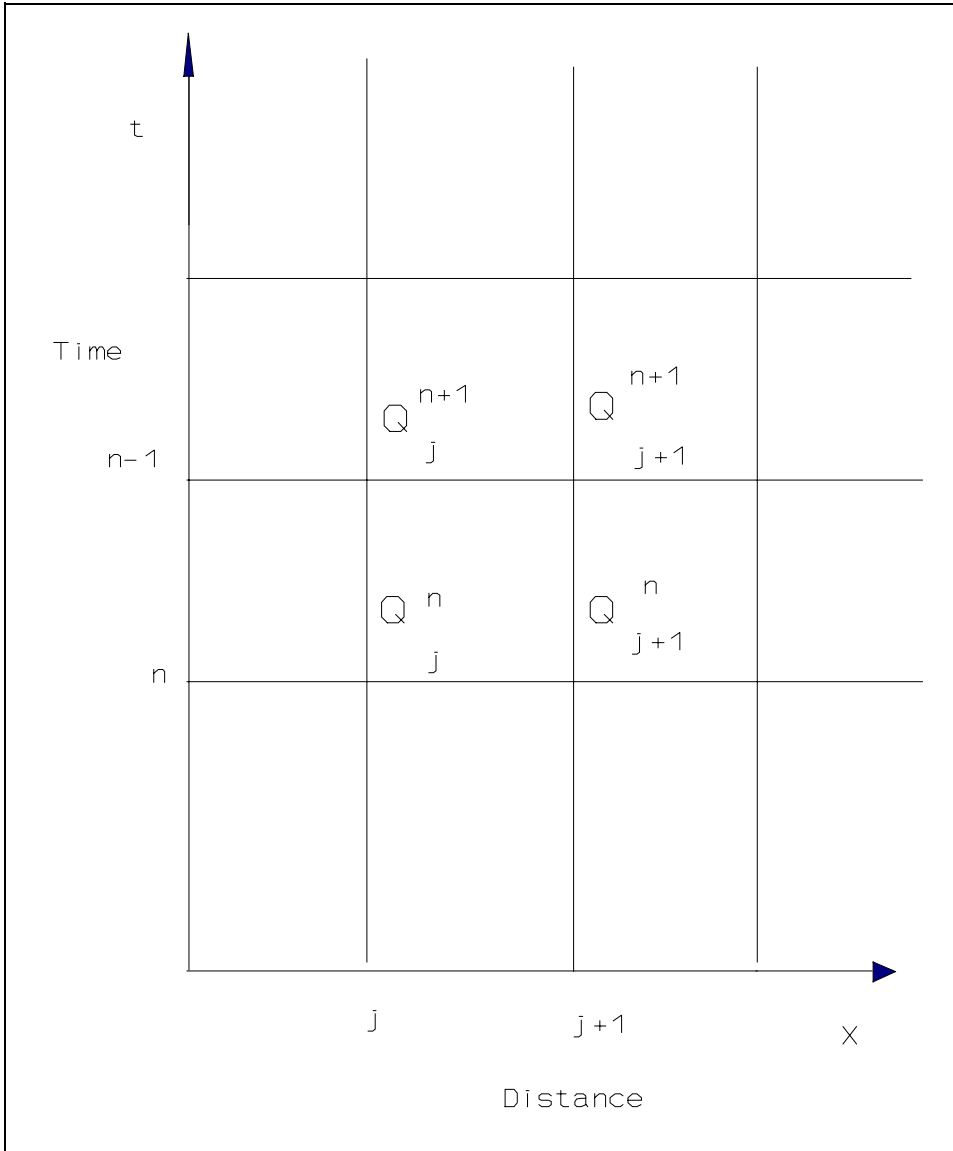

Figure 9-14. Discretization of the continuity equation on x-t plane

$$K = \frac{\Delta X}{c} \quad (9-41)$$

averaging scheme is used to solve for c , B , and Q . This process has been described in detail by Ponce (1986).

$$X = \frac{1}{2} \left(1 - \frac{Q}{BS_o c \Delta x} \right) \quad (9-42)$$

(b) Values for Δt and Δx are chosen for accuracy and stability. First, Δt should be evaluated by looking at the following three criteria and selecting the smallest value: (1) the user-defined computation interval, (2) the time of rise of the inflow hydrograph divided by 20 ($T_{r/20}$), and (3) the travel time through the channel reach. Once Δt is chosen, Δx is defined as follows:

$$\Delta x = c \Delta t \quad (9-43)$$

(2) Solution of the equations.

(a) The method is nonlinear in that the flow hydraulics (Q , B , c), and therefore the routing coefficients (C_1 , C_2 , C_3 , and C_4) are recalculated for every Δx distance step and Δt time step. An iterative four-point

but Δx must also meet the following criteria to preserve consistency in the method (Ponce 1983):

$$\Delta x < \frac{1}{2} \left(c\Delta t + \frac{Q_o}{BS_o c} \right) \quad (9-44)$$

where Q_o is the reference flow and Q_B is the baseflow taken from the inflow hydrograph as:

$$Q_o = Q_B + 0.50 (Q_{peak} - Q_B)$$

(3) Data requirements.

(a) Data for the Muskingum-Cunge method consist of the following:

- Representative channel cross section.
- Reach length, L .
- Manning roughness coefficients, n (for main channel and overbanks).
- Friction slope (S_f) or channel bed slope (S_o).

(b) The method can be used with a simple cross section (i.e., trapezoid, rectangle, square, triangle, or circular pipe) or a more detailed cross section (i.e., cross sections with a left overbank, main channel, and a right overbank). The cross section is assumed to be representative of the entire routing reach. If this assumption is not adequate, the routing reach should be broken up into smaller sub-reaches with representative cross sections for each. Reach lengths are measured directly from topographic maps. Roughness coefficients (Manning's n) must be estimated for main channels as well as overbank areas. If information is available to estimate an approximate energy grade line slope (friction slope, S_f), that slope should be used instead of the bed slope. If no information is available to estimate the slope of the energy grade line, the channel bed slope should be used.

(4) Advantages and limitations. The Muskingum-Cunge routing technique is considered to be a nonlinear coefficient method that accounts for hydrograph diffusion based on physical channel properties and the inflowing hydrograph. The advantages of this method over other hydrologic techniques are: the parameters of the model are physically based, and therefore this method will make for a good ungauged routing technique; several studies have shown that the method compares very well with the

full unsteady flow equations over a wide range of flow conditions (Ponce 1983 and Brunner 1989); and the solution is independent of the user-specified computation interval. The major limitations of the Muskingum-Cunge technique are that the method can not account for backwater effects, and the method begins to diverge from the complete unsteady flow solution when very rapidly rising hydrographs (i.e., less than 2 hr) are routed through flat channel sections (i.e., channel slopes less than 1 ft/mile). For hydrographs with longer rise times (T_r), the method can be used for channel reaches with slopes less than 1 ft/mile.

9-4. Applicability of Routing Techniques

a. Selecting the appropriate routing method. With such a wide range of hydraulic and hydrologic routing techniques, selecting the appropriate routing method for each specific problem is not clearly defined. However, certain thought processes and some general guidelines can be used to narrow the choices, and ultimately the selection of an appropriate method can be made.

b. Hydrologic routing method. Typically, in rainfall-runoff analyses, hydrologic routing procedures are utilized on a reach-by-reach basis from upstream to downstream. In general, the main goal of the rainfall-runoff study is to calculate discharge hydrographs at several locations in the watershed. In the absence of significant backwater effects, the hydrologic routing models offer the advantages of simplicity, ease of use, and computational efficiency. Also, the accuracy of hydrologic methods in calculating discharge hydrographs is normally well within the range of acceptable values. It should be remembered, however, that insignificant backwater effects alone do not always justify the use of a hydrologic method. There are many other factors that must be considered when deciding if a hydrologic model will be appropriate, or if it is necessary to use a more detailed hydraulic model.

c. Hydraulic routing method. The full unsteady flow equations have the capability to simulate the widest range of flow situations and channel characteristics. Hydraulic models, in general, are more physically based since they only have one parameter (the roughness coefficient) to estimate or calibrate. Roughness coefficients can be estimated with some degree of accuracy from inspection of the waterway, which makes the hydraulic methods more applicable to ungauged situations.

d. Evaluating the routing method. There are several factors that should be considered when evaluating which routing method is the most appropriate for a given

situation. The following is a list of the major factors that should be considered in this selection process:

(1) Backwater effects. Backwater effects can be produced by tidal fluctuations, significant tributary inflows, dams, bridges, culverts, and channel constrictions. A floodwave that is subjected to the influences of backwater will be attenuated and delayed in time. Of the hydrologic methods discussed previously, only the modified puls method is capable of incorporating the effects of backwater into the solution. This is accomplished by calculating a storage-discharge relationship that has the effects of backwater included in the relationship. Storage-discharge relationships can be determined from steady flow-water surface profile calculations, observed water surface profiles, normal depth calculations, and observed inflow and outflow hydrographs. All of these techniques, except the normal depth calculations, are capable of including the effects of backwater into the storage-discharge relationship. Of the hydraulic methods discussed in this chapter, only the kinematic wave technique is not capable of accounting for the influences of backwater on the floodwave. This is due to the fact that the kinematic wave equations are based on uniform flow assumptions and a normal depth downstream boundary condition.

(2) Floodplains. When the flood hydrograph reaches a magnitude that is greater than the channels carrying capacity, water flows out into the overbank areas. Depending on the characteristics of the overbanks, the flow can be slowed greatly, and often ponding of water can occur. The effects of the floodplains on the floodwave can be very significant. The factors that are important in evaluating to what extent the floodplain will impact the hydrograph are the width of the floodplain, the slope of the floodplain in the lateral direction, and the resistance to flow due to vegetation in the floodplain. To analyze the transition from main channel to overbank flows, the modeling technique must account for varying conveyance between the main channel and the overbank areas. For 1-D flow models, this is normally accomplished by calculating the hydraulic properties of the main channel and the overbank areas separately, then combining them to formulate a composite set of hydraulic relationships. This can be accomplished in all of the routing methods discussed previously except for the Muskingum method. The Muskingum method is a linear routing technique that uses coefficients to account for hydrograph timing and diffusion. These coefficients are usually held constant during the routing of a given floodwave. While these coefficients can be calibrated to match the peak flow and timing of a specific flood magnitude, they can not be used to model a range of floods that may remain in

bank or go out of bank. When modeling floods through extremely flat and wide floodplains, the assumption of 1-D flow in itself may be inadequate. For this flow condition, velocities in the lateral direction (across the floodplain) may be just as predominant as those in the longitudinal direction (down the channel). When this occurs, a two-dimensional (2-D) flow model would give a more accurate representation of the physical processes. This subject is beyond the scope of this chapter. For more information on this topic, the reader is referred to EM 1110-2-1416.

(3) Channel slope and hydrograph characteristics. The slope of the channel will not only affect the velocity of the floodwave, but it can also affect the amount of attenuation that will occur during the routing process. Steep channel slopes accelerate the floodwave, while mild channel slopes are prone to slower velocities and greater amounts of hydrograph attenuation. Of all the routing methods presented in this chapter, only the complete unsteady flow equations are capable of routing floodwaves through channels that range from steep to extremely flat slopes. As the channel slopes become flatter, many of the methods begin to break down. For the simplified hydraulic methods, the terms in the momentum equation that were excluded become more important in magnitude as the channel slope is decreased. Because of this, the range of applicable channel slopes decreases with the number of terms excluded from the momentum equation. As a rule of thumb, the kinematic wave equations should only be applied to relatively steep channels (10 ft/mile or greater). Since the diffusion wave approximation includes the pressure differential term in the momentum equation, it is applicable to a wider range of slopes than the kinematic wave equations. The diffusion wave technique can be used to route slow rising floodwaves through extremely flat slopes. However, rapidly rising floodwaves should be limited to mild to steep channel slopes (approximately 1 ft/mile or greater). This limitation is due to the fact that the acceleration terms in the momentum equation increase in magnitude as the time of rise of the inflowing hydrograph is decreased. Since the diffusion wave method does not include these acceleration terms, routing rapidly rising hydrographs through flat channel slopes can result in errors in the amount of diffusion that will occur. While "rules of thumb" for channel slopes can be established, it should be realized that it is the combination of channel slope and the time of rise of the inflow hydrograph together that will determine if a method is applicable or not.

(a) Ponce and Yevjevich (1978) established a numerical criteria for the applicability of hydraulic routing

techniques. According to Ponce, the error due to the use of the kinematic wave model (error in hydrograph peak accumulated after an elapsed time equal to the hydrograph duration) is within 5 percent, provided the following inequality is satisfied:

$$\frac{TS_o u_o}{d_o} \geq 171 \quad (9-45)$$

where

T = hydrograph duration, in seconds

S_o = friction slope or bed slope

u_o = reference mean velocity

d_o = reference flow depth

When applying Equation 9-45 to check the validity of using the kinematic wave model, the reference values should correspond as closely as possible to the average flow conditions of the hydrograph to be routed.

(b) The error due to the use of the diffusion wave model is within 5 percent, provided the following inequality is satisfied:

$$TS_o \left(\frac{g}{d_o} \right)^{1/2} \geq 30 \quad (9-46)$$

where g = acceleration of gravity. For instance, assume $S_o = 0.001$, $u_o = 3$ ft/s, and $d_o = 10$ ft. The kinematic wave model will apply for hydrographs of duration larger than 6.59 days. Likewise, the diffusion wave model will apply for hydrographs of duration larger than 0.19 days.

(c) Of the hydrologic methods, the Muskingum-Cunge method is applicable to the widest range of channel slopes and inflowing hydrographs. This is due to the fact that the Muskingum-Cunge technique is an approximation of the diffusion wave equations, and therefore can be applied to channel slopes of a similar range in magnitude. The other hydrologic techniques use an approximate relationship in place of the momentum equation. Experience has shown that these techniques should not be applied to channels with slopes less than 2 ft/mi. However, if there is gauged data available, some of the parameters of the hydrologic methods can be calibrated to produce the desired attenuation effects that occur in very flat streams.

(4) Flow networks. In a dendritic stream system, if the tributary flows or the main channel flows do not cause significant backwater at the confluence of the two streams, any of the hydraulic or hydrologic routing methods can be applied. If significant backwater does occur at the confluence of two streams, then the hydraulic methods that can account for backwater (full unsteady flow and diffusion wave) should be applied. For full networks, where the flow divides and possibly changes direction during the event, only the full unsteady flow equations and the diffusion wave equations can be applied.

(5) Subcritical and supercritical flow. During a flood event, a stream may experience transitions between subcritical and supercritical flow regimes. If the supercritical flow reaches are long, or if it is important to calculate an accurate stage within the supercritical reach, the transitions between subcritical and supercritical flow should be treated as internal boundary conditions and the supercritical flow reach as a separate routing section. This is normally accomplished with hydraulic routing methods that have specific routines to handle supercritical flow. In general, none of the hydrologic methods have knowledge about the flow regime (supercritical or subcritical), since hydrologic methods are only concerned with flows and not stages. If the supercritical flow reaches are short, they will not have a noticeable impact on the discharge hydrograph. Therefore, when it is only important to calculate the discharge hydrograph, and not stages, hydrologic routing methods can be used for reaches with small sections of supercritical flow.

(6) Observed data. In general, if observed data are not available, the routing methods that are more physically based are preferred and will be easier to apply. When gauged data are available, all of the methods should be calibrated to match observed flows and/or stages as best as possible. The hydraulic methods, as well as the Muskingum-Cunge technique, are considered physically based in the sense that they only have one parameter (roughness coefficient) that must be estimated or calibrated. The other hydrologic methods may have more than one parameter to be estimated or calibrated. Many of these parameters, such as the Muskingum X and the number of subreaches (NSTPS), are not related directly to physical aspects of the channel and inflowing hydrograph. Because of this, these methods are generally not used in ungauged situations. The final choice of a routing model is also influenced by other factors, such as the required accuracy, the type and availability of data, the type of information desired (flow hydrographs, stages, velocities, etc.), and the familiarity and experience of the user with a given method. The modeler must take all of these factors

into consideration when selecting an appropriate routing technique for a specific problem. Table 9-3 contains a list of some of the factors discussed previously, along with some guidance as to which routing methods are

appropriate and which are not. This table should be used as guidance in selecting an appropriate method for routing discharge hydrographs. By no means is this table all inclusive.

Table 9-3
Selecting the Appropriate Channel Routing Technique

Factors to consider in the selection of a routing technique.	Methods that are appropriate for this specific factor.	Methods that are not appropriate for this factor.
1. No observed hydrograph data available for calibration.	* Full Dynamic Wave * Diffusion Wave * Kinematic Wave * Muskingum-Cunge	* Modified Puls * Muskingum * Working R&D
2. Significant backwater that will influence discharge hydrograph.	* Full Dynamic Wave * Diffusion Wave * Modified Puls * Working R&D	* Kinematic Wave * Muskingum * Muskingum-Cunge
3. Flood wave will go out of bank into the flood plains.	* All hydraulic and hydrologic methods that calculate hydraulic properties of main channel separate from overbanks.	* Muskingum
4. Channel slope > 10 ft/mile $\frac{TS_o u_o}{d_o} \geq 171$ and	* All methods presented	* None
5. Channel slopes from 10 to 2 ft/mile and $\frac{TS_o u_o}{d_o} < 171$	* Full Dynamic Wave * Diffusion Wave * Muskingum-Cunge * Modified Puls * Muskingum * Working R&D	* Kinematic Wave
6. Channel slope < 2 ft/mile and $TS_o \left(\frac{g}{d_o} \right)^{1/2} \geq 30$	* Full Dynamic Wave * Diffusion Wave * Muskingum-Cunge	* Kinematic Wave * Modified Puls * Muskingum * Working R&D
7. Channel slope < 2 ft/mile and $TS_o \left(\frac{g}{d_o} \right)^{1/2} < 30$	* Full Dynamic Wave	* All others

Chapter 10 Multisubbasin Modeling

10-1. General

a. The foregoing chapters have described the various components of the watershed-runoff process. This chapter describes how these components are combined into a river basin model, as shown in Figure 10-1. The components can be thought of as building blocks for a comprehensive river basin analysis model or detailed pieces of a smaller watershed model. Those components may include small, component watersheds (subbasins) which are integral pieces of the larger basin; river reaches which connect the subbasins; confluences of rivers; lakes; and various man-made features. There are many man-made features in a river basin which affect the rate and volume of runoff. Some of the main features are reservoirs, urbanization, diversions, channel improvements, levees, and pumps. The multisubbasin model refers to the collection of all these natural and man-made components which describe the runoff process in a river basin.

b. This chapter describes the components of a river basin and provides criteria for subdividing basins into these components. Once the river basin model is built, it too must be calibrated and verified. Even though each of these components may have been individually calibrated as described in the previous chapters, the whole model must also be calibrated. The synergistic effect of all the components acting together may produce different results than their individual calibrations. This can be due to the spatial variation in precipitation and runoff, and/or nonlinearities in the river routing process. Thus, methods for calibrating and verifying a river basin model are also provided here.

10-2. General Considerations for Selecting Basin Components

a. General considerations for selecting the size and location of basin components are discussed in this paragraph. More detailed hydrologic, hydraulic, and project engineering and management criteria for sizing and locating basin components are given in paragraph 10-3. There are three general considerations for selecting and sizing basin components: where is information needed; where

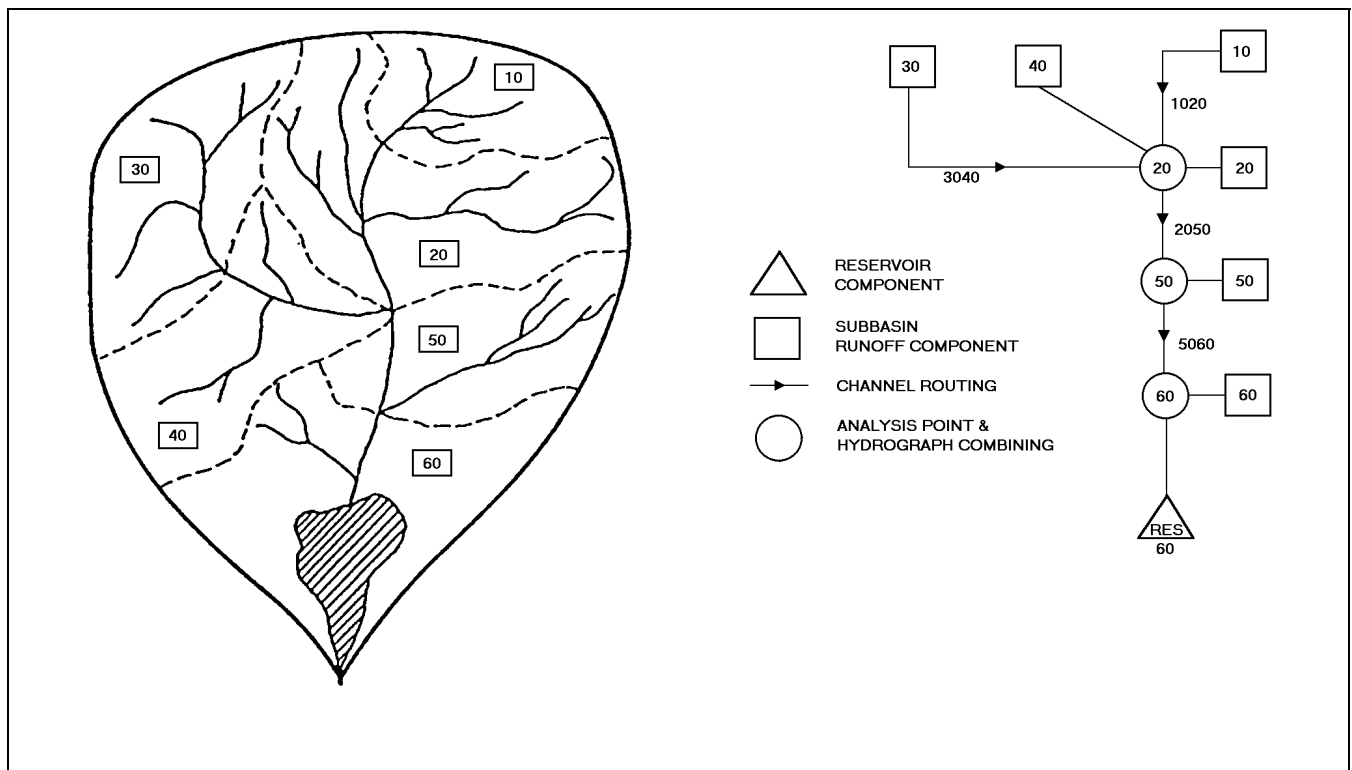

Figure 10-1. Components of a river basin model

are data available; and where do hydrologic/hydraulic conditions change?

b. The first consideration addresses why the analysis is being made. It includes input from all study team members such as economists, engineers, and environmentalists. Typical places where information is needed are locations subject to flood damage, sites where projects are proposed, wetlands, and archeological sites. The entire study team should be involved in identifying these information needs.

c. The second consideration addresses how much information one has to perform the analysis. Data availability is key to successful modeling. Thus, the basin model must be structured to take advantage of available data. Some of the primary types of information which influence basin subdivision are stream gauges, precipitation gauges, river-geometry surveys, and previous studies. By subdividing a river basin at these data locations, the model can be calibrated much more easily.

d. The third consideration addresses where hydrologic and hydraulic processes change so that they can be adequately represented by the basin components. Hydrologic modeling assumes that uniform conditions prevail within each of the basin components. The term "lumped parameter" refers to that condition where the same process is assumed to occur equally over the entire component. Some examples are a watershed with a mixture of urban and rural areas and a river which goes from a narrow canyon into a broad floodplain. One cannot assume that the same hydrologic or hydraulic parameters can describe the runoff process in areas where the physical processes are quite variable. One of the keys to successful hydrologic modeling is to select basin components which are "representative" of the heterogeneous processes of nature.

10-3. Selection of Hydrograph Computation Locations

Subbasins, channel reaches, and confluences are the general locations where hydrographs are computed. Subbasins are usually part of all the other basin component decisions. That is, whenever a computational point is identified in a basin, the local tributary watershed runoff is also computed at that point. For example, the land surface runoff characteristics of a basin may be constant, but the river hydraulic characteristics may change in the middle of that basin. In that case, two subbasins for land surface runoff may be used so that the upstream runoff

can be added to the hydrograph before routing through the downstream reach. Too large a subbasin may "average out" important watershed and river dynamics. Too small a subbasin increases data handling and processing expenses.

a. *Hydrologic criteria.* Variation in precipitation and infiltration are two important hydrologic criteria. A detailed explanation of both criteria follows.

(1) Precipitation variation. The subbasin runoff computation process involves determination of subbasin-average precipitation and infiltration, then transformation of the resulting moisture excess into streamflow at the outlet of the subbasin. Thus, subbasins should be sized to capture variations in precipitation and infiltration. It would be desirable to have a recording precipitation gauge in every subbasin, but usually there are many more subbasins needed than there are precipitation gauges. The main consideration must be that there are enough subbasins to capture the spatial variation in precipitation.

(2) Infiltration variation. Infiltration characteristics of the land surface are a major part of subbasin selection. The desire is to have a subbasin with uniform infiltration characteristics. Thus, forested areas should be separated from grasslands, urban from rural, agricultural from natural, etc. Different soil types also have different infiltration characteristics. The general consideration is land use. Where land use changes, infiltration characteristics change. The problem is that watersheds are not made up of uniform land uses. The objective is to select areas which are "representative" of a particular infiltration condition. This average infiltration consideration becomes especially difficult in urban areas which are inherently a mixture of many land uses. The basic concept is the same: subdivide the watershed into like-watershed responses. The urban case requires consideration of additional features such as:

- (a) presence of storm drains,
- (b) roof downspouts directly connected to the street,
- (c) large parks or shopping centers, and
- (d) local drainage requirements.

Oftentimes these conditions will change with different land developers and city/county ordinances. In the urban case, it is often desirable to compute runoff from pervious and impervious areas separately within the same subbasin.

This procedure allows infiltration characteristics to vary, capturing the two main land-use characteristics in an urban subbasin.

(3) Runoff variation. The land-use condition also determines the rate of runoff. Land slope is also a major factor determining the rate of runoff. These land-use and slope conditions are represented by different unit hydrograph or kinematic wave land surface runoff parameters. Because only one set of parameters may be specified for a subbasin, it is important to have them “representative” of the average subbasin characteristics. Ideally, a subbasin would have similar land use, soils, slope, and stream-network patterns. Urbanization obviously can make drastic changes to the runoff network.

b. Hydraulic criteria. Natural channel variation and man-made variations are two important hydraulic criteria. A detailed explanation of both criteria follows.

(1) Natural channel variation. Hydraulic criteria refer to where the river or stream channel changes in a significant enough manner to affect the routing processes. Examples of these hydraulic controls are constrictions in the channel, major changes in the slope of the channel, broadening of the channel into a floodplain, and confluence with tributaries. Because only a single routing method can be used in a single river reach, that reach should have reasonably uniform hydraulic characteristics. Tributaries are important because many of the river routing processes are nonlinear and depend upon the magnitude of the flow. Thus, where tributaries increase the flow significantly, separate routing reaches should be incorporated upstream and downstream of the tributary.

(2) Man-made variations. Manmade structures and modifications of the river channels usually have a major impact on the flow routing process. Examples of man-made features are bridges, floodplain encroachments, diversions, pumps, dams, weirs, culverts, levees and floodwalls, and channel clearing and cleaning. All of these changes to the natural river system usually have a major impact on the routing process; and thus, channels where these variations occur should be modeled separately.

c. Information needs criteria. Information needs are dependent on the purpose of the project. If flood damage reduction is a project purpose, then flood damage locations (cities, towns, industrial sites, etc.) must be included as a hydrograph computation point. Such points do not enhance the hydrologic/hydraulic computations, but they are necessary to provide the flow and stage

information for computing flood damage. The same is true for any other project purpose which depends on river flow/stage for its evaluation.

d. Data availability criteria. Data are necessary to calibrate the river basin model to observed historical events. Data are usually insufficient, so every gauge location must be carefully reviewed and used to the fullest extent possible. Stage or flow gauging stations are the most important for determining hydrograph computation points.

(1) A subbasin/river reach break point will usually be made at every stream gauge so that the computed hydrograph can be compared with the observed hydrograph at that location.

(2) Sometimes special river basin subdivisions will be made differently than the general river basin model to make use of the data for calibration of subbasin runoff parameters. That is, the total area contributing to a gauge may be used as a single subbasin for the purposes of calibrating watershed runoff parameters to different sized basin areas. Those special, large basins are only used for the subbasin parameter calibration and regionalization needs; those large subbasins are disaggregated back into their logical components for the generalized river basin model.

e. General criteria.

(1) These considerations must also take into account the practical engineering economy of the analysis and the purpose for which the study is being made. There is always a tradeoff between a detailed representation of a river basin and the practical information needs and resources available for the study. For instance, the surcharging of a culvert may be critical to local information needs in an urban area, but it may have very little effect on the peak discharge farther downstream in a large river basin. Thus, the watershed modeler’s job is to weigh these information needs against the watershed and river dynamics to obtain a representation of the basin which provides the needed information within a reasonable cost and time.

(2) The river basin modeler should be careful to include all major components in the river basin model. That is, do not lump together too large of an area just because data are not available for a particular area of the river basin. A logical physical network of subbasins and river reaches should still be maintained even though data are not available. One example is to treat major

tributaries as separate components rather than lump them in with the local tributary area of the main river. Building a logical basin model will help identify where additional data are needed, and then it will be ready to include the data when available.

10-4. Calibration of Individual Components

The first step in the calibration of the river basin model is the calibration of the individual components where observed precipitation runoff data are available; such as, calibration of the subbasin infiltration, runoff transformation, base-flow parameters, and calibration of the river reach flood routing parameters, as described in the preceding chapters. Obviously, not all of the subbasins and routing reaches in the river basin will have gauged events for this calibration. Thus, it is common to take calibration results from gauged basins and regionalize that data for use in ungauged areas. The regionalization process relates the best estimate of the parameters from the gauged locations to readily measurable basin characteristics. That relationship (usually a regression equation) is then used in the ungauged area where the same basin characteristics can be measured and the relation used to estimate the parameters. The ungauged area analysis and regionalization process are described in Chapter 16. In performing regional analysis, it is imperative to have the parameters make good physical sense and not to use the regional equations outside the range of the data from which they were derived.

10-5. Calibration of Multisubbasin Model

The river basin model must be calibrated as a whole because the individual runoff and routing processes were calibrated for the gauged subbasins only. Also, the nonlinearities of the runoff and routing processes will cause differences from the individual component calibrations. The river basin model is calibrated using the observed precipitation data and streamflow measurements at all locations in the basin. The primary points of comparison are at gauges on the main stem of the river. Several subbasins, routing reaches, and confluences will undoubtedly have been used to compute a hydrograph at the gauge location. Several considerations and methods are necessary to calibrate the basin model. The timing, magnitude, and volume of the hydrograph must be calibrated. Sometimes one or the other is more important depending on the purpose of the study; e.g., peak flow is important for channel design, and volume is important for reservoir analysis.

a. Analysis of components. There are several components of the multisubbasin model. A detailed analysis of these components follows.

(1) General. The total flow at a gauge location is the result of several upstream processes. Sometimes the individual upstream components of the basin are routed to the gauge location to compare their relative contribution to the total hydrograph. Caution must be exercised to be sure that nonlinearities in the upstream routing processes do not adversely affect the component parts when routed individually. The component parts should be evaluated for timing, magnitude, and volume with respect to the observed hydrograph. Any inconsistent results should be traced back to their origin. The source of the problem may be in a precipitation gauge, runoff conversion processes, or the routing. At this point, it is hydrologic detective work to determine and resolve the sources of inconsistencies. Do not be too quick to blame poor results on data; check the river basin model formulation first, and be sure that the tributary drainage area is correct.

(2) Analysis of volume errors. Volume errors are the result of incorrect precipitation, detention and retention storage, and infiltration calculations. Check basin average precipitation assumptions with other gauges in the area. Check the infiltration method assumptions for the ungauged portions of the tributary basin.

(3) Analysis of timing errors. Timing errors can be the result of almost every part of the precipitation-runoff process. The precipitation and infiltration rates and patterns can cause differences in timing. More commonly, the unit hydrograph or kinematic wave land surface runoff and channel routing parameters are reviewed first. The channel routing parameter sensitivity can be easily analyzed by looking at the routed components separately. Always compare physically based estimates of travel times with the model results.

(4) Analysis of magnitude errors. Errors in peak flow can be caused by inaccurate precipitation intensities, incorrect subbasin runoff parameters, incorrect timing of tributaries, or the wrong amount of attenuation in the channel routing reaches. Precipitation distributions should be reviewed to ensure that periods of high intensity have not been averaged out by weighing the measurements of more than one recording gauge. Unit hydrograph and kinematic wave parameters should be checked with

respect to physical characteristics of the basin. Routing reaches should be reviewed for unreasonable amounts of attenuation.

b. Consistency checks. In performing the analyses of components, it is easy to independently change the individual parameters to obtain the desired result. But, such change should not be made without maintaining consistency with respect to all like land uses, soils, channels, etc. throughout the river basin. For example, if the infiltration rate is changed in one subbasin to improve the fit with the observed flows, then a corresponding change must be made in all subbasins with the same or similar land use and soil types. Consistency in runoff and routing parameters must be maintained throughout the entire river basin. Oftentimes a compromise is reached where the change helps in one location but increases the error in another location.

10-6. Verification of the Multisubbasin Model

Verification is the name of a procedure for independent checking of the parameters selected for the basin components, that is, checking the performance of the model with data not used in calibration. Independent checks of the parameters can also be made with simple measures of the physical process.

a. Other storm runoff data not used in calibration. Reserving some data for verification analysis only is

always hard to do because there never seem to be enough data for adequate calibration. Good verification results give high credibility to the model and, thus, should be performed if at all possible. Floods selected for verification should be of the size and type for which the project is being designed. If the verification results are not good, then further calibration of the model must be made using the verification flood event in addition to the previous calibration data. Any changes in the parameters must be justified with respect to all storms and the physics of the process.

b. Physics of the runoff process. The physics of the runoff and routing processes are often used to help with the calibration of the basin components. They are equally helpful in checking the river basin model results. Approximate travel times in subbasin and routing reaches can be calculated by Manning's equation. Saturated soil infiltration rates can be checked with modeled losses. Runoff per unit area (e.g., cfs per square mile) can be calculated for various points in the basin and checked for consistency with respect to precipitation. Volume checks can be made to verify overall continuity of moisture input, outflows, and water still in the system. Each one of these measures helps build confidence in the model's representation of the basin and helps gain insight into the hydrologic and hydraulic processes of the basin.

PART III

METHODS FOR FLOOD-RUNOFF
ANALYSIS

Chapter 11 Simplified Techniques

11-1. Introduction

a. Simplified techniques include numerous approaches for determining the approximate magnitude of the peak flow expected for events of varying frequency. These approaches are useful for an approximate answer with a minimum of effort. They are often used in ungauged drainage areas.

b. This chapter describes the role of simplified techniques for flood-runoff analysis. Various methods for estimating the peak flow associated with varying frequencies will be discussed including the rational method, regression techniques, SCS methods, and maximum expected envelop curves.

11-2. Rational Method

a. The so-called rational method is a popular, easy-to-use technique for estimating peak flow in any small drainage basin having mixed land use. It generally should not be used in basins larger than 1 square mile. The peak flow can be calculated by the following equation:

$$Q = CIA \quad (11-1)$$

where:

Q = peak flow, in cubic feet per second

C = runoff coefficient

I = rainfall intensity, in inches per hour

A = drainage area, in acres

b. The coefficient is the proportion of rainfall that contributes to runoff. Table 11-1 is an example of the relationship between this coefficient and land use. In basins having a significant nonhomogeneity of land use, an average coefficient can easily be determined by multiplying the percentage of each land use in the basin by its appropriate coefficient from Table 11-1.

c. The rainfall intensity is specifically defined for an event or the frequency of interest and for a duration equal to or greater than the time of concentration of the watershed. Time of concentration (T_c) is defined as the time

for runoff to travel from the most distant point of the watershed to the watershed outlet. T_c influences the shape and peak of the runoff hydrograph and is a parameter used in many simplified techniques. Numerous methods exist in the literature for estimating T_c . The SCS has developed a method that takes a physically based approach to calculating T_c , which can be found in Chapter 2 of SCS (1986).

d. Use of the rational method for large drainage areas should be discouraged because of the greater complexity of land use and drainage pattern and the unlikelihood of having uniform rainfall intensity for a duration equal to the time of concentration. The method assumes that the peak flow occurs from uniform rainfall intensity over the entire area once every portion of the basin is contributing to runoff at the outlet.

11-3. Regional Frequency Analysis

a. Regional frequency analysis usually involves regression analysis of gauged watersheds within the general region. Through this very powerful technique, sufficiently reliable equations can often be derived for peak flow of varying frequency given quantifiable physical basin characteristics and rainfall intensity for a specific duration. Once these equations are developed, they can then be applied to ungauged basins within the same region.

b. A regional analysis usually consists of the following steps:

(1) Select components of interest, such as mean and peak discharge.

(2) Select definable basin characteristics of gauged watershed: drainage area, slope, etc.

(3) Derive prediction equations with single- or multiple-linear regression analysis.

(4) Map and explain the residuals (differences between computed and observed values) that constitute "unexplained variances" in the statistical analysis on a regional basis.

c. This procedure for development of the regression equation from gauged basin data is illustrated in Figure 11-1. The equation can then be used in ungauged areas within the same region and for data of similar magnitude to that used in the development process. Much

Table 11-1
Typical C Coefficients (for 5- to 10-year Frequency Design)

DESCRIPTION OF AREA	RUNOFF COEFFICIENT
Business	
Downtown areas	0.70 - 0.95
Neighborhood area	0.50 - 0.70
Residential	
Single-family areas	0.30 - 0.50
Multiunits, detached	0.40 - 0.60
Multiunits, attached	0.60 - 0.75
Residential (suburban)	0.25 - 0.40
Apartment dwelling areas	0.50 - 0.70
Industrial	
Light areas	0.50 - 0.80
Heavy areas	0.60 - 0.90
Parks, cemeteries	0.10 - 0.25
Playgrounds	0.20 - 0.35
Railroad yard areas	0.20 - 0.40
Unimproved areas	0.10 - 0.30
Streets	
Asphaltic	0.70 - 0.95
Concrete	0.80 - 0.95
Brick	0.70 - 0.85
Drives and walks	0.75 - 0.85
Roofs	0.75 - 0.95
Lawns, Sandy soil	
Flat, 2%	0.05 - 0.10
Average, 2-7%	0.10 - 0.15
Steep, 7%	0.15 - 0.20
Lawns, Heavy soil	
Flat, 2%	0.13 - 0.17
Average, 2-7%	0.18 - 0.22
Steep, 7%	0.25 - 0.35

(from Viessman et al. 1977)

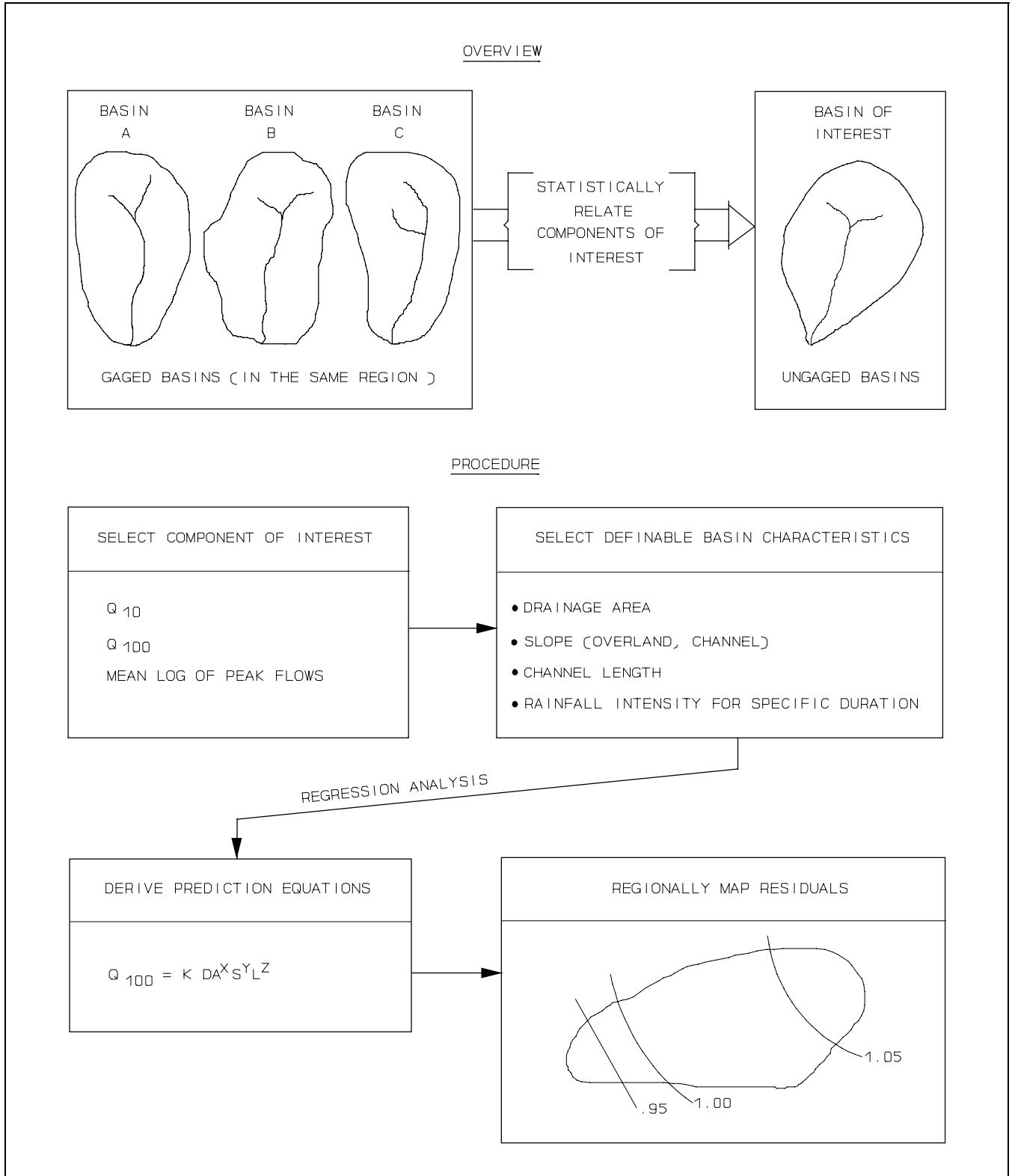

Figure 11-1. Regional analysis

EM 1110-2-1417
31 Aug 94

more detail on regression and regional frequency analysis is available in EM 1110-2-1415, Hydrologic Frequency Analysis.

d. Regional equations have already been developed by the U.S. Geological Survey (USGS) and published for the various areas of the United States. An example of this type of equation is the following:

$$Q_{100} = 19.7 A^{0.88} P^{0.84} H^{-0.33} \quad (11-2)$$

where

Q_{100} = the 1 percent chance flood peak, in cubic feet per second

A = drainage area, in square miles

P = mean annual precipitation, in inches

H = average main channel elevation at 10 and 85 percent points along the main channel length, in 1,000 ft

e. Table 11-2 illustrates various examples of regional equations for the entire state of California. These equations make no assumptions regarding statistical distribution or skew. Both characteristics are inherent in the data used to develop the regression equations. These predeveloped USGS regional equations may or may not be as good as ones developed specifically for the region of interest; but they are already available, and development of regional equations is an expensive approach.

f. In contrast to the USGS regional equations shown above, the USACE usually develops regional frequency equations as documented in EM 1110-2-1415. The USACE type equations are of the following form:

$$Q = \bar{X} + kS \quad (11-3)$$

$$\bar{X} = aA^b L^c (1+I)^d \quad (11-4)$$

$$S = eA^f G^g L^h \quad (11-5)$$

where

Q = flood peak for varying frequency, in cubic feet per second

\bar{X} = mean of the logarithms of annual series peak flood events, in cubic feet per second

k = log Pearson type II deviates

S = standard deviation of the logarithms annual series peak flood events, in cubic feet per second

$A, L, I \& G$ = various (some are logarithmic) quantifiable physical basin characteristics

$a \& e$ = represent regression constants

$b, c, d, f, g \& h$ = represent regression coefficients

g. The USACE methods assume a log Pearson type III distribution for “k” values and a weighted skew coefficient for peak flood events. The equation provides a peak flow for various frequency levels associated with the value of “k.” Values of “k” are found in various USACE literature such as the EM 1110-2-1415.

h. Other governmental agencies (i.e., city and county) have developed regional frequency equations, but they may be difficult to locate.

i. Regardless of the source of the equations, the user must identify the standard error of estimate (SE) associated with the equation. The SE of estimate defines the possible range of error in the value of flow predicted by the regression equation. Assuming the error is log normally distributed, there is a 68 percent chance that the “true value” of flow is within ± 1 SE and a 95 percent chance that it is within ± 2 SE.

j. For the example of the USGS equation for Q_{100} (the Central Coast region of California), the standard error is 0.41 log units. The true value of Q_{100} is within \pm anti-log of $(0.41 + \log Q_{100})$. It can then be stated with 68 percent confidence that for the example above where the equation predicted the Q_{100} to be 1,000 cfs, the true value is between 2,570 and 389 cfs. Since the calculated flows (Q_{100}) for this data set vary from 159 cfs to 30,682 cfs, the example of Q_{100} at 1,000 cfs is not an unlikely case. This large range in confidence limits is not unusual for a regression approach. Often this approach is the best available technique to estimate the flow frequency at ungauged locations.

k. Again, it bears repeating that when using regression equations from any source, make sure the equations were developed within the region of interest, the basin characteristics for the watershed of interest are within the range of those used to derive the equations, and the

Table 11-2
Regional Flood-Frequency Equations for California

NORTH COAST REGION¹

$$\begin{aligned} Q_2 &= 3.52 A^{.90} P^{.89} H^{-.47} & (1) \\ Q_5 &= 5.04 A^{.89} P^{.91} H^{-.35} & (2) \\ Q_{10} &= 6.21 A^{.88} P^{.93} H^{-.27} & (3) \\ Q_{25} &= 7.64 A^{.87} P^{.94} H^{-.17} & (4) \\ Q_{50} &= 8.57 A^{.87} P^{.96} H^{-.08} & (5) \\ Q_{100} &= 9.23 A^{.87} P^{.97} & (6) \end{aligned}$$

SIERRA REGION

$$\begin{aligned} Q_2 &= 0.24 A^{.88} P^{1.58} H^{-.80} & (13) \\ Q_5 &= 1.20 A^{.82} P^{1.37} H^{-.64} & (14) \\ Q_{10} &= 2.63 A^{.80} P^{1.25} H^{-.58} & (15) \\ Q_{25} &= 6.55 A^{.79} P^{1.12} H^{-.52} & (16) \\ Q_{50} &= 10.4 A^{.78} P^{1.06} H^{-.48} & (17) \\ Q_{100} &= 15.7 A^{.77} P^{1.02} H^{-.43} & (18) \end{aligned}$$

SOUTH COAST REGION
REGION²

$$\begin{aligned} Q_2 &= 0.41 A^{.72} P^{1.62} & (25) \\ Q_5 &= 0.40 A^{.77} P^{1.69} & (26) \\ Q_{10} &= 0.63 A^{.79} P^{1.75} & (27) \\ Q_{25} &= 1.10 A^{.81} P^{1.81} & (28) \\ Q_{50} &= 1.50 A^{.82} P^{1.85} & (29) \\ Q_{100} &= 1.95 A^{.83} P^{1.87} & (30) \end{aligned}$$

NORTH EAST REGION²

$$\begin{aligned} Q_2 &= 22 A^{.40} & (7) \\ Q_5 &= 46 A^{.45} & (8) \\ Q_{10} &= 61 A^{.49} & (9) \\ Q_{25} &= 84 A^{.54} & (10) \\ Q_{50} &= 103 A^{.57} & (11) \\ Q_{100} &= 125 A^{.59} & (12) \end{aligned}$$

CENTRAL COAST REGION

$$\begin{aligned} Q_2 &= 0.0061 A^{.92} P^{2.54} H^{-1.10} & (19) \\ Q_5 &= 0.118 A^{.91} P^{1.95} H^{-.79} & (20) \\ Q_{10} &= 0.583 A^{.90} P^{1.61} H^{-.64} & (21) \\ Q_{25} &= 2.91 A^{.89} P^{1.26} H^{-.50} & (22) \\ Q_{50} &= 8.20 A^{.89} P^{1.03} H^{-.41} & (23) \\ Q_{100} &= 19.7 A^{.88} P^{0.84} H^{-.33} & (24) \end{aligned}$$

SOUTH - COLORADO DESERT

$$\begin{aligned} Q_2 &= 7.3 A^{.30} & (31) \\ Q_5 &= 53 A^{.44} & (32) \\ Q_{10} &= 150 A^{.53} & (33) \\ Q_{25} &= 410 A^{.63} & (34) \\ Q_{50} &= 700 A^{.68} & (35) \\ Q_{100} &= 1080 A^{.71} & (36) \end{aligned}$$

where:

Q = Peak discharge, in cubic feet per second

A = Drainage area, in square miles

P = Mean annual precipitation, in inches

H = Altitude index, in thousands of feet

Notes:

¹ In the north coast region, use a minimum value of 1.0 for altitude index (H).

² These equations are defined only for basins of 25 square miles or less.

confidence of the predicted peak flow value is evaluated by assessing the magnitude of ± 1 SE.

11-4. Envelope Curves

a. The maximum “credible” peak discharge at any site (usually ungauged) can be estimated by using envelope curves. Although the result has no frequency associated with it, the maximum peak discharge may be useful for comparison with a family of peak discharges at various frequencies obtained by techniques discussed in previous paragraphs 11-2 and 11-3 of this manual.

b. Figure 11-2 is first used to determine the region number for the geographical area of interest. Select the appropriate envelope curve for the region of interest. An example regional envelope curve is shown in Figure 11-3. With the known drainage area, determine the maximum peak discharge.

c. More extensive discussion regarding envelope curves can be found in USGS Water Supply Papers 1887 (Crippen and Bue 1977) and 1850-B (Matthai 1969); Water Resources Investigations 77-21 (Waananen and

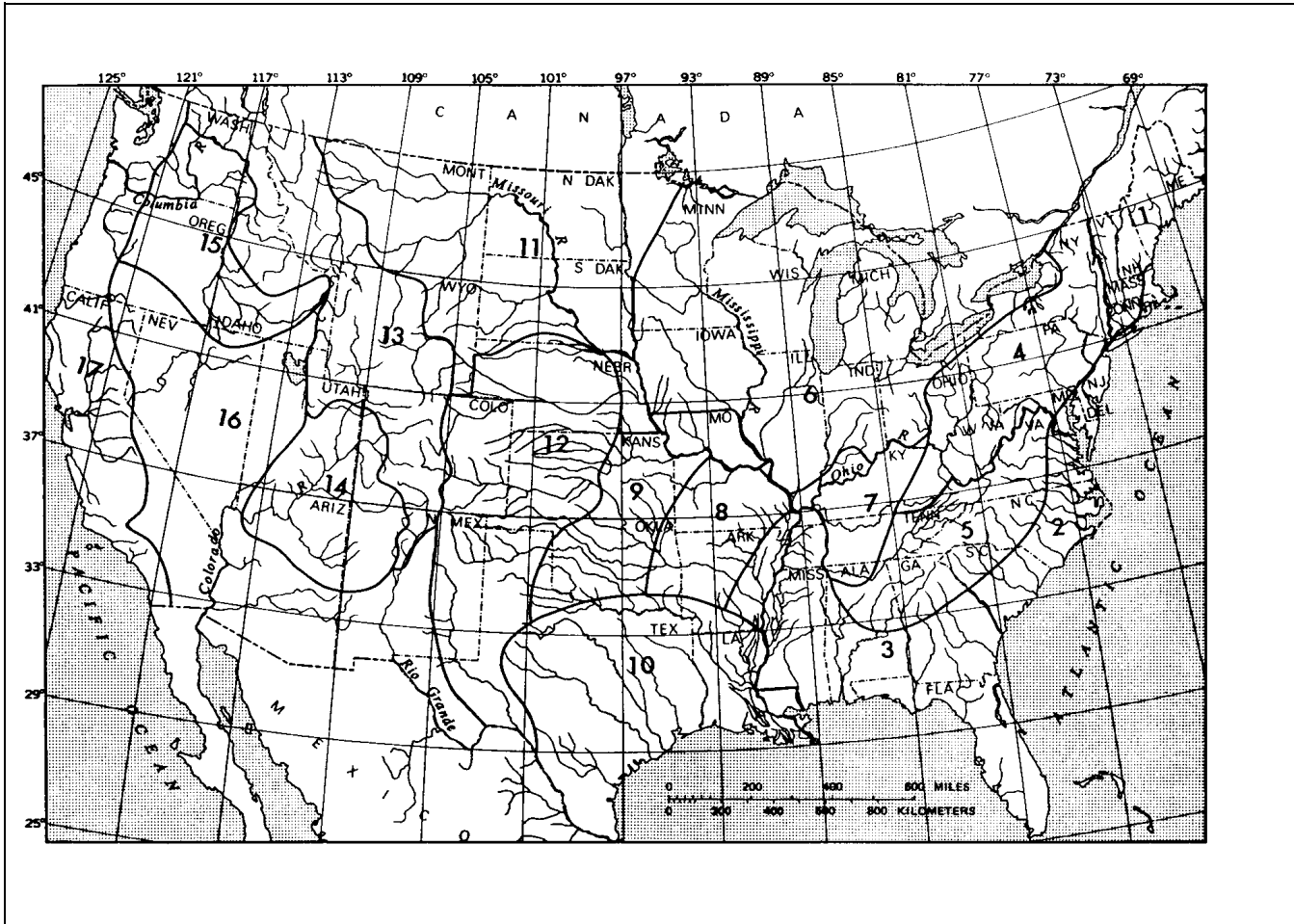

Figure 11-2. Map of the conterminous United States showing flood-region boundaries

Crippen 1977); and the American Society of Civil Engineers, *Hydraulic Journal* (Crippen 1982).

11-5. Rainfall Data Sources

This section lists the most current 24-hour rainfall data published by the National Weather Service (NWS) for various parts of the country. For the area generally west of the 105th meridian, TP-40 has been superseded by the (NOAA) Atlas 2, "Precipitation-Frequency Atlas of the Western United States," published by the NOAA.

a. East of 105th Meridian (Hershfield 1961). "Rainfall Frequency Atlas of the United States for Durations from 30 Minutes to 24 Hours and Return Periods from 1 to 100 Years," U.S. Department of Commerce, Weather Bureau, Technical Paper No. 40, Washington, DC. For durations of 1 hour and less, TP40 has been superseded by Hydrometeorological Report No. 35,

U.S. Department of Commerce, National Weather Service, Silver Springs, MD.

b. West of 105th Meridian (Miller, Frederick, and Tracey 1973). "Precipitation-Frequency Atlas of the Western United States, Volume I, Montana; Volume II, Wyoming; Volume III, Colorado; Volume IV, New Mexico; Volume V, Idaho; Volume VI, Utah; Volume VII, Nevada; Volume VIII, Arizona; Volume IX, Washington; Volume X, Oregon; Volume XI, California," U.S. Department of Commerce, National Weather Service, NOAA Atlas 2, Silver Springs, MD.

c. Alaska (Miller 1963). "Probable Maximum Precipitation and Rainfall-Frequency Data for Alaska for Areas to 400 Square Miles, Durations to 24 Hours and Return Periods From 1 to 100 Years," U.S. Department of Commerce, Weather Bureau, Technical Paper No. 47, Washington, DC.

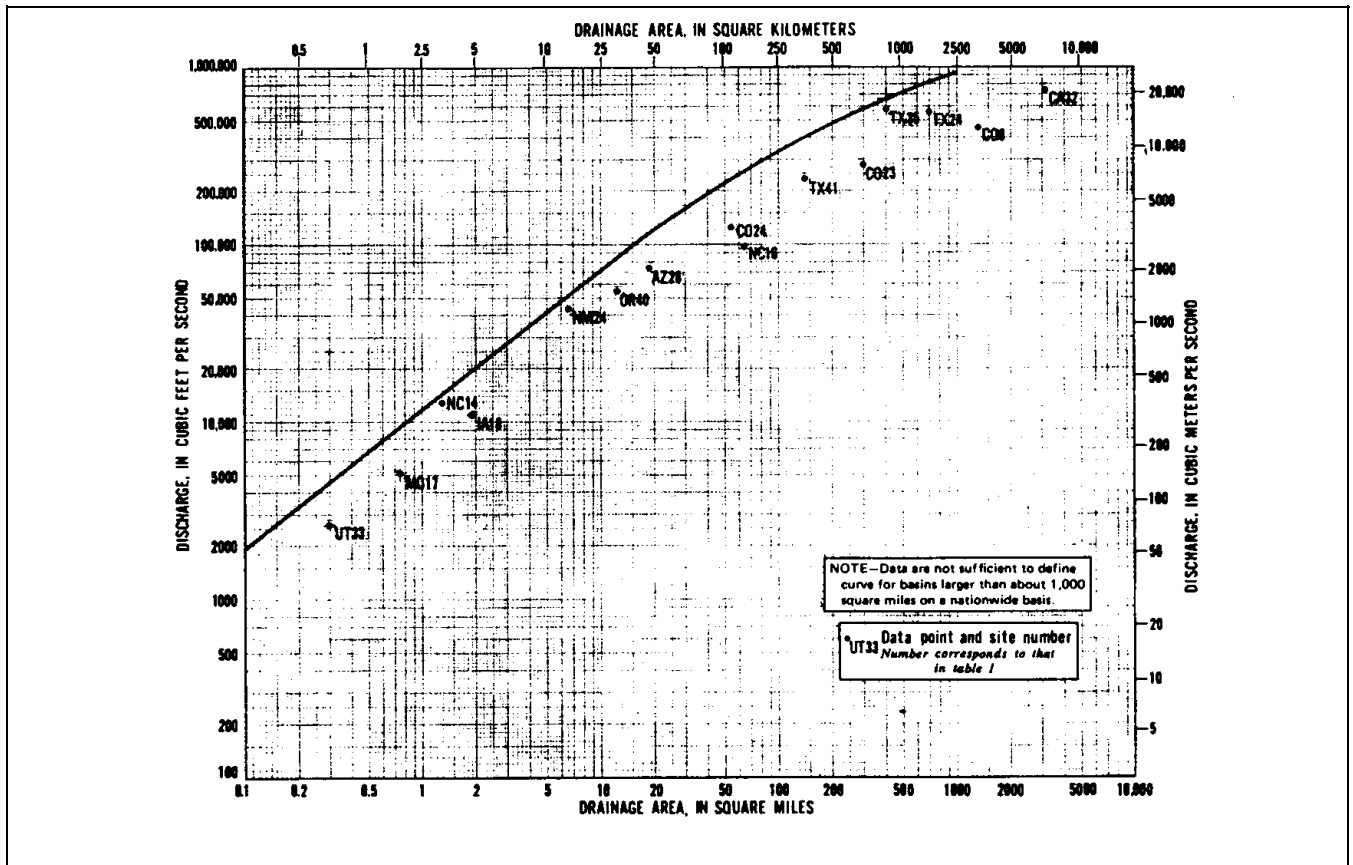

Figure 11-3. Peak discharge versus drainage area, and envelope curve for Region 1

d. *Hawaii* (U.S. Department of Commerce 1962). "Rainfall-Frequency Atlas of the Hawaiian Islands for Areas to 200 Square Miles, Duration to 24 Hours and Return Periods From 1 to 100 Years," U.S. Department of Commerce, Weather Bureau, Technical Paper No. 43, Washington, DC.

Maximum Precipitation and Rainfall-Frequency Data for Puerto Rico and Virgin Islands for Areas to 400 Square Miles, Durations to 24 Hours, and Return Periods From 1 to 100 years," U.S. Department of Commerce, Weather Bureau, Technical Paper No. 42, Washington, DC.

e. *Puerto Rico and Virgin Islands* (U.S. Department of Commerce 1961). "Generalized Estimates of Probable

Chapter 12 Frequency Analysis of Streamflow Data

12-1. General

Frequency analysis of recorded streamflow data is an important flood-runoff analysis tool. This chapter describes the role of frequency analysis and summarizes the technical procedures. EM 1110-2-1415 describes the procedures in greater detail.

a. Role of frequency analysis.

(1) The traditional solution to water-resource planning, designing, or operating problems is a deterministic solution. With a deterministic solution, a critical hydro-meteorological event is selected. This event is designated the design event. Plans, designs, or operating policies are selected to accommodate that design event. For example, the maximum discharge observed in the last 40 years may be designated the design event. A channel modification may be designed to pass, without damage, this design event. If this design event is not exceeded in the next 1,000 years, the design may not be justified. On the other hand, if the discharge exceeds the design event 20 times in the next 30 years, the channel modification may be underdesigned.

(2) A probabilistic solution employs principles of statistics to quantify the risk that various hydrometeorological events will be exceeded. Risk is quantified in terms of probability. The greater the risk, the greater the probability. If an event is certain to occur, its probability is 1.00. If an event is impossible, its probability is 0.00. For flood-runoff analyses, the probability of exceedance is usually the primary interest. This is a measure of the risk that discharge will exceed a specified value. Decisions are taken so that the risk of exceedance is acceptable. For example, the channel modification described above could be designed for a discharge magnitude with an annual exceedance probability of 0.01. In that case, the risk is known and is accounted for explicitly in the decision making.

b. Definition of frequency analysis.

(1) The objective of streamflow frequency analysis is to infer the probability of exceedance of all possible discharge values (the parent population) from observed discharge values (a sample of the parent population). This process is accomplished by selecting a statistical model that represents the relationship of discharge magnitude

and exceedance probability for the parent population. The parameters of the models are estimated from the sample. With the calibrated model, the hydrologic engineer can predict the probability of exceedance for a specified magnitude or the magnitude with specified exceedance probability. This magnitude is referred to as a quantile.

(2) For convenience, a statistical model may be displayed as a frequency curve. Figure 12-1 is an example of a frequency curve. The magnitude of the event is the ordinate. Probability of exceedance is the abscissa. For hydrologic engineering studies, the abscissa commonly shows "percent chance exceedance." This is exceedance probability multiplied by 100.

(3) In some sense, frequency analysis is a model-fitting problem similar to the precipitation-runoff analysis problem described in Chapter 8. In both cases, a model must be selected to describe the desired relationship, and the model must be calibrated with observed data.

c. Summary of streamflow frequency analysis techniques. Techniques for selecting and calibrating streamflow frequency models may be categorized as graphical or numerical. With graphical techniques, historical observations are plotted on specialized graph paper and the curves are fitted by visual inspection. Numerical techniques infer the characteristics of the model from statistics of the historical observations. The procedures for both graphical and numerical analysis are presented in detail in EM 1110-2-1415 and are summarized herein for ready reference.

12-2. Frequency Analysis Concepts

a. Data requirements. Statistical models of streamflow frequency are established by analyzing a sample of the variable of interest. For example, to establish a statistical model of annual peak discharge, the sample will be a series of annual peaks observed throughout time. The procedures of statistical analysis require the following of any time series used in frequency analysis:

(1) Data must be homogeneous. That is, the data must represent measurements of the same aspect of each event. For example, daily discharge observations should not be combined with peak discharge observations. Furthermore, all sample points must be drawn from the same parent population. For example, rain-flood data and snowmelt-flood data should not be combined if they can be identified and analyzed separately. Likewise, discharge data observed after development upstream should not be combined with predevelopment data.

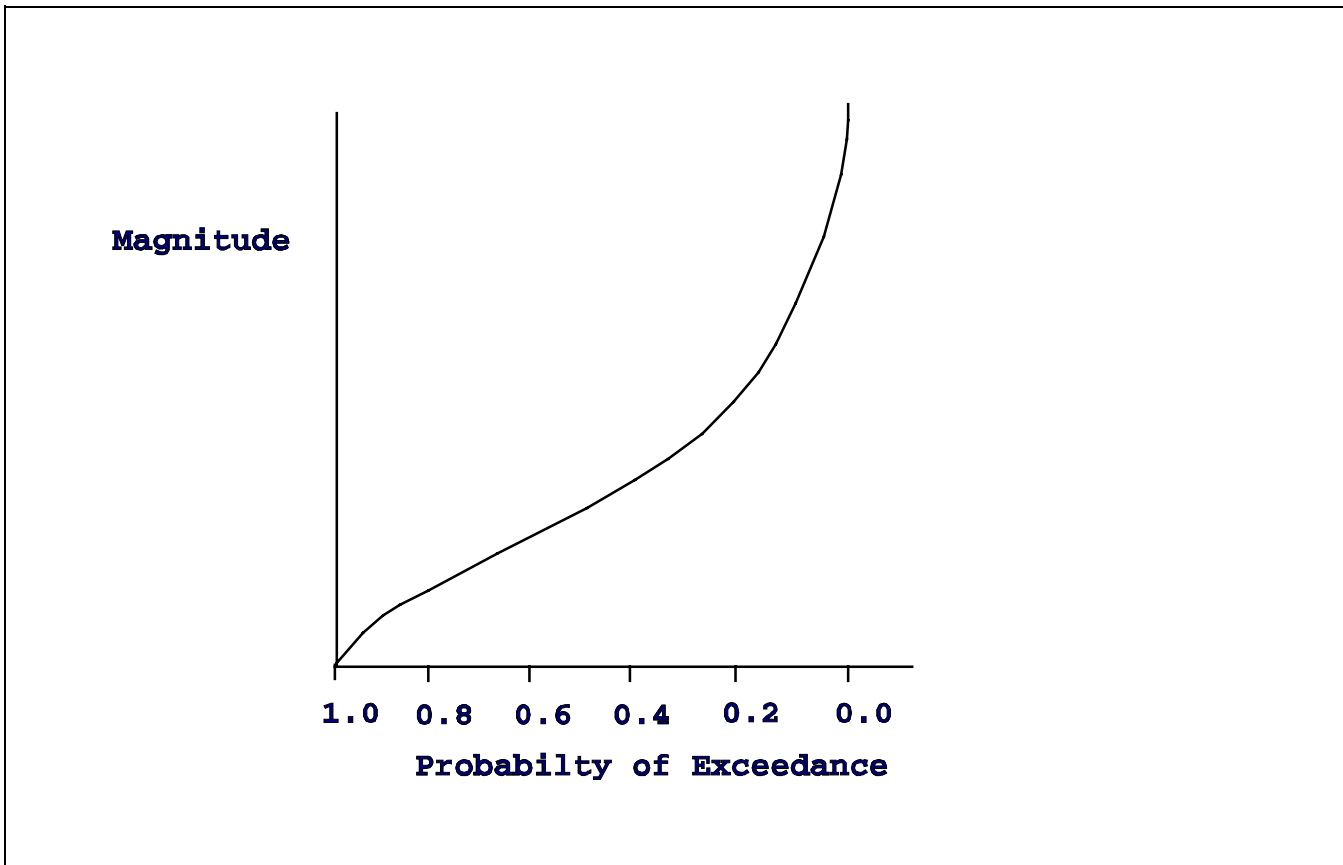

Figure 12-1. Frequency curve example

(2) Data must be spatially consistent. All data should be observed at the same location. Data observed at different locations may be used to develop probability estimates. However, these data must be adjusted to represent conditions at a common location.

(3) Time series must be continuous. Statistical analysis procedures require an uninterrupted series. If observations are missing, the missing values must be estimated, or techniques for analysis of broken records must be used.

b. Probability estimates from historical data.

(1) Streamflow probability is estimated from analysis of past occurrence. The simplest model of the relationship of streamflow magnitude and probability is a relative frequency model. This model estimates the probability of exceeding a specified magnitude as the fraction of time the magnitude was exceeded historically. For example, if the mean daily discharge at a given location exceeds

80 cfs in 6,015 of 8,766 days, the relative frequency is 0.68. The estimated probability of exceedance of 80 cfs is 0.68.

(2) Figure 12-2 is a graphical representation of the relative frequency models of mean daily flow in Fishkill Creek at Beacon, NY. Such a plot is commonly referred to as a duration curve. The abscissa of this plot shows "percent of time exceeded." This equals relative frequency multiplied by 100, so it is consistent with the term "percent chance exceedance."

(3) The reliability of a relative frequency model improves as the sample size increases; with an infinite sample size, relative frequency exactly equals the probability. Unfortunately, sample sizes available for streamflow frequency analysis are small by scientific standards. Thus, relative frequency generally is not a reliable estimator of probability for hydrologic engineering purposes.

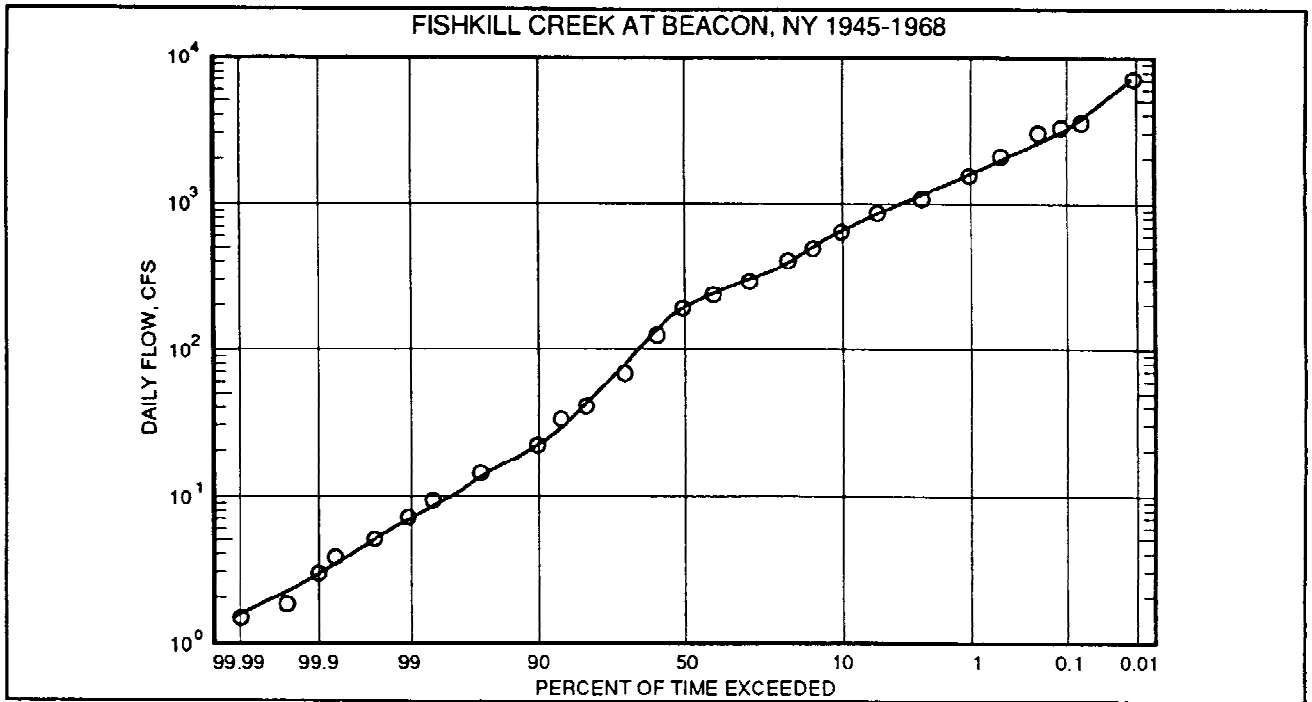

Figure 12-2. Graphical representation of relative frequency model

(4) The alternative to the empirical relative frequency model is a theoretical frequency model. With a theoretical model, the relationship of magnitude and probability for the parent population is hypothesized. The relationship is represented by a frequency distribution. A cumulative frequency distribution is an equation that defines probability of exceedance as a function of specified magnitude and one or more parameters. An inverse distribution defines magnitude as a function of specified probability and one or more parameters.

c. Distribution selection and parameter estimation. In certain scientific applications, one distribution or another may be indicated by the phenomena of interest. This is not so in hydrologic engineering applications. Instead, a frequency distribution is selected because it models well the data that are observed. The parameters for the model are selected to optimize the fit. A graphical or numerical technique can be used to identify the appropriate distribution and to estimate the parameters.

12-3. Graphical Techniques

Some of the early and simplest methods of frequency analysis were graphical techniques. These techniques permit inference of the parent population characteristics with a plot of observed magnitude versus estimated

exceedance probability of that data. If a best-fit line is drawn on the plot, the probability of exceeding various magnitudes can be estimated. Also, any desired quantiles can be estimated. Graphical representations also provide a useful check of the adequacy of a hypothesized distribution.

a. Plotting-position estimates of probability.

(1) Graphical techniques rely on plotting positions to estimate exceedance probability of observed events. The median plotting position estimates the exceedance probability as:

$$P_m = \frac{(m - 0.3)}{(N + 0.4)} \tag{12-1}$$

where:

P_m = exceedance probability estimate for the m th largest event

m = the order number of the event

N = the number of events

For example, to estimate annual exceedance probability of annual maximum discharge, N = the number of years of data. To express the results as percent-chance exceedance, the results of Equation 12-1 are multiplied by 100.

(2) Table 12-1 shows plotting positions for annual peak discharge on Fishkill Creek. Column 4 of the table shows the discharge values in the sequence of occurrence. Column 7 shows these same discharge values arranged in order of magnitude. Column 5 is the order number of each event. Column 8 shows the plotting position. These plotting positions are values computed with Equation 12-1 and multiplied by 100. The values in columns 7 and 8 thus are an estimate of the peak-discharge frequency distribution.

b. Display and use of estimated frequency curve.

(1) The estimated frequency distribution is displayed on a grid with the magnitude of the event as the ordinate and probability of exceedance (or percent-chance exceedance) as the abscissa. The plot thus provides a useful tool for estimating quantiles or exceedance probabilities. Specialized plotting grids are available for the display. These grids are constructed with the abscissa scaled so a selected frequency distribution plots as a straight line. For example, a specialized grid was developed by Hazen for the commonly used normal frequency distribution.

(2) The specialized normal-probability grid is a useful tool for judging the appropriateness of the normal

Table 12-1
Annual Peaks, Sequential and Ordered with Plotting Positions (Fishkill Creek at Beacon, NY)

Events Analyzed				Ordered Events			
Mon (1)	Day (2)	Year (3)	Flow, cfs (4)	Rank (5)	Water Year (6)	Flow, cfs (7)	Median Plot Pos (8)
3	5	1945	2,290.	1	1955	8,800.	2.87
12	27	1945	1,470.	2	1956	8,280.	6.97
3	15	1947	2,220.	3	1961	4,340.	11.07
3	18	1948	2,970.	4	1968	3,630.	15.16
1	1	1949	3,020.	5	1953	3,220.	19.26
3	9	1950	1,210.	6	1952	3,170.	23.36
4	1	1951	2,490.	7	1962	3,060.	27.46
3	12	1952	3,170.	8	1949	3,020.	31.56
1	25	1953	3,220.	9	1948	2,970.	35.66
9	13	1954	1,760.	10	1958	2,500.	39.75
8	20	1955	8,800.	11	1951	2,490.	43.85
10	16	1955	8,280.	12	1945	2,290.	47.95
4	10	1957	1,310.	13	1947	2,220.	52.05
12	21	1957	2,500.	14	1960	2,140.	56.15
2	11	1959	1,960.	15	1059	1,960.	60.25
4	6	1960	2,140.	16	1963	1,780.	64.34
2	26	1961	4,340.	17	1954	1,760.	68.44
3	13	1962	3,060.	18	1967	1,580.	72.54
3	28	1963	1,780.	19	1946	1,470.	76.64
1	26	1964	1,380.	20	1964	1,380.	80.74
2	9	1965	980.	21	1957	1,310.	84.84
2	15	1966	1,040.	22	1950	1,210.	88.93
3	30	1967	1,580.	23	1966	1,040.	93.03
3	19	1968	3,630.	24	1965	980.	97.13

distribution as a model of the parent population. If data drawn from a normally distributed parent population are assigned plotting positions using Equation 12-1 and are plotted on Hazen's grid, the points will fall approximately on a straight line. If the points do not, then either the sample was drawn from a population with a different distribution or sampling variation yielded a nonrepresentative sample.

(3) A specialized plotting grid has been developed also for another commonly used frequency distribution, the log-normal distribution. Figure 12-3 is an example of such a grid. The values from columns 7 and 8 of Table 12-1 are plotted on this grid, and a frequency curve is fitted. If the data are truly drawn from the distribution of a log-normal parent population, the points will fall on a

straight line. The Fishkill Creek data, shown by Figure 12-3, do not fall on a straight line, so the assumption that the parent population is a log-normal distribution is suspect.

12-4. Numerical Techniques

Numerical techniques define the relationship between streamflow magnitude and probability with analytical tools, instead of the graphical tools.

a. Steps of numerical techniques. With numerical techniques, the following general steps are used to derive a frequency curve to represent the population (McCuen and Snyder 1986):

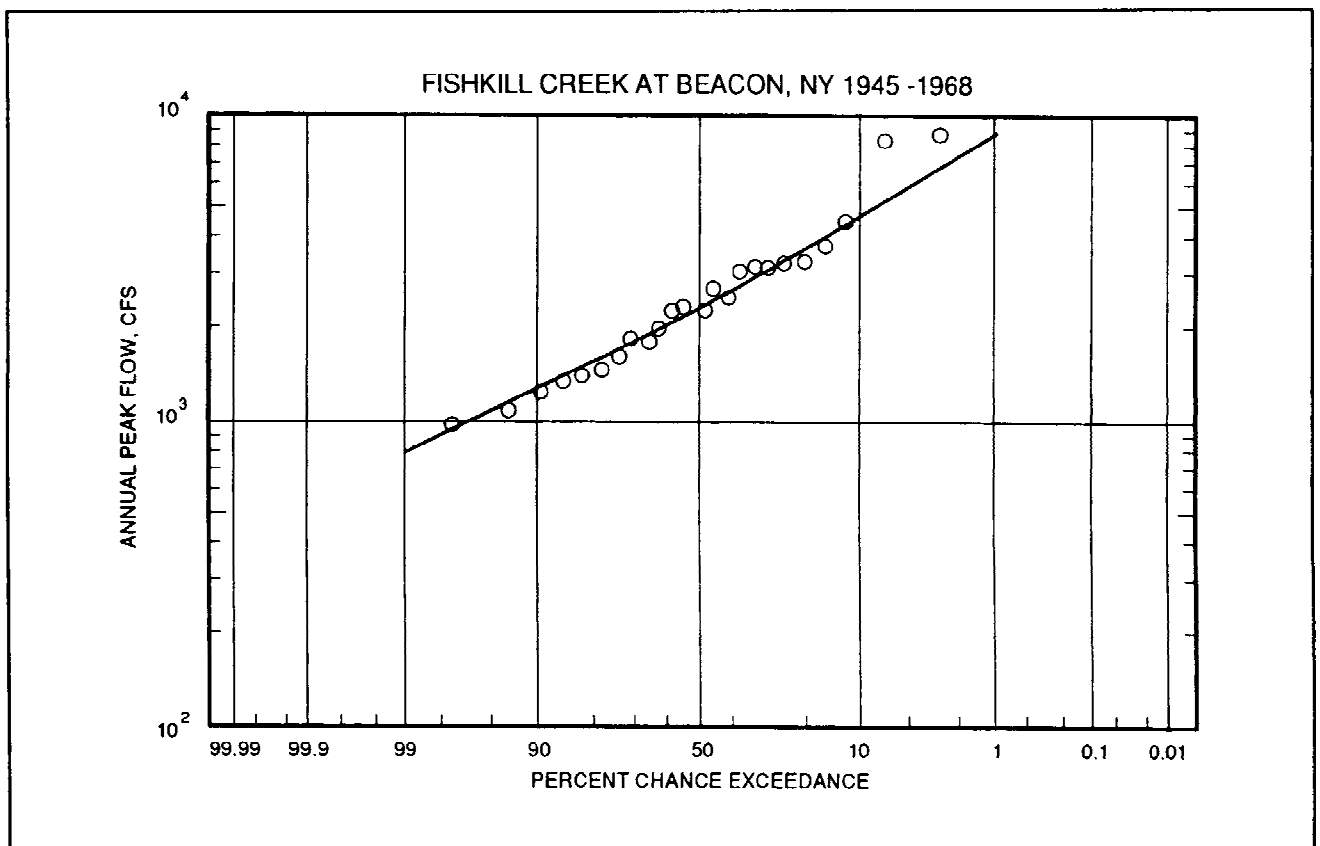

Figure 12-3. Log-normal probability grid

(1) Select a candidate frequency model of the parent population. Three distributions are commonly used for frequency analysis of hydrometeorological data: the normal distribution, the log-normal distribution, and the log Pearson type III distribution.

(2) Obtain a sample.

(3) Use the sample to estimate the parameters of the model identified in step 1.

(4) Use the model and the parameters to estimate quantiles to construct the frequency curve that represents the parent population.

b. Numerical parameter estimation.

(1) Parameters of a statistical model are commonly estimated from a sample with method-of-moments estimators. The method-of-moments parameter estimators are developed from the following assumptions:

(a) The streamflow-probability relationship of the parent population can be represented with a selected distribution. The moments (derivatives) of the distribution equation can be determined with calculus. One moment is determined for each parameter of the distribution. The resulting expressions are equations in terms of the parameters of the distribution.

(b) Moments of a sample of the parent population can be computed numerically. The first moment is the mean of the sample; the second moment is the variance; the third moment is the sample skew. Other moments can be found if the distribution selected has more than three parameters.

(c) The numerical moments of the sample are the best estimates of the moments of the parent population. This assumption permits development of a set of simultaneous equations. The distribution parameters are unknown in the equations. Solution yields estimates of the parameters.

(2) When the parameters of the distribution are estimated, the inverse distribution defines the quantiles of the frequency curve. Chow (1951) showed that with the method-of-moments estimates, many inverse distributions commonly used in hydrologic engineering could be written in the following general form:

$$Q_p = \bar{Q} + K_p S \quad (12-2)$$

where:

Q_p = the quantile with specified exceedance probability p

\bar{Q} = the sample mean

S = the sample standard deviation

K_p = a frequency factor

The sample mean and standard deviation are computed with the following equations:

$$\bar{Q} = \frac{\sum Q_i}{N} \quad (12-3)$$

$$S = \left(\frac{\sum (Q_i - \bar{Q})^2}{(N - 1)} \right)^{0.5} \quad (12-4)$$

where:

Q_i = observed event i

N = number of events in sample

(3) The frequency factor in Equation 12-2 depends on the distribution selected. It is a function of the specified exceedance probability and, in some cases, other population parameters. The frequency factor function can be tabulated or expressed in mathematical terms. For example, normal-distribution frequency factors corresponding to the exceedance probability p ($0 < p < 0.5$) can be approximated with the following equations (Abramowitz and Stegun 1965):

$$K_p = w - \left[\frac{(2.515517 + 0.802853 w + 0.010328 w^2)}{(1 + 1.432788 w + 0.189269 w^2 + 0.001308 w^3)} \right] \quad (12-5)$$

$$w = \left[\ln \left(\frac{1}{p^2} \right) \right]^{0.5} \quad (12-6)$$

where:

w = an intermediate variable, if $p > 0.5$, $(1 - p)$ is used in Equation 12-6, and the computed value of K_p is multiplied by -1.

(4) For the log-normal distribution, Equation 12-2 is written as:

$$X_p = \bar{X} + K_p S \quad (12-7)$$

where:

X_p = the logarithm of Q_p , the desired quantile
 X = mean of logarithms of sample
 S = standard deviation of logarithms of sample
 K_p = the frequency factor

This frequency factor is the same as that used for the normal distribution. X and S are computed with the following equations:

$$\bar{X} = \frac{\sum \log Q_i}{N} \quad (12-8)$$

$$S = \left(\frac{\sum (\log Q_i - \bar{X})^2}{(N - 1)} \right)^{0.5} \quad (12-9)$$

where:

Q_i = observed peak annual discharge in year i
 N = number of years in sample

For the annual peak discharge values shown in Table 12-1, these values are as follows: $X = 3.3684$, and $S = 0.2456$.

c. Recommended procedure for annual maximum discharge.

(1) The U.S. Water Resources Council (USWRC) (1967, 1976, 1977) recommended the log Pearson type III distribution for annual maximum streamflow frequency studies. This recommendation is followed by USACE. Current guidelines are presented in Bulletin 17B (USWRC 1981).

(2) The log Pearson type III distribution models the frequency of logarithms of annual maximum discharge. Using Chow's (1951) format, the inverse log Pearson type III distribution is

$$X_p = \bar{X} + KS \quad (12-10)$$

where:

X_p = the logarithm of Q_p , the desired quantile
 X = mean of logarithms of sample
 S = standard deviation of logarithms of sample
 K = the Pearson frequency factor

X and S are computed with the Equations 12-8 and 12-9.

(3) For this distribution, the frequency factor K is a function of the specified probability and of the skew of the logarithms of the sample. The skew, G , is computed with the following equation:

$$G = \frac{[N \sum (X_i - X)^3]}{[(N - 1)(N - 2)S^3]} \quad (12-11)$$

For the values of Table 12-1, the skew computed with Equation 12-11 is 0.7300.

(4) The log Pearson type III frequency factors for selected values of skew and exceedance probability are tabulated in Bulletin 17B (USWRC 1981) and in EM 1110-2-1415. Alternatively, an approximating

function can be used. If the skew equals zero, the Pearson frequency factors equal the normal distribution factors. Otherwise, the following approximation suggested by Kite (1977) can be used:

$$K = K_p + (K_p^2) k + \left(\frac{1}{3}\right) (K_p^3 - 6K_p) k^2 - (K_p^2 - 1) k^3 + K_p k^4 + \left(\frac{1}{3}\right) k^5 \quad (12-12)$$

where $k = G/6$.

d. Analysis of special cases.

(1) In hydrologic engineering applications, frequency analysis of annual maximum discharge is complicated by special cases. These include broken records, incomplete records, zero-flow years, outliers, historical data, and small samples. Bulletin 17B provides guidance for dealing with these cases.

(2) If 1 or more years of data are missing from a time series of annual maximum discharge due to reasons not related to flood magnitude, the record is broken. For analysis, the record segments are combined, and the combined record is analyzed as previously described.

(3) If data are missing because the events were too large to record, too small to record, or the gauge was destroyed by a large event, the record is incomplete. Any missing large events should be estimated and the estimates included in the time series. Missing small events are treated with the conditional probability adjustment recommended for zero-flow years.

(4) The log Pearson type III distribution is not suited to analysis of series which include zero-flow years. If the sample contains zero-flow years, the record is analyzed using the conditional probability procedure. With this procedure, the subseries of nonzero peaks is analyzed as described previously. The resulting frequency curve is a conditional frequency curve. The exceedance frequencies from this curve are scaled by the relative frequency of non-zero flow years. The log Pearson type III model parameters are estimated for the upper portion of the curve. With these parameters, a synthetic frequency curve is developed. Paragraph 3-6 of EM 1110-2-1415 describes the procedure.

(5) An outlier is an observation that departs significantly from the trend of the remaining data. Procedures for treating outliers require hydrologic and mathematical judgment. Bulletin 17B describes one procedure for identifying high and low outliers and for censoring the data set. High outliers are treated as historical data if sufficient information is available. Low outliers are treated as zero-flow years.

(6) Large floods outside the systematically recorded time series may be used to extend that record. The procedure recommended for analysis of these historical flows is as follows:

(a) Assemble known historic peaks and determine the historic record length.

(b) Censor the systematic record by deleting all peaks less than the minimum historical peak. Estimate the model parameters for the remaining record.

(c) Compute a weight with the following equation:

$$W = \frac{(H - Z)}{(N + L)} \quad (12-13)$$

where:

W = the weight

H = number of years in historic record

Z = number of historic event

N = number of years in censored systematic record

L = number of zero-flow years, low outliers, missing years excluded from systematic record

(d) Adjust the model parameters with this weight. Equations for the adjustments are presented in Appendix 6 of Bulletin 17B (USWRC 1981). Compute the quantiles with these modified parameters and Equation 12-10.

(7) Small samples adversely affect the reliability of estimates of the skew. This parameter is difficult to estimate accurately from a small sample. A more reliable estimate is obtained by considering skew characteristics of all available streamflow records in a large region. An

adopted skew is computed as a weighted sum of this regional skew and the skew computed with Equation 12-11. The weights chosen are a function of the sample skew of the logs, the sample record length, the generalized skew, and the accuracy in developing the generalized values. The generalized skew can be determined from a map included in Bulletin 17B, or it can be determined from detailed analyses if additional data are available.

(8) The impact of uncertainty due to small sample size can be quantified further with the expected probability adjustment. This adjustment is based on the argument that the x percent-chance discharge estimate made with a given sample is approximately the median of all estimates that would be made with successive samples of the same size. However, the probability distribution of the estimate is skewed, so the average of the samples exceeds the median. The consequence of this is that if a very large number of estimates of flood magnitude are made over a region, more x percent-chance floods will occur than expected on the average (Chow, Maidment, and Mays 1988). For example, more "100-year floods" will occur in the United States annually than expected. Paragraph 3-4 of EM 1110-2-1415 describes how either the probability associated with a specified magnitude or the magnitude for a specified probability can be adjusted to obtain a frequency curve with the expected number of exceedances.

e. Verification of frequency estimates.

(1) The reliability of frequency estimates depends on how well the proposed model represents the parent population. The fit can be tested indirectly with a simple graphical comparison of the fitted model and the sample or with a more rigorous statistical test. The reliability can also be illustrated with confidence limits.

(2) A graphical test provides a quick method for verifying frequency estimates derived with numerical procedures. The test is performed by plotting observed magnitude versus plotting-position estimates of exceedance probability. The postulated frequency curve with best-estimate parameters is plotted on the same grid. Goodness-of-fit is judged by inspection, as described previously.

(3) Because of the complexity of the log Pearson type III distribution, no single specialized plotting grid is practical for this graphical test. Instead, the log-normal grid is used to display data thought to be drawn from a log Pearson type III distribution. The fit is judged by

inspection. Figure 12-4 illustrates this. The observed peaks and plotting positions from columns 7 and 8 of Table 12-1 are plotted here. Quantiles computed with Equation 12-10 are plotted on the same grid. The estimated values of the terms of Equation 12-5 are $X = 3.3684$; $S = 0.2456$; and $G = 0.700$. The skew was adjusted here with a regional skew. The computed frequency curve fits well the plotted observations.

(4) Rigorous statistical tests permit quantitative judgement of goodness of fit. These tests compare the theoretical distribution with sample values of the relative frequency or cumulative frequency function. For example, the Kolmogorov-Smirnov test provides bounds within which every observation should lie if the sample actually is drawn from the assumed distribution. The test is conducted as follows (Haan 1977):

(a) For each observation in the sample, determine the relative exceedance frequency. This is given by m/N , where m = the number of observations in the sample greater than or equal to the observed magnitude, and N = the number of observations.

(b) For each magnitude in the sample, determine the theoretical exceedance frequency using the hypothesized model and the best estimates of the parameters.

(c) For each observation, compute the difference in the relative exceedance frequency and the theoretical exceedance frequency. Determine the maximum difference for the sample.

(d) Select an acceptable significance level. This is a measure of the probability that the sample is not drawn from the candidate distribution. Values of 0.05 and 0.01 are common. Determine the corresponding Kolmogorov-Smirnov test statistic. This statistic is a function of the sample size and the significance level. Test statistics are tabulated or can be computed with the following equation (Loucks, Stedinger, and Harth 1981):

$$C \left[n^{0.5} + 0.12 + \left(\frac{0.11}{N^{0.5}} \right) \right] \quad (12-14)$$

where:

$$C = 1.358 \text{ for significance level } 0.05$$

$$C = 1.628 \text{ for significance level } 0.01$$

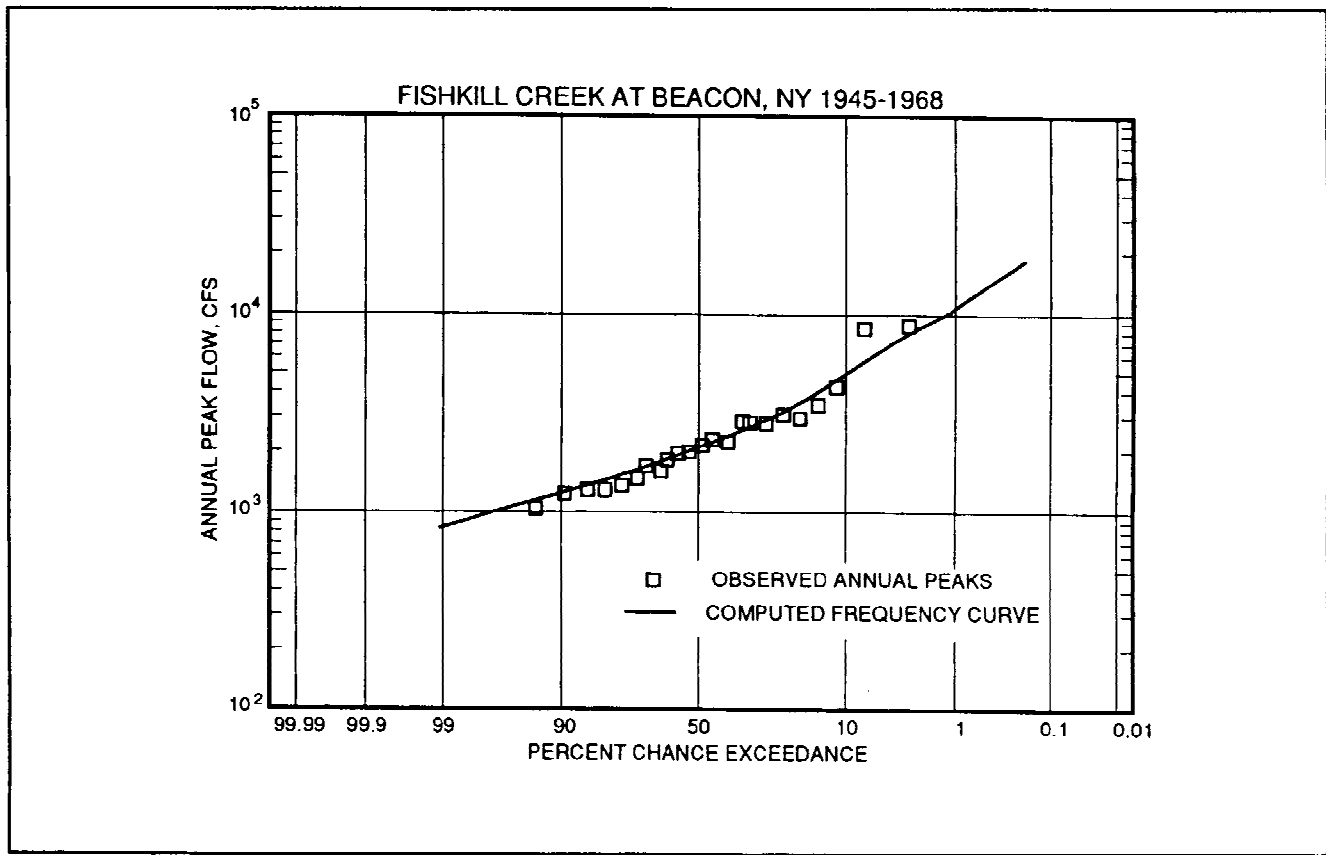

Figure 12-4. Plot for verification

(e) Compare the maximum difference determined in step c with the test statistic found in step d. If the value in step c exceeds the test statistic, the hypothesized distribution cannot be accepted with the specified significance level.

(5) The reliability of a computed frequency curve can be illustrated conveniently by confidence limits plotted on the frequency grid. Confidence limits are established considering the uncertainty in estimating population mean and standard deviation from a small sample. For convenience, Appendix 9 of Bulletin 17B (USWRC 1981) includes a table of frequency factors that permit definition of 1 percent to 99 percent confidence limits. These frequency factors are a function of specified exceedance probability and sample size. As the sample size increases, the limits narrow, indicating increased reliability.

(6) Figure 12-5 shows the 5 and 95 percent confidence limits for the Fishkill Creek frequency curve. The

probability is 0.05 that the true quantile for a selected exceedance probability will exceed the value shown on the 5 percent curve. The probability is 0.95 that the true quantile will exceed the 95 percent-curve value and only 0.05 that it will be less than the 95 percent curve.

12-5. Special Considerations

a. Mixed populations. In certain cases, observed streamflow is thought to be the result of two or more independent hydrometeorological conditions. The sample is referred to as a mixed-population sample. For example, the spring streamflow in the Sacramento River, CA, is the result of both rainfall and snowmelt. For these cases, the data are segregated by cause prior to analysis, if possible. Each set can be analyzed separately to determine the appropriate distribution and parameters. The resulting frequency curves are then combined using the following equation to determine probability of union:

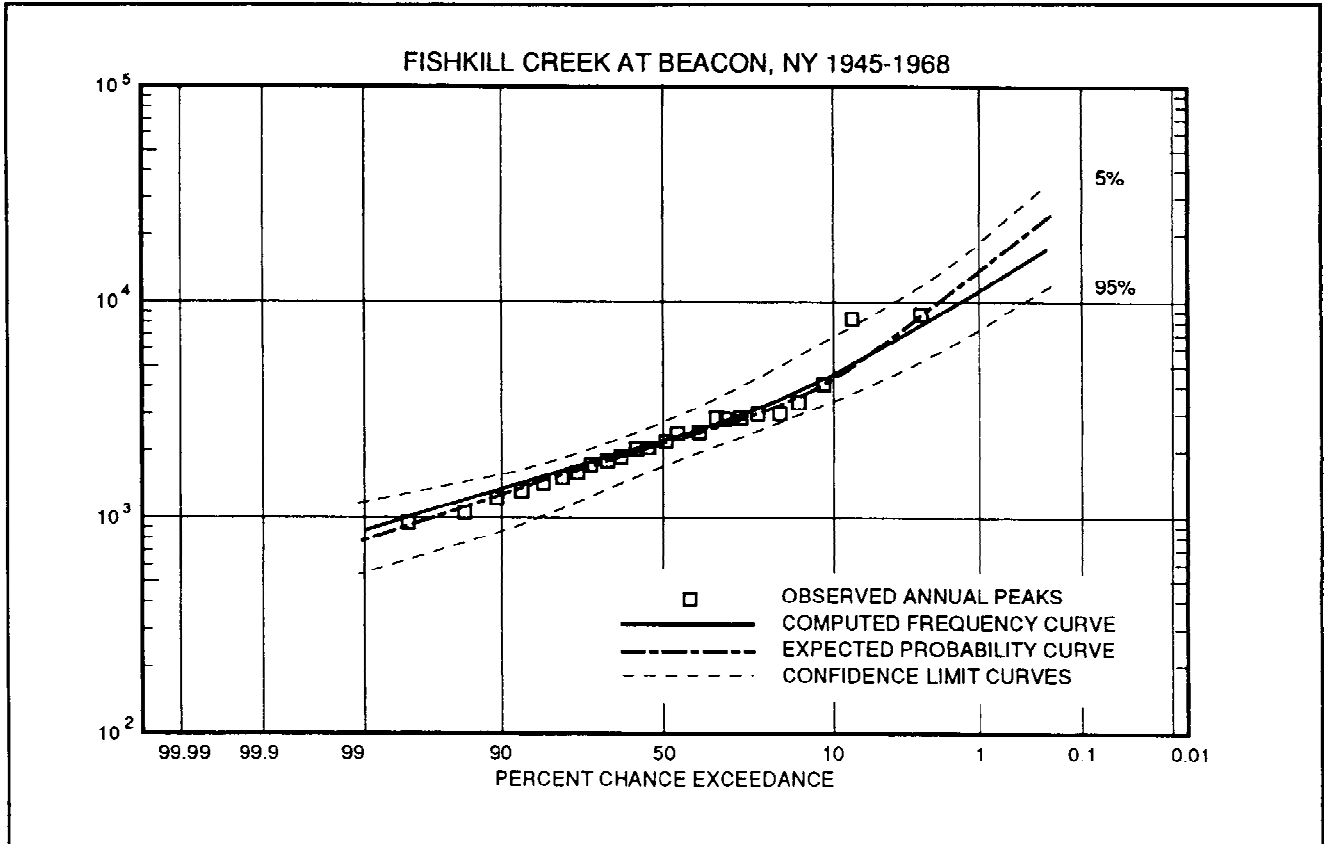

Figure 12-5. Frequency curve with confidence limits

$$P_c = P_1 + P_2 - P_1P_2 \quad (12-5)$$

where:

P_c = annual exceedance probability of combined populations for a selected quantile

P_1 = annual exceedance probability of same magnitude for sample 1

P_2 = annual exceedance probability of same magnitude for sample 2

This assumes that the series are independent. Otherwise, coincident frequency analysis must be used.

b. Coincident frequency analysis. In some planning, designing, or operating problems, the hydrometeorological event of interest is a function of two or more random hydrometeorological events.

(1) For example, discharge at the confluence of two streams is a function of the coincident discharge in the tributary streams. The objective of coincident frequency analysis is to estimate the frequency distribution of the result if the frequency distributions of the components are known. The specific technique used depends on the mathematical form of the function relating the variables. Benjamin and Cornell (1970) describe a variety of solutions, including analytical closed-form solutions and Monte Carlo simulation.

(2) In hydrologic engineering, the variable of interest often is the sum of components. In that case, the frequency distribution of the sum can be found through conditional probability concepts. For illustration, consider the total discharge downstream of a confluence, Q_T . This is computed as the sum of tributary discharge Q_1 and tributary discharge Q_2 . The frequency of Q_1 and Q_2 are established using procedures described previously. Roughly speaking, the probability that Q_T equals some

specified value, q_T , is proportional to the probability that Q_1 equals a specified value, q_1 , times a factor proportional to the probability that Q_2 equals $q_T - q_1$. This product is summed over all possible values of Q_1 . To develop a frequency curve for the sum, the process is repeated for all possible values of Q_T . Chapter 11 of EM 1110-2-1415 presents a detailed example of coincident frequency analysis.

c. Regional frequency analysis.

(1) Methods of frequency analysis described previously in this chapter apply to data collected at a single site. If a large sample is available at that site, the resulting frequency analysis may be sufficiently reliable for planning, designing, or operating civil-works projects. However, samples commonly are small. In fact, it is not unusual that risk information is required at sites for which no data are available. Regional frequency analysis techniques may be used to develop this information.

(2) Regional frequency analysis procedures relate parameters of a streamflow-frequency model to catchment characteristics. Briefly, the following general steps are followed to derive such a relationship:

(a) Select long-record sites within the region, and collect streamflow data for those sites.

(b) Select an appropriate distribution for the data, and estimate the parameters using the procedures described herein.

(c) Select catchment characteristics that should correlate with the parameters. Measure or observe these characteristics for the long-record sites. Typical characteristics for streamflow frequency model parameters

include the following: contributing drainage area, stream length, slope of catchment or main channel, surface storage, mean annual rainfall, number of rainy days annually, infiltration characteristics, and impervious area.

(d) Perform a regression analysis to establish predictive equations. The dependent variables in the equations are the frequency model parameters. The independent variables are the catchment characteristics.

(3) EM 1110-2-1415 provides additional guidance in establishing regional equations.

d. Frequency of other hydrometeorological phenomena. The procedures described for discharge-frequency analysis apply to analysis of other hydrometeorological phenomena. The same general steps presented in paragraph 12-4 are followed. For example, if the variable of interest is streamflow volume, rather than discharge, the time series will be a sequence of volumes for a specified duration. The procedures for selecting, calibrating, and verifying a frequency model are the same as previously described.

e. Volume-frequency and precipitation-depth-duration-frequency analyses. These analyses present some unique problems. Because of the small samples from which parameters must be estimated, the set of frequency curves for various durations may be inconsistent. For example, the 1-day volume should not exceed the 3-day volume for all probabilities. Yet, for a small sample, the computed curves may not follow this rule. To overcome this, the computed curves may be "smoothed," adjusted by inspection of plots. Alternatively, the statistical model parameters can be adjusted to maintain consistency. Paragraph 3-8c of EM 1110-2-1415 describes a typical procedure.

Chapter 13 Analysis of Storm Events

13-1. Introduction

This chapter is concerned with the application of event-type simulation models for flood-runoff analysis. Such models are commonly used with frequency-based hypothetical storms to develop discharge-frequency estimates or with standard project or probable maximum storms to develop associated flood estimates. The chapter begins with a discussion of initial development of a simulation model. This is followed by consideration of methods for calibration/verification of the model. Applications issues associated with design storms are the focus of the remainder of the chapter.

13-2. Model Development

Steps in the initial development of a simulation model are as follows: assess data requirements and availability; acquire and process data; develop subbasin configuration of model; and develop initial estimates for model parameters.

a. Assessment of data requirements and availability.

(1) It is essential that the model developer be fully aware of the study objectives and requirements, including the intended use of modeling products. Types of data required for model development include

- (a) historical precipitation and streamflow data;
- (b) runoff-parameter data from past studies;
- (c) data associated with watershed characteristics such as drainage areas, soil types, and land use;
- (d) characteristics of rivers and other drainage-system (natural or artificial) features; and
- (e) existence and characteristics of storage elements such as lakes, detention basins, etc.

(2) A field reconnaissance of the study basin should be performed. Information acquired from field observations can significantly enhance one's understanding of the runoff-response characteristics of the watershed and perhaps enable recognition of important watershed features that might otherwise be overlooked.

b. Acquisition and processing of data. Aspects of data management are treated in Chapter 17. Much precipitation and streamflow data are stored on electronic media, which can greatly facilitate data acquisition. It is generally desirable to place data in a data base and review it with graphics software. As the study proceeds, simulation results can also be stored in the data base, and utility software can be used to produce graphs, tables, etc. of key information. A careful review should be made of past studies and of the basis for all of the data being acquired.

c. Development of subbasin configuration.

(1) For most studies, it is necessary to divide a basin into subbasins to enable development of information at locations of interest and to better represent spatially variable runoff characteristics. A subbasin outlet should be located:

- (a) at each stream location where discharge estimates are required,
- (b) at each stream gauge, and
- (c) at dams and other significant hydraulic structures.

(2) Nondistributed models use lumped (spatially averaged) values for precipitation and loss (infiltration) parameters. Subbasins should be sufficiently small so that spatial-averaging of this information is reasonable. Basin subdivision may also be performed to tailor rainfall-runoff transformations to particular land-use conditions. For example, rural and urban portions of a basin might be represented separately. If flood-damage or other model-dependent analyses are to be performed, subbasin delineation should be coordinated with the users of model results. There may be reasons other than hydrologic that affect the choice of locations of subbasin outlets.

d. Development of initial estimates for parameter values.

(1) After defining the subbasin configuration, a skeleton input file can be developed which contains all required information (such as drainage areas, subbasin linkages, etc.) except values for runoff parameters. Such parameters might be required for defining unit hydrograph, kinematic wave, loss-rate, base-flow, or routing relationships. At this point, initial estimates of values for runoff parameters can be made and entered into the input file. Estimates can be derived from

- (a) past studies,
 - (b) application of previously developed regional relationships, and
 - (c) physical characteristics of the subbasins.
- (2) If there were no streamflow data available for the basin, there may be little basis for improving the initial estimates. However, generally, there are some streamflow data for locations in or near the basin which can be used in a calibration process to improve the initial estimates.

13-3. Model Calibration

Calibration here refers to the process of using historical precipitation and streamflow data to develop values for runoff parameters. Verification refers to the testing of calibrated values, generally with data not used for calibration. Topics in this section pertain to calibration strategy, selection of historical events, calibration techniques, and model verification.

a. Calibration strategy. Calibration of simulation models must be done carefully with due consideration for the reliability of historical data and for the simplistic nature of model components used to represent complex physical processes in heterogeneous basins. The insight that an experienced analyst brings to bear in accommodating these factors is, in many cases, the single most important element of the calibration process.

(1) The calculation of a discharge hydrograph at a location in a basin may be a function of few or many runoff parameters. A headwater subbasin is one for which there are no subbasins upstream. The simulation of runoff from a headwater subbasin is a function of parameters associated solely with that subbasin. Calculated runoff for the outlet of a downstream subbasin is a function not only of the parameters of the subbasin, but also of those for all upstream subbasins and routing reaches. For this reason, the calibration of values of parameters for gauged headwater subbasins is often more direct and reliable than calibration associated with downstream gauges.

(2) In a multisubbasin model, subbasins with stream-gauges at the outlet are generally a small proportion of the total number of subbasins. Hence, the general approach is to first calibrate parameter values for all gauged headwater subbasins and to use the results as an aid in setting or adjusting values for all other subbasins. The next (and generally most difficult) step is to review

calculated versus simulated results at all downstream gauges and to manually adjust key parameter values to provide basin-wide simulations that are as reasonable and consistent as possible.

b. Selection of historical events. Model components that employ unit hydrographs or other linear entities produce outputs proportional to inputs. Because watersheds do not respond in a truly linear manner, the events chosen for calibration and verification should, if possible, be consistent in magnitude with the magnitude of hypothetical events to which the model will be applied. In many cases, this is not feasible because the hypothetical events are more rare than those that have been experienced historically. Nevertheless, the largest historical events for which data are available generally provide the best basis for calibration/verification.

(1) In addition to the size of a historical event, the state of the basin at the time of occurrence is significant. The model must represent land-use and other conditions consistent with the time of occurrence of the historical event. If existing basin conditions are of primary interest and a historical event occurred when the basin conditions were markedly different, the event may be of little value for calibration.

(2) Also important are the amount and quality of data associated with historical events. If precipitation data are lacking or if only daily values are available and a model with small subbasins is being calibrated, an event may be of limited value for calibration.

(3) In general, it is desirable to use several events (say, four to six) for calibration. It is also desirable to reserve a couple of events for verification. Sometimes the amount of useful data is limited so that there are few events for calibration and no events for verification.

c. Calibration techniques for gauged headwater basins. Computer software can be used for automated calibration of parameter values for gauged headwater subbasins. Figure 7-7 shows in simple terms the procedure that may be used. As may be noted, it is necessary to specify initial values for the parameters to be optimized. The simulation is performed with these values and the results compared with the observed discharge hydrograph. The quantitative measure of goodness of fit, the *objective function*, is often defined in terms of a root mean square error, where error is the difference between computed and observed discharge ordinates. For flood-runoff analysis, the errors may be weighted with a function that gives more weight to higher flows than

lower flows, as illustrated in Equation 7-18 in paragraph 7-3e.

(1) Parameter values are adjusted in automatic calibration to minimize the magnitude of the objective function. Because of interdependence between parameters and other factors, a global minimum is not always achieved, which results in suboptimal values for parameters. Another aspect of calibration is that constraints on acceptable parameter values are often imposed. For example, negative loss rates would be unreasonable. Parameter values obtained by calibration should be reviewed carefully; values that are unreasonable or inconsistent should be rejected. Generally, the quality of fit between the observed and computed hydrographs is best judged by reviewing plots of the hydrographs and associated rainfall and rainfall-excess hydrographs, rather than simply looking at statistical measures of the fit.

(2) The analyst should thoroughly understand the optimization procedure being implemented and have sufficient output information to enable verification of its performance. Suboptimal results can sometimes be improved by reoptimization with different initial conditions, restricting the optimization region, or other means.

(3) The parameter values optimized for each historical event will be unique. Criteria are required for choosing a single set of values to represent the runoff characteristics of the subbasin. Consideration should be given to factors such as

(a) the quality of fit between the observed and computed hydrographs,

(b) the magnitude of the event, and

(c) the quality of the precipitation and streamflow data for the event.

Generally, estimates based on the larger events would be given more weight if the calibrated model is intended for application to rare events. Once a set of parameter values has been adopted, the historical events should be rerun with these values. Further refinement may be needed to achieve the best compromise in matching available data.

d. Calibration techniques for downstream gauges. The calibration process for downstream locations involves simulating runoff at each streamgauge and ascertaining what parameter-value adjustments, if any, should be made for upstream subbasins and/or routing reaches. The calibration should be performed starting at the upstream

gauges and working downstream. Adjustments should generally not be tailored to any one event. Rather, the model performance should be judged for all calibration events. When a consistent bias is noted, for example if the timing of runoff is consistently too early or too late, the most likely cause of the bias should be sought and the model adjusted accordingly. Often, poor results are due to erroneous definition of precipitation or other data problems. If the problems cannot be reconciled, the data should be rejected for calibration purposes. Numerous simulations may be required to determine a final set of parameter values that are most reasonably consistent with knowledge of the basin and the data associated with the calibration events.

e. Verification. Verification enables assessment of the reliability of the calibrated model. It is performed by simulating historical events not used for calibration. With an event-type model, there is always uncertainty associated with loss rates, and they are critical in their impact on runoff volumes. For purposes of verification, the antecedent rainfall-runoff conditions should be assessed and loss rates chosen that are consistent with similar antecedent conditions associated with calibration events. Adjustment of the loss rates may be required to obtain reasonable agreement with the observed runoff volumes. Once this agreement has been achieved, a critical assessment of the simulated results can be made. Good agreement between simulated and observed hydrographs engenders confidence in the model performance, at least for events similar in magnitude to those simulated. If results are poor, reasons for such results should be ascertained, if possible. Parameter-value modifications required to produce reasonable simulations of the verification events should be determined. If such modifications can be made without significant degradation of the results obtained for the calibration events, the modifications can be adopted. If degradation of calibration results would occur, it may be appropriate to redo the calibration with incorporation of the verification events. In either case, the poor results are cause for associating a higher level of uncertainty with model application.

13-4. Simulation of Frequency-Based Design Floods

Event-type models are commonly used with frequency-based hypothetical storms for the development of discharge-frequency estimates. Issues discussed in this section include design-storm definition, depth-area adjustments, and association of runoff frequency with rainfall frequency. Other issues such as transfer of frequency information from gauged to ungauged locations,

conversion of nonstationary to stationary peak discharges, and development of future-condition frequency estimates are discussed in Chapter 17.

a. Design-storm definition.

(1) The NOAA has published generalized rainfall criteria for the United States. Appendix A lists a number of these publications. The criteria consist of maps with isopluvial lines of point precipitation for various frequencies and durations. Generally, the maps for mountainous regions are substantially more detailed because of orographic effects.

(2) The rainfall depths obtained from NOAA criteria are point values commonly assumed to apply up to 10 square miles. For larger areas, the average precipitation over the area is less than the value for a point, and adjustments are required. Figure 13-1 shows adjustment criteria provided in NOAA publications.

(3) The rainfall depths from NOAA criteria are based on a *partial duration series*. If value of the annual series is desired, adjustment factors are applied to recurrence intervals of 10 years or less. No adjustment is applied for larger recurrence intervals larger than 10 years, as the two series essentially merge at that recurrence interval.

(4) The NOAA criteria do not contain specific guidance for establishing the temporal distribution of design-storm rainfall. A common approach is to arrange the rainfall to form a *balanced* hyetograph; that is, the depth associated with each duration interval of the storm satisfies the relation between depth and duration for a given frequency. For example, for a 1 percent-chance (100-year) 24-hr storm, the depths for the peak 30-min, 1-hr, 2-hr, ..., 24-hr durations would each equal the 1 percent-chance depth for that duration. Although such storms do not preserve the random character of natural storms, use of a balanced storm ensures an appropriate depth (in terms of frequency), regardless of the time-response characteristics of a particular river basin.

(5) The SCS has developed four 24-hr synthetic rainfall distributions (USDA 1986) from available National Weather Service duration-frequency data. Types I and IA represent the Pacific maritime climate with wet winters and dry summers. Type III represents Gulf of Mexico and Atlantic coastal areas where tropical storms bring large 24-hr rainfall amounts. Type II represents the rest of the country. Other approaches for defining the temporal distribution of design storms are reported in the

literature. If none of the synthetic distributions are applicable to the area being modeled, the hydrologist should look at historical information, as well as regional data, to develop an adequate temporal distribution.

b. Depth-area considerations.

(1) The area-adjustment criteria of Figure 13-1 have a nonlinear effect on storm hyetographs. That is, a balanced hyetograph for one storm size is not a simple proportion of a balanced hyetograph for a different storm size. Each storm size will have its own unique depth and temporal distribution. This creates a problem in situations where it is desired to develop a consistent set of frequency estimates for numerous sites in a basin. It would be necessary to develop a unique storm hyetograph for every location. For a basin with many subbasins and stream junctions, the computational requirements could be substantial.

(2) An approach for dealing with this situation is based on calculating *index* discharge hydrographs at each location of interest from a set of *index* hyetographs for storm areas that encompass the full range of drainage areas from the area of the smallest subbasin to the total basin area. The hydrograph for a given location is obtained by interpolating, based on drainage area, between two index hydrographs for that location. This is illustrated in Figure 13-2.

(3) A semi-logarithmic interpolation equation (used in computer program HEC-1) is as follows:

$$Q = Q1 \left(\frac{\log \frac{A2}{Ax}}{\log \frac{A2}{A1}} \right) + Q2 \left(\frac{\log \frac{Ax}{A1}}{\log \frac{A2}{A1}} \right) \quad (13-1)$$

where

Q = instantaneous discharge for the interpolated hydrograph

Ax = drainage area represented by the interpolated hydrograph

$A1$ = index drainage area that is closest to, but smaller than, Ax

$A2$ = index hydrograph closest to, but larger than, Ax

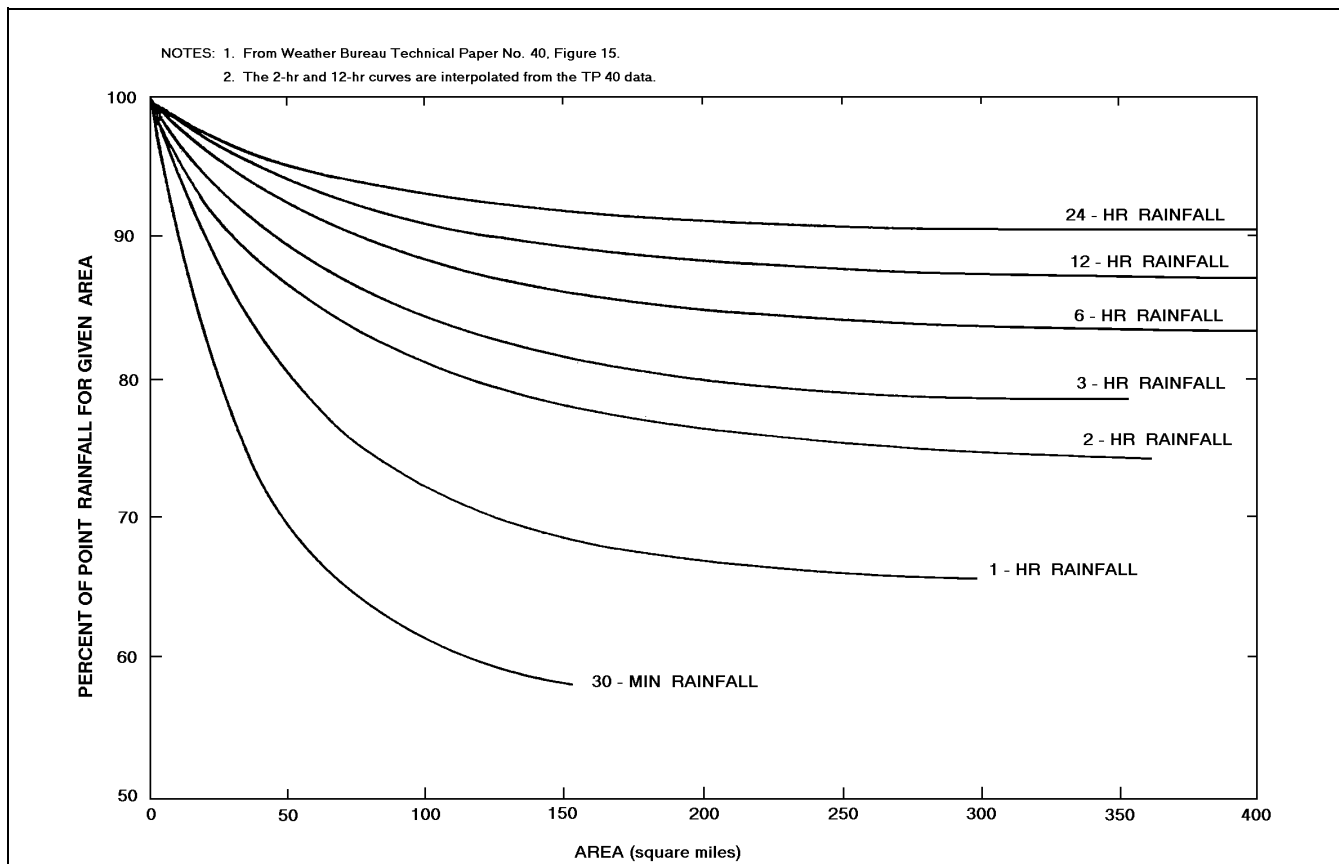

Figure 13-1. Area-adjustment of point rainfall

Q_1 = instantaneous discharge for the index hydrograph corresponding to A_1

Q_2 = instantaneous discharge for the index hydrograph corresponding to A_2

An illustration of this approach is given in the HEC-1 User's Manual.

c. *Association of runoff frequency with rainfall frequency.* Although the NOAA rainfall criteria associate frequency with depth, it does not follow that the same frequencies should be associated with the design storms or the calculated flood-runoff.

(1) In addition to rainfall, runoff is a function of loss rates and base flow, the magnitudes of which vary with time and antecedent moisture conditions. A very dry antecedent condition associated with a 100-year storm might produce runoff with a significantly smaller recurrence interval.

(2) Because of the uncertainty of the frequency of design-storm runoff, it is best to utilize statistically based frequency information (for locations with at least 10 years of streamflow data) wherever possible to 'calibrate' the exceedance frequency to associate with particular combinations of design storms and loss rates. This important concept is discussed further in Chapter 17.

13-5. Simulation of Standard Project and Probable Maximum Floods

Standard project and probable maximum floods are used as design events and also as reference events for comparison with flood magnitudes developed by other means. They are generally developed by simulation (with an event-type model) of runoff from design storms. The events represent very rare occurrences, generally well beyond the range of events for which reliable frequency estimates (from statistically based frequency curves) could be made. This section defines each design flood and discusses issues associated with their derivation.

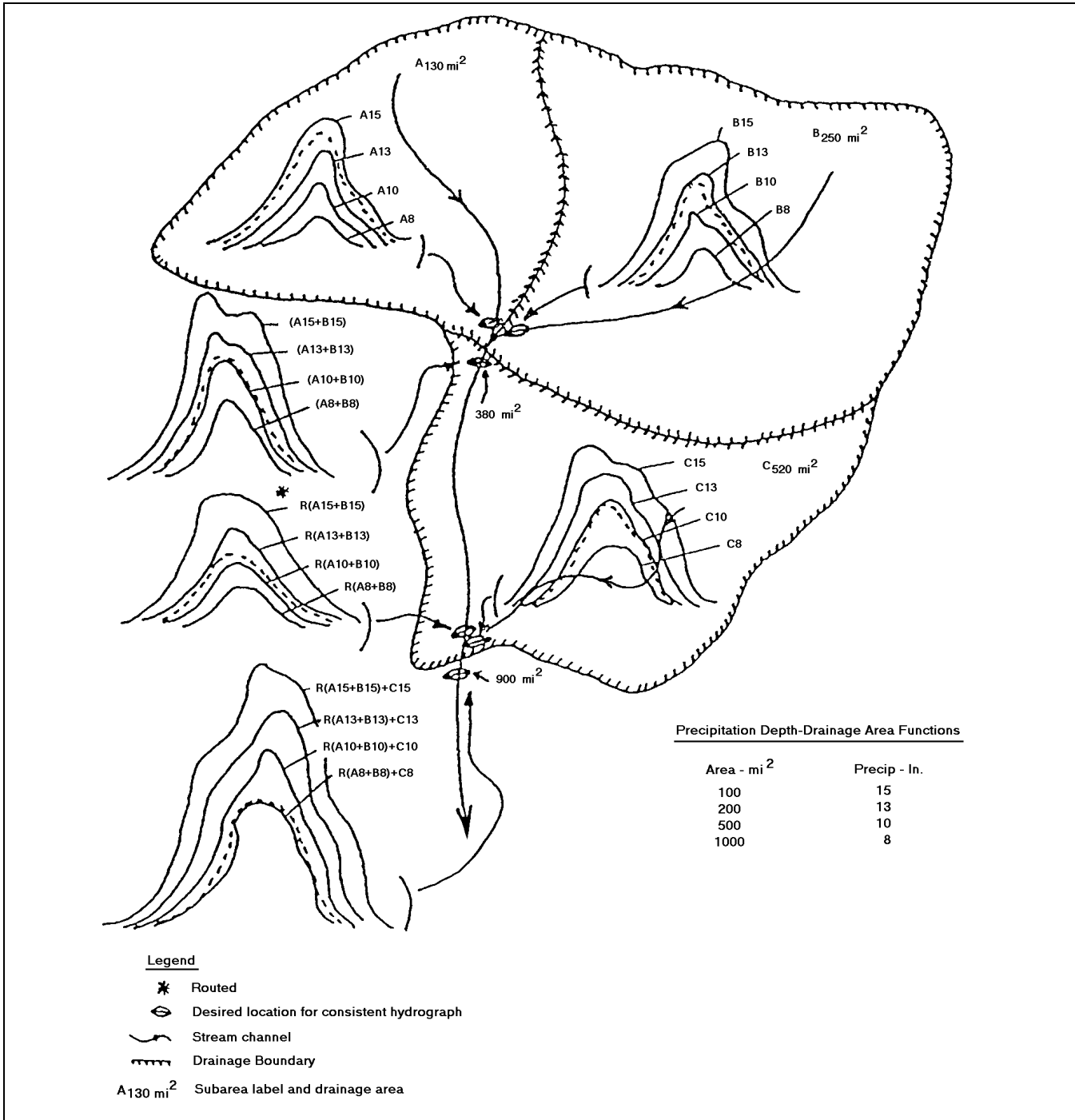

Figure 13-2. Index and interpolated hydrographs

a. *Standard project flood.* The standard project flood (SPF) is the flood that can be expected from the most severe combination of meteorologic and hydrologic conditions that are considered *reasonably characteristic* of the region in which the study basin is located. The SPF is generally based on analysis (and transposition) of major storms that have occurred in the region and selection of a storm magnitude and temporal distribution that is as severe as any of the transposed storms, with the possible exception of any storm or storms that are exceptionally larger than others and are considered to be extremely rare. Studies compiled in the United States indicate that SPF peak discharges are usually of the order of 40 to 60 percent of probable maximum peak discharges.

(1) The SPF is intended as a practicable expression of the degree of protection to be considered for situations where protection of human life and high-valued property is required, such as for an urban levee or floodwall. It also provides a basis of comparison with the recommended protection for a given project. Although a specific frequency cannot be assigned to the SPF, a return period of a few hundred to a few thousand years is commonly associated with it.

(2) Because the standard project storm (SPS) is not widely used outside the USACE, only a limited number of publications describe its derivation and use. EM 1110-2-1411 describes SPS derivation for the United States east of the 105° longitude. Computer program HEC-1 contains an option for automatically applying this criteria. SPS development for the remainder of the United States is based on various published and unpublished Corps reports and procedures. Sometimes the SPF is developed as a proportion (e.g., 50 percent) of the probable maximum flood.

(3) Associated with SPF simulation is the choice of loss rate and base flow parameter values and perhaps antecedent snowpack and related information. Loss rates and base flow should be commensurate with values considered reasonably likely to occur during storms of such magnitude. They should be estimated on the basis of rates observed in floods that have occurred in the basin or in similar areas. EM 1110-2-1406 is a source of information relating to snowpack and snowmelt assumptions to associate with an SPF.

b. *Probable maximum flood.* The probable maximum flood (PMF) is the flood that may be expected from the most severe combination of critical meteorologic and hydrologic conditions that are *reasonably possible* in the region. It is used in the design of projects for which

virtually complete security from flood-induced failure is desired. Examples are the design of dam height and spillway size for major dams and protection works for nuclear power plants.

(1) The PMF is calculated from a probable maximum storm (PMS), generally with an event-type model. The PMS is based on probable maximum precipitation (PMP), criteria developed by the Hydrometeorological Branch of the Office of Hydrology, NWS. Figure 13-3 shows regions of the contiguous United States for which generalized PMP criteria have been developed. The hydrometeorological reports shown in the figure are listed in the references. Hydrometeorological Report (HMR) No. 52 (U.S. Department of Commerce 1982) provides criteria for developing a PMS based on PMP criteria from Reports No. 51 and 55 (U.S. Department of Commerce 1978 and 1988) (for the United States east of longitude 105°). A computer program (USACE 1984b) has been developed to apply the criteria in Report No. 52. Hydrometeorological criteria are being updated for various areas of the country. A check should be made for the most recently available criteria prior to performing a study. In regions where there are strong orographic influences, it is sometimes desirable for basin-specific criteria to be developed. Such studies require considerable time and dollar resource commitments, and their need should be well established. The Hydrometeorological Branch of the NWS is partially funded by the USACE and is available to serve in a consulting capacity.

(2) The technical basis for PMP estimation is described in the various hydrometeorological reports. NOAA Technical Report NWS 25 contains maps indicating storms of record that produced rainfall within 50 percent of PMP. (Other maps show the ratio of point PMP to 100-year values.) Such information shows that PMP values are consistent with reasonable extrapolation of the major storms of record; in some cases, the extrapolation is less than about 10 percent.

(3) Ground conditions that affect losses during the PMS should be the most severe that can reasonably exist in conjunction with such an event. The lowest loss rates that have been developed for historical storms might be used if there is reasonable assurance that such storms represent severe conditions. Where it is possible for the ground to be frozen at the start of a rain flood or snowmelt flood, it can be concluded that zero or near-zero loss rates should be used. If there is a seasonal variation in minimum loss rates, the values selected should be representative of extreme conditions for the season for which the PMF is being developed.

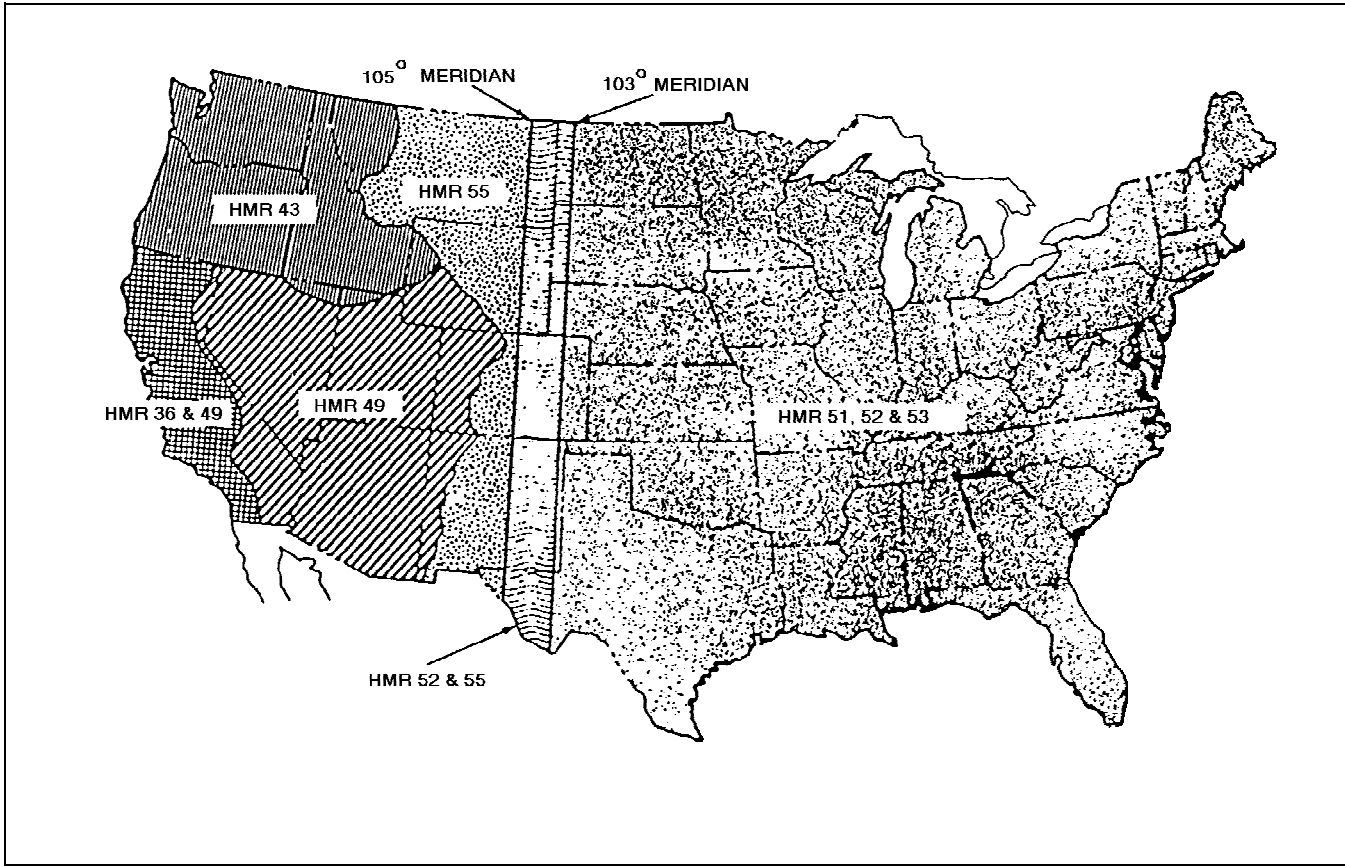

Figure 13-3. Regions covered by generalized PMP studies

(4) For situations where snowpack/snowmelt is a factor, it is generally not feasible to compute maximum snowpack accumulation from winter precipitation, temperature, and snowmelt losses. Rather, a probable maximum snowpack for floods that are primarily snowmelt floods can be estimated by extrapolation of historical snowpack data. In the case of rain floods that have some snowmelt contribution, snowpack used for probable maximum rain-flood computation should be the maximum that can contribute to the peak flow and runoff volume of the flood without inhibiting the direct runoff from rainfall. The critical snowpack in mountainous regions will ordinarily be located at elevations where most of the rain-flood runoff originates. Snowpack is ordinarily greater at higher elevations and less at lower elevations, and hence critical snowpack will not exist at all elevations. Factors to be considered in selecting temperature sequences for snowmelt simulation are discussed in EM 1110-2-1406.

(5) Runoff parameter values used for the transformation of rainfall/snowmelt to runoff should be appropriate

for the magnitude of the event being simulated. Travel times tend to be significantly shorter during major events. Indices of travel time, such as values for unit hydrograph parameters and routing coefficients, are frequently adjusted downward from their magnitudes based on historical events to reflect the severe conditions. In applications for spillway design, allowance should be made for the acceleration effect of a reservoir in relation to the stream reaches that are inundated.

(6) In spillway design applications, flood conditions that precede the PMF may have substantial influence on the regulatory effect of the reservoir. In such cases, it is appropriate to precede the PMF with a flood of major magnitude at a time interval that is consistent with the causative meteorological conditions. While a special meteorological study is desirable for this purpose, it is often assumed that the PMF is preceded by a SPF 4 or 5 days earlier.

Chapter 14

Period-of-Record Analysis

14-1. General

Period-of-record analysis is seeing increasing interest and usage due to the continuing decrease in the costs of computer processing and the increased availability of hydrologic models with continuous simulation capability. As used in this document for flood-runoff analysis, period-of-record analysis refers to applying a precipitation-runoff model to simulate a continuous period of record of streamflow, including the detailed simulation of flood events. This method requires a relatively sophisticated hydrologic model capable of simulating throughout the hydrologic cycle; it implies a more complete model calibration effort; and, it requires extensive data and data processing. Because of these factors, it is not an inexpensive approach to flood-runoff analysis and therefore not an economical application in many situations. However, certain engineering applications, e.g., the detailed evaluation of the effects of urbanization in a basin, are readily suited to this type of analysis.

14-2. Simulation Requirements

Because period-of-record analysis requires the continuous and detailed simulation of stream flow from precipitation, additional modeling requirements are required beyond those normally associated with the simulation of discrete storm events. Previous chapters in Part II of this manual have described the processes associated with individual flood analysis, including precipitation/runoff transformation and routing techniques. These techniques are also applicable to continuous simulation. Beyond these, however, are several additional factors that must be treated in a continuous modelling effort, summarized as follows:

- a. Evapotranspiration.
- b. Lake and reservoir evaporation.
- c. Long-term subsurface simulation.
- d. Distributed watershed formulation.
- e. Interception.
- f. Data processing requirements.

These factors were described in detail in Chapter 8.

14-3. Model Calibration

The process of deriving characteristics, equation constants, weighting factors, and other parameters that serve to define the model for a particular watershed is termed "calibration." (Strictly speaking, "calibration" is distinguished from "verification," as described below.) In continuous simulation, the calibration process is generally more rigorous and complex than is model development for discrete storm analysis, in that more parameters are usually involved in a continuous model; a much greater amount of hydrometeorological data is involved; the fitting of the model requires a greater number of hydrologic factors (i.e., short- and long-term volumes, year-to-year carryover of volume, low-flow streamflow reproduction--as well as peak flow and flood-runoff timing); and more rigorous statistical procedures are usually employed to ensure that an unbiased fitting of the model is achieved.

a. Calibration process. The following is an outline of the steps typically followed in calibrating a continuous simulation model.

(1) Data development. The data base development for the model can be a time-consuming process, requiring careful attention. Although digital sources now exist for easy downloading of streamflow, precipitation, temperature, and snow data, these sources may not include an adequate frequency of observations. For example, a small basin may require hourly observations, for satisfactory simulation, that are not readily available from common data sources. Calibration of a continuous simulation model typically employs from 5 to 30 or more years of continuous records, so the data processing task is relatively large if a frequent timestep is required. The presence of poor quality data can be a problem. Prechecking the data by such techniques as graphics display or by double-mass curve analysis and other station cross-checking procedures is desirable. The use of a data management system such as HECDSS is useful in this regard.

(2) Station selection. The choice of which precipitation and temperature stations best represent the basin-wide meteorological input might take several iterations through the entire calibration process. However, reasonably appropriate choices can be made prior to calibration through intuitive inspection of station location and characteristics, use of normal annual isohyetal maps, simple correlations of precipitation with runoff, etc.

(3) Initial model parameters. The initial choice of model parameters is not a critical concern since adjustments will be made during calibration. However, those parameters that have physical relevance should be determined to reduce the possibilities for future adjustment as the calibration proceeds. Table 14-1 lists the model parameters that are typically encountered in continuous simulation models and indicates those factors that can be determined by independent analysis. For other parameters that need to be empirically determined, the initial value might be based upon known factors in previous simulation studies, by examples given in user manuals, or by default values in the computer program.

(4) Water balance. A desirable, if not essential, part of the calibration process is to make an independent estimate of the basin's water balance. This calculation would yield annual, or perhaps monthly, estimates of basin precipitation, evapotranspiration, and soil moisture that can be helpful in calibrating the model.

(5) Parameter adjustment. Trial simulation runs are made and model output is compared with observed streamflow and runoff data as described in paragraph 13-3. Based upon those comparisons, parameter adjustments are then made to improve the fit of the model. This process requires an experienced and knowledgeable person, both in the use of the model and understanding basic hydrologic principles. Adjustments are made first to those factors which have the greatest impact on the model fit, then proceeding to variables with lesser sensitivity. The process may be expressed as three basic steps (each having several trials) as follows:

(a) Achieve fit of runoff volumes throughout the year (monthly water balance). This process primarily involves adjustment of precipitation weighting, loss-rate functions, and evapotranspiration factors. Calibration fit is usually judged by comparing monthly and annual runoff volumes.

(b) Develop hydrograph shape. This step involves working with runoff distribution and routing factors, particularly in the lower-zone components. If snow is a factor, then temperature and snow accumulation/ablation factors may need to be adjusted.

(c) Refine hydrograph fit. This final step involves working with surface runoff factors and other parameters to refine the hydrograph shape.

(6) Table 14-1 describes this priority order in more detail and gives relative sensitivity of the variables. Most

of the parameters in a continuous simulation model represent a physical process. It is imperative that parameter values remain physically reasonable throughout the calibration process to keep the fit from being a local optimization that will not work when extrapolated to new data. The verification step described below is highly desirable to ensure that the fit is a general solution, not one unique only to the calibration data used.

b. Calibration comparison tools. Continuous simulation models use and create an immense amount of data, particularly if a long period of record is involved. Judging the fit of the final streamflow output alone is difficult, but reviewing the intermediate output such as soil moisture levels, snow pack, and runoff component hydrographs, makes the task more difficult. Accordingly, it is almost mandatory that special techniques be employed to facilitate comparisons of calibration runs and make model adjustments. These techniques are preferably built into the computer program being utilized. The following are examples of tools that are typically employed:

(1) Tabular summaries:

(a) Monthly and annual volume summaries in units of runoff volume and in inches.

(b) Summary tabulations of model internal computations.

(2) Graphical displays:

(a) Hydrographs of observed and computed streamflow.

(b) Hydrographs of model internal component output (e.g., soil moisture, subsurface flow).

(c) Flow-duration curves, observed and computed streamflow.

(d) Scatter-plots, monthly runoff volumes.

(e) Period residuals (observed - computed flow) or accumulated errors versus time.

(3) Statistical calculations:

(a) Statistical summaries of monthly volumes.

(b) Root-mean square error of period deviations (computed minus observed).

**Table 14-1
Model Calibration - Parameter Sensitivity**

<u>Parameter</u>	<u>Relative Sensitivity</u>	<u>Major Effects</u>	<u>Principal Calib. Tool</u>	<u>Calibration Priority</u>	<u>Independent Evaluation</u>	<u>Physical Attribute/ Connection</u>
Precipitation/Temperature						
Precipitation station weight	H	V	X	1	X	Thiessen Polygon/NAP Map
Temperature station adjustment	M	S		2	X	Station data/observed flows
Elevation distribution of precipitation	M	V		2	X	NAP Map
Evapotranspiration function	M	V		1	X	Observed evap.; empirical formulas
Intercept function	L	V		1	X	Maps (vegetation cover)
Lapse rate	M	S		2	X	Theoretical, observed temperature
Snow						
Melt-rate factor change	M	S	X	2		
Snow conditioning	L	S		3	X	Theoretical, observed equations
Runoff Distribution						
Precipitation excess function	H	V	X	1		
Lowest zone distribution	L	S		1		Soil maps, observed flows
Base flow distribution	H	S	X	2		
Subsurface/surface distribution	M	S		2		
Routing Function						
Lowest zone	L	S		2		
Baseflow	M	S	X	2		
Subsurface flow	H	S	X	3		
Surface flow	H	S	X	3		
Initial Conditions						
Snow water equivalent	L	V		1	X	Snowpack readings
Snow condition	L	S		1	X	Snowpack readings
Soil moisture	L	S		1	X	Observed flows, observed precip.
Base flow	L	S		1	X	Observed flows
Surface flow	L	S		1	X	Observed flows
Legend:						
	L=Low	V=Volume		1=Water balance		
	M=Medium	S=Hydrog shape		2=Hydrog shape		
	H=High			3=Refined fit		

COMMENTS

- "Relative Sensitivity" indicates degree to which parameter affects model output.
- "Major Effects" indicates which aspect of the output is primarily affected.
- "Principle Calibration Tool" indicates which parameters are usually adjusted to achieve first-cut calibration.
- "Calibration Priority" suggests the order in which parameters are typically adjusted.
- "Independent Evaluation" indicates those parameters that are typically determined independent of the calibration process, because they are more physically based. Adjustments may be required, however, in fine-tuning the model.

c. Verification. After calibration of the model is complete, it is good practice to then simulate an independent period of record and compare the results with observed data. This procedure will help to ensure that the calibration is not unique and limited to the data set employed for calibration.

14-4. Applications

It is important in approaching a possible application of period-of-record analysis to be certain that it is a necessary and appropriate approach to solving the problem, since the commitment of time and resources is relatively high. On the other hand, this type of analysis is available as a potentially powerful tool in hydrologic analysis and forecasting for types of applications that may not be obvious. To assist in the decision-making on applications, and for providing references if similar studies are undertaken, the following actual and potential applications are described:

a. Extension of streamflow records. In situations where weather records in a basin have a longer period of record than streamflow stations, continuous simulation would be a logical method of extending a record of streamflow, particularly if a continuous flow record is desired (as opposed to, say, just peak flows). The model used would be calibrated and verified on the observed data and extended as meteorological data permit.

b. Derivation of ungauged streamflow records. This application is quite feasible and has been utilized in the profession. Since the effort involved is not small, it is likely that it would not be used in ordinary planning investigations but might be appropriate for special situations, e.g., cases with legal or controversial ramifications. The method relies on the fact that most likely adjacent basins will have similar subterranean characteristics, so that if a detailed simulation model is developed on a basin with streamflow data, subsurface and groundwater characteristics can be transferred to the ungauged basin with a relatively high degree of confidence. Surface characteristics also can be based upon the gauged basin but are likely to be modified as necessary by observable factors such as slope, terrain, etc.

c. Analysis of basin modifications. The assessment of urbanization effects and other changes in the physical

characteristics of a river basin are quite well suited to period-of-record analysis with a continuous simulation model. The model can be calibrated by relating observed physical conditions (past records might likely exist reflecting either no development or partial development) to observed hydrometeorological data. Then, the period of record of hydrometeorological data can be simulated utilizing the observed or forecasted physical conditions to be evaluated. The resulting flows will be a large sample of data for statistical representation, reflecting a consistent level of basin development. The model used in this type of analysis would have to be capable of representing the physical changes involved; i.e., increase in impervious area, changes in runoff response, etc.

d. Interior runoff analysis. A stochastic analysis may be required in the planning and design of interior drainage facilities for leveed areas, particularly when the relative timing and magnitude of the main river and the interior runoff are important in determining the economics of the project. Although the main river would likely have an adequate record of streamflow data, most interior drainage areas do not. By using continuous simulation, the rainfall-runoff calculation required for the interior area can be performed and conveniently joined with the main channel streamflow, which would either be derived by the rain-runoff model or based upon observed streamflow data.

e. Long-term runoff forecasting. Continuous simulation has been used to produce long-term forecasts of streamflow for operational purposes. In a technique called "extended streamflow prediction" (ESP), the NWS and others have combined period-of-record weather records for a given future period of up to several months with current basin hydrologic conditions to produce a statistical representation of future conditions. The procedure is best suited for the Western interior river basins with large winter snowpacks, where a snowpack in January plays a relatively large role in determining runoff in May and June. The statistical analysis produced by the period-of-record simulation reflects the variations in subsequent precipitation and temperature combined with the current snow conditions. Successive forecasts made as springtime approaches have less and less variance.

PART IV
ENGINEERING APPLICATIONS

Chapter 15 Data Collection and Management

15-1. General

a. Water resource studies tend to be data intensive. One reason is that the physical systems involved are often large and complex (e.g., watersheds, precipitation fields, river-reservoir systems, etc.), and substantial quantities of data are required for their representation. Another reason is that the investigations themselves are complex, with a variety of interdependent computational elements (e.g., precipitation-runoff simulation, and statistical, systems, and economic analyses, etc.). The transfer of data generated with one element to another is a significant requirement in such investigations.

b. The acquisition, processing, and management of data can require a substantial portion of the resources allotted for an investigation. Performance of these tasks in an efficient and reliable manner can be of considerable value. This chapter describes aspects of data management.

15-2. Data Management Concepts

a. Figure 15-1 illustrates components of a data management system for a water resource study. Elements of the system include a data loading module for entering data from various sources into the management system, "application" programs that read information from and write information to data storage, and utility programs that perform functions such as data editing, displaying data in graphical and tabular form, and mathematical transformations of data. With such a system, basic data can be loaded into storage, reviewed, and perhaps edited with utility programs. Interdependent application programs can be used to perform the analysis, using the data storage to pass information generated with one program to the next. Utility programs can be used to prepare summaries of results in various forms, including report-quality tables and graphs.

b. Common data types for flood-runoff analysis include individual element, time series, and paired function. Individual element data include items such as basin properties (e.g., drainage area, percent imperviousness, soil types), values for runoff parameters (e.g., unit hydrograph, kinematic wave parameters, baseflow, loss rate), structure dimensions, inventories of gauge types and locations, etc. Time series data consist of values of a variable

for sequential points in time such as discharge and stage hydrographs, precipitation hyetographs, air temperature records, etc. Paired function data are sets of interrelated variables for which each value of one variable is paired with a value of another, such as discharge elevation, exceedance frequency-stage, reservoir storage-elevation, etc.

c. There are a number of commercial data bases that are well suited for the storage of individual element data. Such data bases are relational and permit queries such as "list all gauges within specified latitude and longitude bounds," or "list all subbasins for which the soils are in soil group A." Whether or not it is desirable to utilize a data base for individual element data depends on the data type and the frequency of use intended for the data.

d. Hydrologic studies generally make extensive use of time series data. Data bases that are designed specifically for this data type gain efficiency by treating such data in blocks (i.e., groups or sets) rather than as individual data items. Storage and retrieval is performed a block at a time. Block size might be, for example, one month for hourly data. A system designed for use with time series data is the data storage system (DSS) developed by the Hydrologic Engineering Center. It is configured as in Figure 15-1, with a number of water resource application programs having the capability to communicate with DSS files. A comprehensive set of data loading and utility programs supports the system.

e. Paired function data are also widely used in hydrologic studies. An advantage of central storage of discharge-elevation rating "curves," or any paired data, is that changes made to the data need to be made in one place only, and all application programs that use the data will have access to the revised data. The DSS system is designed to accommodate paired function data.

15-3. Geographic Information Systems

A powerful data management tool for spatial (i.e., geographically oriented) data is the geographic information system (GIS). Such systems enable the storage and retrieval of information that is associated with spatial elements such as rectangles, triangles, or irregularly shaped polygons. Variables such as slope, orientation, elevation, soil type, land use, average annual rainfall, etc. can be stored for each element. The data may then be retrieved and tabulated, displayed graphically, or used directly by application programs. Several commercial GIS's are available.

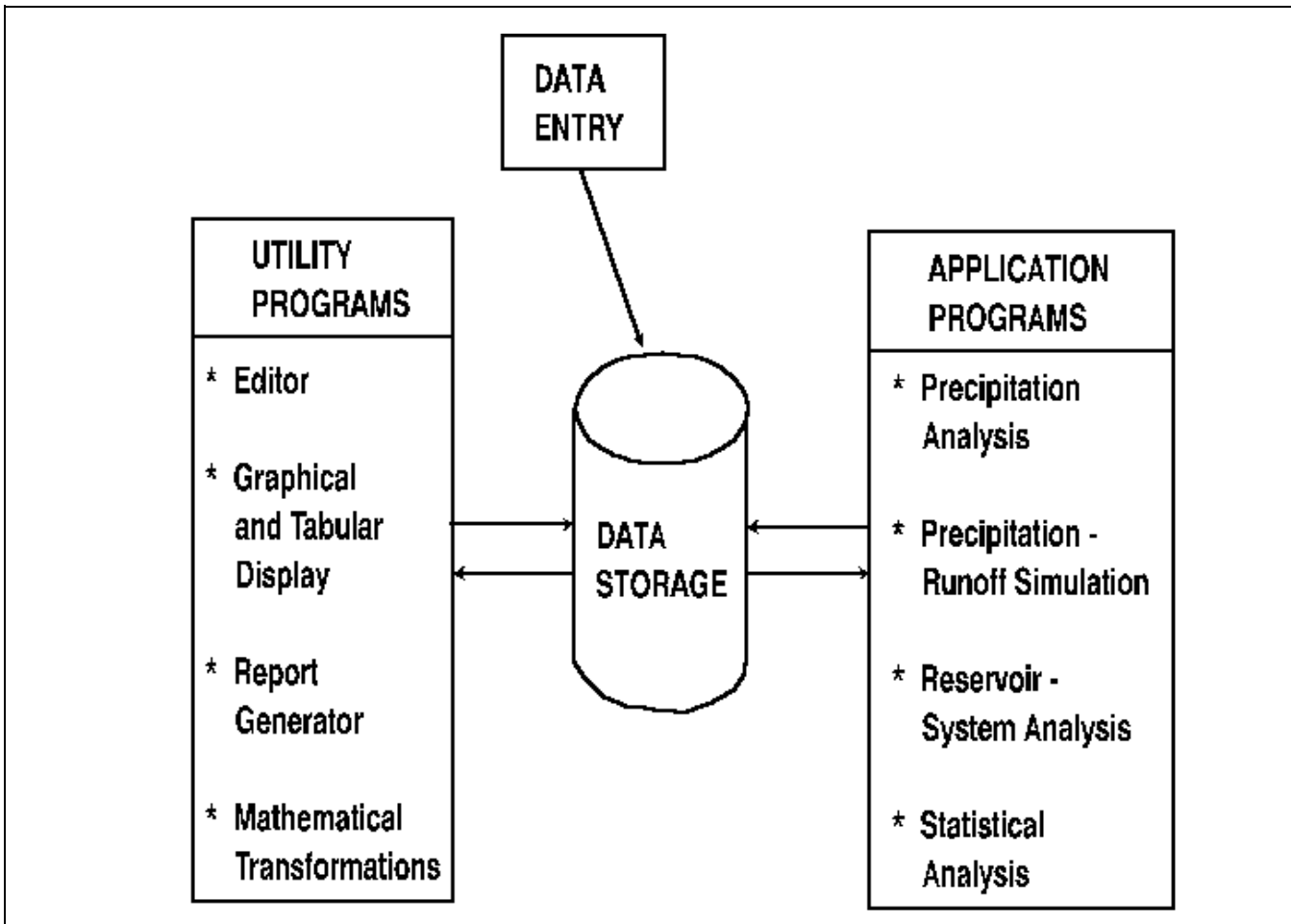

Figure 15-1. Data management

15-4. Data Acquisition and Use

a. The use of data typically involves the following: based on the purpose and scope of the study, determine the types of data that will be required; determine the sources and availability of the data; acquire and process the data; perform the analysis; and archive the data and study results. The first two steps are components of study formulation. As stated previously, the type, amount, and quality of data available for a study can have a significant impact on the choice of methodology and reliability of results.

b. Data for hydrologic investigations are generally obtained from several sources. For example, streamflow records are commonly available from the USGS, and daily and hourly rainfall values from the NWS. Also,

commercial firms obtain such data from collection agencies and make them available in useful form (e.g., on compact disk). Various formats are used to encode the data, and these must be interpreted as part of the process of loading data into a data base. There are a number of data loading programs associated with DSS, including programs to read data formats used on commercially available compact disks, NWS data formats and U.S. Geological Survey WATSTORE formats. In addition, software is available to read the Standard Hydro-meteorological Exchange Format (SHEF), which is accepted as a standard for data exchange by a number of agencies. The function of the loading programs is to read data in the appropriate format and enter that data into a DSS file. After the data has been loaded, utility programs can be used to graph or tabulate the data and perhaps edit or apply transforms to it (such as stage to discharge).

c. Application programs that have the capability to access data storage must be “told” what and how much data to retrieve. Such instructions are part of program input, as are instructions specifying the calculated information that is to be written to data storage. The capability to review application program results in tabular or graphical form with utility programs can be very powerful in facilitating the performance of a study. Final results can then be produced in report-quality form.

d. Upon completion of a study, data and study results should be prepared for long-term storage. Because formats used in specific data management systems may change over time, data should be stored in a system-independent format. For example, information from a DSS file can be transferred to a text (ASCII) file.

Chapter 16 Ungauged Basin Analysis

16-1. General

a. Problem definition. Earlier chapters of this manual described various flood-runoff analysis models. Some of the models are *causal*; they are based on the laws of thermodynamics and laws of conservation of mass, momentum, and energy. The St. Venant equations described in Chapter 9 are an example. Other models are *empirical*; they represent only the numerical relationship of observed output to observed input data. A linear-regression model that relates runoff volume to rainfall depth is an empirical model.

(1) To use either a causal or empirical flood-runoff analysis model, the analyst must identify model parameters for the catchment or channel in question. Paragraph 7-3*e* described a method for finding rainfall-runoff parameters for existing conditions in a gauged catchment. Through systematic search, parameter values are found to yield computed runoff hydrographs that best match observed hydrographs caused by observed rainfall. With these parameter values, runoff from other rainfall events can be estimated with the model. A similar search can be conducted for routing model parameters, given channel inflow and outflow hydrographs.

(2) Unfortunately, as Loague and Freeze (1985) point out, "...when it comes to models and data sets, there is a surprisingly small intersecting set." The rainfall and runoff data necessary to search for the existing-condition calibration parameters often are not available. Streamflow data may be missing, rainfall data may be sparse, or the available data may be unreliable. Furthermore, for USACE civil-works project evaluation, runoff estimates are required for the forecasted future and for with-project conditions. Rainfall and runoff data are never available for these conditions. In the absence of data required for parameter estimation for either existing or future conditions, the stream and contributing catchment are declared ungauged. This chapter presents alternatives for parameter estimation for such catchments.

b. Summary of solutions. To estimate runoff from an ungauged catchment, for existing or forecasted-future conditions, the analyst can use a model that includes only parameters that can be observed or inferred from measurements, or extrapolate parameters from parameters found for gauged catchments within the same region.

In practice, some combination of these solutions typically is employed, because most models include both physically based and calibration parameters.

c. Using models with physically based parameters. Model parameters may be classified as physically based parameters or as calibration parameters.

(1) Physically based parameters are those that can be observed or estimated directly from measurements of catchment or channel characteristics.

(2) Calibration parameters, on the other hand, are lumped, single-valued parameters that have no direct physical significance. They must be estimated from rainfall and runoff data. If data necessary for estimating the calibration parameters are not available, one solution is to use a flood-runoff analysis model that has only physically based parameters. For example, the parameters of the Muskingum-Cunge routing model described in paragraph 9-3*a*(6) are channel geometry, reach length, roughness coefficient, and slope. These parameters may be estimated with topographic maps, field surveys, photographs, and site visits. Therefore, that model may be used for analysis of an ungauged catchment.

d. Extrapolating calibration parameters. If the necessary rainfall or runoff data are not available to estimate calibration parameters using a search procedure such as that described in paragraph 7-3*e*, the parameters may be estimated indirectly through extrapolation of gauged-catchment results. This extrapolation is accomplished by developing equations that predict the calibration parameters for the gauged catchments as a function of measurable catchment characteristics. The assumption is that the resulting predictive equations apply for catchments other than those from which data are drawn for development of the equations. The steps in developing predictive relationships for calibration parameters for a rainfall-runoff model are as follows:

(1) Collect rainfall and discharge data for gauged catchments in the region. The catchments selected should have hydrological characteristics similar to the ungauged catchment of interest. For example, the gauged and ungauged catchments should have similar geomorphological and topographical characteristics. They should have similar land use, vegetative cover, and agricultural practices. The catchments should be of similar size. Rainfall distribution and magnitude and factors affecting rainfall losses should be similar. If possible, data should be collected for several flood events. These rainfall and

discharge data should represent, if possible, events consistent with the intended use of the model of the ungauged catchment. If the rainfall-runoff model will be used to predict runoff from large design storms, data from large historical storms should be used to estimate the calibration parameters.

(2) For each gauged catchment, use the data to estimate the calibration parameters for the selected rainfall-runoff model. The procedure is described in Chapter 7, and guidelines for application of the procedure are presented in Chapter 13 of this document.

(3) Select and measure or estimate physiographic characteristics of the gauged catchments to which the rainfall-runoff model parameters may be related. Table 16-1 lists candidate catchment characteristics. Some of these characteristics, such as the catchment area, are directly measured. Others, such as the Horton ratios, are computed from measured characteristics.

Table 16-1
Catchment Characteristics for Regression Models

Total catchment area
Area below lowest detention storage
Stream length
Stream length to catchment centroid
Average catchment slope
Average conveyance slope
Conveyance slope measured at 10% and 85% of stream length (from mouth)
Height differential
Elevation of catchment centroid
Average of elevation of points at 10% and 85% of stream length
Permeability of soil profile
Soil-moisture capacity average over soil profile
Hydrologic soil group
Population density
Street density
Impervious area
Directly-connected impervious area
Area drained by storm sewer system
Percent of channels that are concrete lined
Land use
Detention storage
Rainfall depth for specified frequency, duration
Rainfall intensity for specified frequency, duration
Horton's ratios (Horton 1945)
Drainage density (Smart 1972)
Length of overland flow (Smart 1972)

(4) Develop predictive equations that relate the calibration parameters found in step 2 with characteristics measured or estimated in step 3. In a simple case, the results of steps 2 and 3 may be plotted with the ordinate a rainfall-runoff model parameter and the abscissa a catchment characteristic selected in step 3. Each point of the plot will represent the value of the parameter and the selected characteristic for one gauged catchment. With such a plot, a relationship can be "fitted by eye" and sketched on the plot. Regression analysis is an alternative to the subjective graphical approach to defining a predictive relationship. Regression procedures numerically determine the optimal predictive equation. Details of regression analysis are presented in EM 1110-2-1415 and in most statistics texts, including those by Haan (1977) and McCuen and Snyder (1986).

(a) To apply a parameter-predictive equation for an ungauged catchment, the independent variables in the equation are measured or estimated for the ungauged catchment.

(b) Solution of the equation with these values yields the desired flood-runoff model parameter. This parameter is used with the same model to predict runoff from the ungauged catchment.

16-2. Loss-Model Parameter Estimates

a. Options. Two of the rainfall loss models described in Chapter 6 of this document are particularly useful for ungauged catchment analysis: the Green-Ampt model and the SCS model. The Green-Ampt model is a causal model with quasiphysically based parameters. The SCS loss model is an empirical model with parameters that have been related to catchment characteristics. Other loss models may be used if parameter-predictive equations are developed from gauged catchment data.

b. Physically based parameter estimates for Green-Ampt model. The Green-Ampt model is derived from Darcy's law for flow in porous media. The model predicts infiltration as a function of time with three parameters: volumetric moisture deficit, wetting-front suction, and hydraulic conductivity. In application, an initial loss may be included to represent interception and depression storage. Additional details of the Green-Ampt model are presented in Chapter 6.

(1) Brakensiek, and Onstad (1988), McCuen, Rawls, and Brakensiek (1981), Rawls and Brakensiek (1982a), Rawls, Brakensiek, and Saxton (1982b), Rawls and

Brakensiek (1983a), Rawls, Brakensiek, and Soni (1983b), and Rawls and Brakensiek (1985) propose relationships of the Green-Ampt model parameters to observable catchment characteristics, thus permitting application of the model to an ungauged catchment. The relationships define model parameters as a function of soil texture class.

(2) Texture class, in turn, is a function of soil particle size distribution. This distribution can be estimated from a sample of catchment soil. For example, a soil that is 80 percent sand, 5 percent clay, and 10 percent silt is classified as a loamy sand. For this texture class, Rawls and Brakensiek (1982a) and Rawls, Brakensiek, and Saxton (1982) suggest that the average saturated hydraulic conductivity is 6.11 cm/hr. The other parameters can be estimated similarly from the soil sample.

c. Predictive equations for SCS model parameters. The SCS loss model, described in detail in Chapter 6, is an empirical model with two parameters: initial abstraction and maximum watershed retention (maximum loss). Often both parameters are related to a single parameter, the curve number (CN). Using data from gauged catchments in the United States, the SCS developed a tabular relationship that predicts CN as a function of catchment soil type, land use/ground cover, and antecedent moisture. Table 16-2 is an excerpt from this table (U.S. Department of Agriculture (USDA) 1986).

(1) To apply the SCS loss model to an ungauged catchment, the analyst determines soil type from a catchment soil survey. For many locations in the United States, the SCS has conducted such surveys and published soil maps. The analyst determines existing-condition land use/ground cover from on-site inspection or through remote sensing. For future conditions, the land use/ground cover may be determined from development plans. The analyst selects an appropriate antecedent moisture condition for catchment conditions to be modeled (wet, dry, or average). With these three catchment characteristics estimated, the tabular relationship may be used to estimate CN. For example, for a residential catchment with 2-acre lots on hydrologic soil group C, the CN found in Table 6-6 for average antecedent moisture is 77. With this CN, the initial abstraction and maximum watershed retention can be estimated, and the loss from any storm can be predicted.

(2) Publications from the SCS provide additional details for estimating the CN for more complex cases.

16-3. Runoff-Model Parameter Estimates

a. Options. Chapter 7 presents a variety of models for estimating runoff due to excess rainfall. For an ungauged catchment, the analyst may use the kinematic-wave model, a UH model with physically-based parameters, or a UH model with predictive equations for the calibration parameters.

b. Physically based parameter estimates for kinematic wave model. The kinematic-wave model described in Chapter 7 is particularly well suited to analysis of an ungauged urban catchment.

(1) This causal model, which is described in further detail in HEC documents (USACE 1979, 1982, 1990a), represents the catchment rainfall-runoff process by solving theoretical equations for flow over planes. Catchment runoff is estimated by accumulating the flow from many such planes.

(2) Application of the model requires identification of the following parameters: catchment area, flow length, slope, and overland-flow roughness factor. The area, length, and slope are physically based and are estimated for existing catchment conditions from maps, photographs, or inspection. For forecasted-future condition, these parameters are forecasted from development plans. The overland-flow roughness factor is a quasiphysically based parameter that describes resistance to flow as a function of surface characteristics. Published relationships, based on hydraulic experimentation, are used to select this coefficient for existing or forecasted conditions. Thus all parameters of the kinematic wave model can be estimated without gauged data.

c. Physically based parameter estimates for Clark's IUH and SCS UH. Parameters of Clark's and the SCS empirical UH models have a strong link to the physical processes and thus can be estimated from observation or measurement of catchment characteristics. Clark's IUH accounts for translation and attenuation of overland and channel flow. Translation is described with the time-discharge histogram. To develop this histogram, the time of concentration is estimated and contributing areas are measured. Likewise, the SCS UH hydrograph peak and time to peak are estimated as a function of the time of concentration. The time of concentration, t_c , can be estimated for an ungauged catchment with principles of hydraulics. The SCS suggests that t_c is the sum of travel times for all

consecutive components of the drainage conveyance system (USDA 1986).

That is,

$$t_c = t_1 + t_2 + \dots + t_m \quad (16-1)$$

where

t_i = travel time for component i

m = number of components

Each component is categorized by the type of flow. In the headwaters of streams, the flow is sheet flow across a plane. Sheet-flow travel time is estimated via solution of the kinematic-wave equations. The SCS suggests a simplified solution. When flow from several planes combines, the result is shallow concentrated flow. The travel time for shallow concentrated flow is estimated with an open-channel flow model, such as Manning's equation. Shallow concentrated flow ultimately enters a channel. The travel time for channel flow is estimated also with Manning's equation or an equivalent model.

d. Predictive equations for UH calibration parameters. The procedure described in paragraph 16-1d can be used to develop predictive equations for UH model parameters for ungauged catchments. For example, Snyder (1938) related unit hydrograph lag, t_p , to a catchment shape factor using the following equation:

$$t_p = C_t (L L_{ca})^{0.3} \quad (16-2)$$

where

t_p = basin lag, in hours

C_t = predictive-equation parameter

L = length of main stream, in miles

L_{ca} = length from outlet to point on stream nearest centroid of catchment, in miles

The value of C_t is found via linear regression analysis with data from gauged catchments. A wide variety of predictive equations for UH model calibration parameters have been developed by analysts. Table 16-2 shows example equations for Snyder's and Clark's UH parameters. In general, these equations should not be used in regions other than those for which they were developed.

If they are, the analyst must be especially cautious. He or she should review derivation of the equations. Conditions under which the equations were derived should be examined and compared with conditions of the catchments of interest.

Table 16-2
Example UH Parameter Prediction Equations

Equation	Reference
$C_t = 7.81 / I^{0.78}$	Wright-McLaughlin Engineers (1969)
$C_p = 0.89 C_t^{0.46}$	Wright-McLaughlin Engineers (1969)
$R = c T_c$	Russell, Kenning, and Sunnell (1979)
$T_c / R = 1.46 - 0.0867 L^2/A$	Sabol (1988)
$T_c = 8.29 (1.00 + I)^{-1.28} (A/S)^{0.28}$	USACE (1982)

Note: In the above equations,

C_t = calibration coefficient for Snyder's UH (see paragraph 7-3c)

C_p = calibration coefficient for Snyder's UH (see paragraph 7-3c)

T_c = time of concentration, in hours

R = Clark's IUH storage coefficient, in hours

I = impervious area, in percent

L = length of channel/ditch from headwater to outlet, in miles

S = average watershed slope, in feet per foot

c = calibration parameter (for forested catchments = 8 - 12, for rural catchments = 1.5 - 2.8, and for developed catchments = 1.1 - 2.1)

A = catchment area, in square miles

16-4. Routing-Model Parameter Estimates

a. Candidate models. The routing models described in Chapter 9 account for flood flow in channels. Of the models presented, the Muskingum-Cunge, modified puls, and kinematic-wave are most easily applied in ungauged catchments. Parameters of each of these models are quasiphysically based and can be estimated from channel characteristics.

b. Physically based parameter estimates for modified puls routing model. The modified puls (level-pool) routing model is described in detail in Chapter 9-3. The

parameters of this model, as it is applied to a river channel, include the channel storage versus outflow relationship and the number of steps (subreaches). The former is considered a physically based parameter, while the latter is a calibration parameter.

(1) For an ungauged catchment, the channel storage versus outflow relationship can be developed with normal depth calculations or steady-flow profile computations. In either case, channel cross sections are required. These may be measured in the field, or they may be determined from previous mapping or aerial photography. Both procedures also require estimates of the channel roughness. Again, this may be estimated from field inspection or from photographs. With principles of hydraulics, water-surface elevations are estimated for selected discharges. From the elevations, the storage volume is estimated with solid geometry. Repetition yields the necessary storage versus outflow relationship. These computations can be accomplished conveniently with a water-surface profile computer program, such as HEC-2 (USACE 1990b).

(2) The second parameter, the number of steps, is a calibration parameter. Paragraph 9-3a suggests estimating the number of steps as channel reach length/velocity of the flood wave/time interval (Eq. 9-13). Strelkoff (1980) suggests that if the flow is controlled heavily from downstream, one step should be used. For locally controlled flow typical of steeper channels, he suggests the more steps, the better. He reports that in numerical experiments with such a channel, the best peak reproduction was observed with:

$$NSTPS = 2 L \frac{S_o}{Y_o} \quad (16-3)$$

where

$NSTPS$ = number of steps

L = entire reach length, in miles

S_o = bottom slope, in feet per mile

Y_o = baseflow normal depth, in feet

So, for example, for a 12.4-mile reach with slope 2.4 ft/mile and $Y_o = 4$ ft, the number of steps would be estimated as 15.

c. Physically based parameter estimates for kinematic wave model. The physical basis of the kinematic-wave model parameters makes that model useful for some

ungauged channels. In particular, if the channels are steep and well-defined with insignificant backwater effects, the kinematic-wave model works well. These limitations are met most frequently in channels in urban catchments.

(1) The parameters of the kinematic-wave channel routing model include the channel geometry and channel roughness factor. The necessary channel geometry parameters include channel cross section and slope data. Since these are physically based, they may be estimated for existing conditions from topographic maps or field survey.

(2) For modified channel conditions, the geometry data are specified by the proposed design. The roughness generally is expressed in terms of Manning's n . This is a quasiphysically based parameter that describes resistance to flow as a function of surface characteristics. Published relationships predict this coefficient for existing or modified conditions.

d. Physically based parameter estimates for Muskingum-Cunge model. If the channel of interest is not steep and well-defined as required for application of the kinematic-wave channel routing model, a diffusion model may be used instead. In the case of an ungauged channel, the Muskingum-Cunge model is a convenient choice, since the parameters are physically based.

(1) Parameters of the Muskingum-Cunge channel routing model include the channel geometry and channel roughness factor. The necessary channel geometry parameters include channel cross section and slope data, which may be estimated for existing conditions from topographic maps or field survey.

(2) For modified channel conditions, the geometry data are specified by the proposed design. The roughness is expressed in terms of Manning's n .

16-5. Statistical-Model Parameter Estimates

In some hydrologic-engineering studies, the goal is limited to definition of discharge-frequency relationships. EM 1110-2-1415 describes procedures for USACE flood-frequency studies. Chapter 12 of this document summarizes those procedures and describes the statistical models used. All the models described are empirical. Observed data are necessary for calibration. Consequently, these statistical models cannot be applied directly to an ungauged catchment. Options available to the analyst requiring frequency estimates for an ungauged

stream include development of frequency-distribution parameter predictive equations, and development of distribution quantile predictive equations.

a. Parameter predictive equations. The log Pearson type III distribution (model) is used for USACE annual maximum discharge-frequency studies. As described in Chapter 12, this model has three parameters. These are estimated from the mean, standard deviation, and skew coefficient of the logarithms of observed peak discharges.

(1) In the absence of flow data, regional-frequency analysis procedures described in paragraph 12-5c may be applied to develop distribution parameter predictive equations. As with the equations for rainfall-runoff model parameters, these equations relate model parameters to catchment characteristics. For example, for the Shellpot Creek Catchment, Delaware, the following predictive equation was developed (USACE 1982):

$$S = 0.311 - 0.05 \log A \quad (16-4)$$

where

S = standard deviation of logarithms

A = catchment drainage area, in square miles

With similar equations, other parameters can be estimated.

(2) To apply a distribution parameter-predictive equation for an ungauged catchment, the independent variables in the equation are measured or estimated for the ungauged catchment. Solution of the equation with these values yields the desired statistical distribution parameter. The frequency curve is then computed as described in EM 1110-2-1415 and Chapter 12.

b. Quantile predictive equations. The frequency-distribution quantiles for an ungauged catchment also may be defined with predictive equations. Such a predictive equation is developed by defining the frequency distributions for streams with gauged data, identifying from the distributions specified quantiles, and using regression analysis procedures to derive a predictive equation. For example, for the Red Lion Creek Catchment, Delaware, the following quantile predictive equation was developed (USACE 1982):

$$Q_{100} = 1040 A^{0.91} \quad (16-5)$$

where Q_{100} = 100-year (0.01 probability) discharge.

16-6. Reliability of Estimates

The reliability of a runoff estimate made for an ungauged catchment is a function of the reliability of the flood-runoff model, the form of the predictive equation and its coefficients, and the talents and experience of the analyst.

a. Model reliability. Linsley (1986) relates the results of a 1981 pilot test by the Hydrology Committee of the USWRC that found that all runoff models tested were subject to very large errors and exhibited a pronounced bias to overestimate. He shows that errors of plus or minus 10 percent in estimating discharge for a desired 100-year (0.01 probability) event may, in fact, yield an event as small as a 30-year event or as large as a 190-year event for design. Lettenmaier (1984) categorizes the sources of error as model error, input error, and parameter error. Model error is the inability of a model to predict runoff accurately, even given the correct parameters and input. Input error is the result of error in specifying rainfall for predicting runoff or in specifying rainfall and runoff for estimating the model parameters. This input error may be due to measurement errors or timing errors. Parameter error is the result of inability to properly measure physically based parameters or to properly estimate calibration parameters. The net impact of these errors is impossible to quantify. They are identified here only to indicate sources of uncertainty in discharge prediction.

b. Predictive equation reliability. Predictive equations are subject to the same errors as runoff models. The form and parameters of the equations are not known and must be found by trial and error. The sample size upon which the decision must be based is very small by statistical standards because data are available for relatively few gauged catchments. Overton and Meadows (1976) go so far as to suggest that the reliability of a regionalized model can always be improved by incorporating a larger data base into the analysis. Predictive equations are also subject to input error. Many of the catchment characteristics used in predictive equations have considerable uncertainty in their measured values. For example, the accuracy of stream length and slope estimates are a function of map scale (Pilgrim 1986). Furthermore, many of the characteristics are strongly correlated, thus increasing the risk of invalid and illogical relationships.

c. Role of hydrologic engineer. Loague and Freeze (1985) suggest that hydrologic modeling is more an art than a science. Consequently, the usefulness of the results depends in large measure on the talents and experience of the hydrologic engineer and her or his understanding of the mathematical nuances of a particular model and the hydrologic nuances of a particular catchment. This

position is especially true in estimation of runoff from an ungauged catchment. The hydrologic engineer must exercise wisdom in selecting data for gauged catchments, in estimating flood-runoff model parameters for these catchments, in establishing predictive relationships, and finally, in applying the relationships.

Chapter 17 Development of Frequency-Based Estimates

17-1. Introduction

Frequency-based estimates of flood discharge are a fundamental requirement for flood-risk investigations and flood-damage analysis. The development of such estimates is a challenging task that requires sound interpretation of regional historical flood-related data and appropriate application of various analytical techniques. This chapter deals with issues such as choice of methodology, use of hypothetical storms in frequency determinations, transfer of frequency-based information from gauged to ungauged sites, development of future-condition frequency estimates, and adjustment of peak discharges to represent stationary conditions.

17-2. Choice of Methodology

a. Choice of methodology for frequency curve development will depend on the purpose of a study and characteristics of available data. Possible methods include the following:

- (1) Statistical analysis of observed streamflow data.
- (2) Regional frequency analysis.
- (3) Event-type precipitation-runoff analysis with hypothetical storms.
- (4) Period-of-record precipitation-runoff analysis.

b. Key questions related to study purpose are as follows:

- (1) Will effects of future land-use changes or project alternatives be evaluated?
- (2) Is period-of-record type information required because of the nature of the study?
- (3) What are accuracy and reliability requirements?

c. The answer to the first question is a primary determinant for choice of methodology. If it is necessary to model future land-use changes and/or the effects of projects, application of a precipitation-runoff simulation model is generally essential. The answer to the second

question will determine whether the simulation model should have capability for period-of-record analysis. For example, analysis of pond stage on the interior (landward) side of a levee often requires such analysis to reflect the coincident effects of exterior (main river) stage and interior runoff. If modeling of future land-use changes and/or projects is not required, choice of methodology will depend on availability of data and accuracy and reliability requirements. Key questions related to available data are as follows:

- (1) Are long-term historical discharge records available for the location(s) of interest?
- (2) Are long-term historical discharge records available for nearby sites?
- (3) Are short-term discharge records available for the location(s) of interest?
- (4) Are (applicable) regional-frequency relationships available for the location(s) of interest?

d. “Long-term” as used here refers to a length of record sufficient to enable development of statistically based frequency estimates of reasonable reliability. Long-term data is extremely valuable and generally provides the most reliable basis for frequency determinations. If land-use conditions have changed during the period of collecting the long-term data, or if there are reservoirs (with significant capacity to store flood runoff) upstream of the location(s) of interest, the period-of-record peak discharges must generally be adjusted to represent a stationary, storage-free condition. The making of such adjustments can require substantial analysis and application of simulation.

e. If long-record data are not available for the location(s) of interest, it may be possible to transfer (and adjust) discharge data or frequency-based information from nearby, similar locations. Such transfer can be difficult, and reliability of results is affected by the transfer process. However, use of such data can be of substantial value and can result in frequency estimates that are significantly more reliable than could be produced without such data.

f. “Short-term” as used here implies that discharge records are insufficient to enable development of statistically based frequency estimates of reasonable reliability. Short-term data can, however, be adequate to enable the calibration of a precipitation-runoff simulation model.

Hence, the availability of such data is very significant when a simulation approach is required.

g. When land-use changes and/or project conditions are not a factor, it may be possible to employ regional-frequency relations. Previously determined relations should be applied carefully; their applicability should be verified, and independent variables should be evaluated properly.

h. In many cases, frequency estimates should be developed by several independent techniques. Different segments of the adopted frequency curve may be derived from different sources depending on the basis for, and reliability of, the individual estimates. All the means at one's disposal should be used to verify resulting estimates. For example, it may be reasonable to expect that the standard project flood would have a magnitude within a certain range of exceedance frequency. The range can be used as a rough check for the upper end of a derived frequency curve. Historical accounts of flooding should be used, if possible, to verify estimates. Peak discharge envelope curves may also be useful.

17-3. Hypothetical Storm Frequency

a. The magnitude and spatial and temporal characteristics of every natural storm is unique. Hence, it is only possible to determine probabilities for average storm depths over specific areas and for specific durations. Although generalized rainfall criteria such as that provided in NOAA publications associate recurrence intervals with rainfall depths, the recurrence interval (or exceedance frequency) of a hypothetical storm developed from such depths is indeterminate. To label a storm as a "100-year" or "25-year" storm can therefore, be misleading.

b. What is generally of primary interest is the exceedance frequency of streamflow peaks and volumes. Attempts are, therefore, made to devise hypothetical storms that can be associated with the generation of streamflow peaks and/or volumes of specified exceedance frequency. However, the runoff generated by a particular storm will be a function of the state of the watershed when the storm occurs. A major storm occurring on a very dry watershed can result in moderate runoff, and a moderate storm on a saturated watershed can result in substantial runoff. Streamflow peaks or volumes of a specified frequency can be caused by an infinite number of combinations of storms and watershed states.

c. Paragraph 13-4 addresses the development of a *balanced* hypothetical storm. With such a storm, the average depth of rainfall for a duration equal to the time of concentration for a watershed will have a 'known' exceedance frequency, as will the average depth for any other duration. However, the triangular temporal distribution of rainfall will generally not be representative of natural storms. For watersheds with substantial natural storage, the streamflow at the outlet may be relatively insensitive to the temporal distribution, whereas for a watershed with a short response time, the resulting streamflow may be quite sensitive. Methods have been developed (Huff 1967, Pilgrim and Cordery 1975) that base the time distribution of a hypothetical storm on distributions observed in historical storms.

d. Associated with application of a hypothetical storm is selection of a storm duration. When a balanced hypothetical storm is used, the duration is generally chosen to equal or exceed the time of concentration for a watershed. The infiltration rate that pertains during the period of peak storm intensities will depend on how dry the watershed is initially and on how much infiltration occurs during the early part of the storm. If a storm duration substantially longer than the time of concentration is used, the infiltration rate during the period of peak storm intensities may be unreasonably low because of the large volume of infiltration that occurs initially. Sensitivity analysis can be useful to determine the effects of storm duration.

e. Another issue is the spatial distribution of hypothetical-storm rainfall. A common assumption is that the distribution is uniform. Such an assumption is consistent with use of a nondistributed model for an elemental basin (i.e., one which is not subdivided). However, for a large, subdivided basin, such an assumption may not be reasonable, especially if orographic or other effects tend to result in substantial deviations from a uniform distribution. Analysis of storm patterns for historical events can provide insight as to the variability of the spatial distribution and whether or not there is a tendency for relatively greater concentrations of rainfall in some subbasins and less in others. It may be appropriate to distribute hypothetical-storm rainfall in accordance with a representative pattern based on such analysis.

f. Also, with large basins, it may be unreasonable to assume that the temporal distribution of rainfall is the same for all subbasins. Such an assumption implies that storm movement and other phenomena affecting the

timing of rainfall are not important. Analysis of historical precipitation data can provide a basis for evaluating temporal characteristics of large storms over the basin.

17-4. Transfer of Frequency Information with Hypothetical Events

a. A situation commonly occurs where there are one or more gauged locations with long-term streamflow records in the vicinity of ungauged locations for which discharge-frequency estimates are required. When this is the case, it may be possible to develop discharge-frequency estimates for an ungauged location by transferring frequency-based information from a gauged location using simulation of runoff from hypothetical storms. A prerequisite for this approach is that storm-occurrence characteristics for the gauged and ungauged basin be essentially the same; that is, there should be about equal likelihood that a storm of a given magnitude could occur over either basin. The procedure is as follows:

(1) Let Basin A be a gauged basin for which there is a sufficient length of record to enable development of a discharge frequency relation by statistical procedures. Develop and calibrate an event-type precipitation-runoff model for Basin A.

(2) Let Basin B be the basin for which a discharge frequency relation is required. There may be no streamflow data for the basin, or there may be a limited amount of streamflow data which may be adequate to enable calibration of a precipitation-runoff model. In any case, develop (and if possible, calibrate) a precipitation-runoff model for the basin.

(3) Apply a set of hypothetical storms to Basin A. These may correspond to the various recurrence intervals associated with NOAA criteria, or they may simply be proportions of a single hypothetical storm. If storms of specific recurrence intervals are used, adjust loss rates, if possible, so that an x percent-chance storm produces an x percent-chance peak discharge as defined by the statistically derived frequency curve. If this is not possible, or if loss rates so determined are not reasonable, use reasonable loss rates and determine the percent-chance exceedances of the resulting peak discharges for Basin A from the statistically derived frequency curve.

(4) Apply the storm and antecedent moisture condition combinations used for Basin A in the Basin B model. Associate resulting peak discharges for Basin B with the exceedance frequencies of the events as established for Basin A.

b. An advantage of using storms with defined exceedance frequencies rather than proportioned storms and adjusting loss rates as required to produce peak discharges of the same frequencies is that the loss rates so derived can be checked for consistency. Typically, loss rates decrease with decreasing storm frequency. However, it is often not possible to reconcile storms, loss rates, and the 'known' frequency curve in a reasonable fashion, in which case the storm and antecedent moisture condition combinations are treated simply as index events without regard to assigning predetermined exceedance frequencies to them.

17-5. Development of Future-Condition Frequency Estimates

a. The development of frequency estimates for future conditions based on estimates for existing conditions can be accomplished using an approach similar to that for transferring frequency information from a gauged to an ungauged location. A procedure is as follows:

(1) Develop an existing-condition frequency curve by whatever means is appropriate considering study requirements and data availability.

(2) Develop and calibrate (if possible) an event-type rainfall-runoff simulation model to represent existing conditions.

(3) Apply a set of hypothetical storms with the existing-condition model and associate exceedance frequencies of the storm and antecedent moisture condition combinations with the exceedance frequencies of the resulting peak discharges from the existing-condition frequency curve.

(4) Adjust the existing-condition simulation model to represent future conditions. This may involve, for example, changes to values for percent imperviousness, unit hydrograph or kinematic wave parameters, and routing parameters. Chapter 18 is concerned with techniques for modeling watershed changes.

(5) Apply the same storm and antecedent moisture combinations used for existing conditions to simulate corresponding future-condition peak discharges. Assign exceedance frequencies determined for the events for existing conditions to the future-condition peak discharges.

b. If the future condition is to include new storage elements such as detention reservoirs, such elements must

be added to the future-condition model. The modeling of storage elements involves additional considerations, however, because as antecedent storage conditions can be very significant. A period-of-record analysis may be the most viable approach in this case. Chapter 18 provides further discussion on this topic.

17-6. Adjustment of Peak Discharges to Represent Stationary Conditions

a. A common problem in statistical analysis of annual peak discharges is that watershed changes have occurred during the period of record so that the annual values reflect nonstationary conditions. If the changes are primarily due to the construction of storage reservoirs, it is possible to adjust hydrographs at a downstream gauge to natural conditions by routing reservoir *holdouts* (increments of stored water) to the gauge and adding the routed discharge to the observed discharge. A statistical analysis of the adjusted peaks could then be performed to produce a natural-condition frequency curve.

b. If watershed changes are due to effects of urbanization such as land use and channel modifications, it is generally much more difficult to make adjustments to stationary conditions. An approach for adjusting peak discharges to existing conditions is as follows:

(1) Develop and calibrate a rainfall-runoff model for existing basin conditions and for conditions at several other points in time during the period of record. In the example illustrated in Figure 17-1, rainfall-runoff models were developed to represent existing basin conditions (for the year 1975, in this example), and conditions in the years 1960, 1950, and 1940.

(2) Develop an *x* percent-chance hypothetical storm for the basin using generalized rainfall criteria. The

recurrence interval is arbitrary as it is not assumed in this approach that runoff frequency is equal to rainfall frequency. The purpose of adopting a specific magnitude is to establish a base storm to which ratios can be applied for subsequent steps in the analysis.

(3) Apply several ratios to the hypothetical storm developed in step (2) so that the resulting calculated peak discharges at the gauge cover the range desired for frequency analysis. Input the storms to the rainfall-runoff models for each of the basin conditions and determine peak discharges at the gauged location.

(4) Plot curves representing peak discharge versus storm ratio for each basin condition, as illustrated in Figure 17-1.

(5) Use the curves developed in the previous step to adjust the observed annual peak discharges. For example, an annual peak discharge for 1963 would be used to enter the family of storm-ratio curves to interpolate a storm ratio consistent with that peak. This storm ratio can then be used to intersect the base-condition (for example, existing condition) curve to determine the adjusted peak discharge. The adjustment method is applied for each of the annual peaks of record.

(6) A statistical analysis of the adjusted peak discharges can then be performed.

c. The above approach can also be extended to apply to a future condition. For example, a basin model could be developed to represent year 2020 conditions, and a corresponding storm-ratio curve developed. The observed annual peak discharges could then be adjusted as in step (5) above to year 2020 conditions.

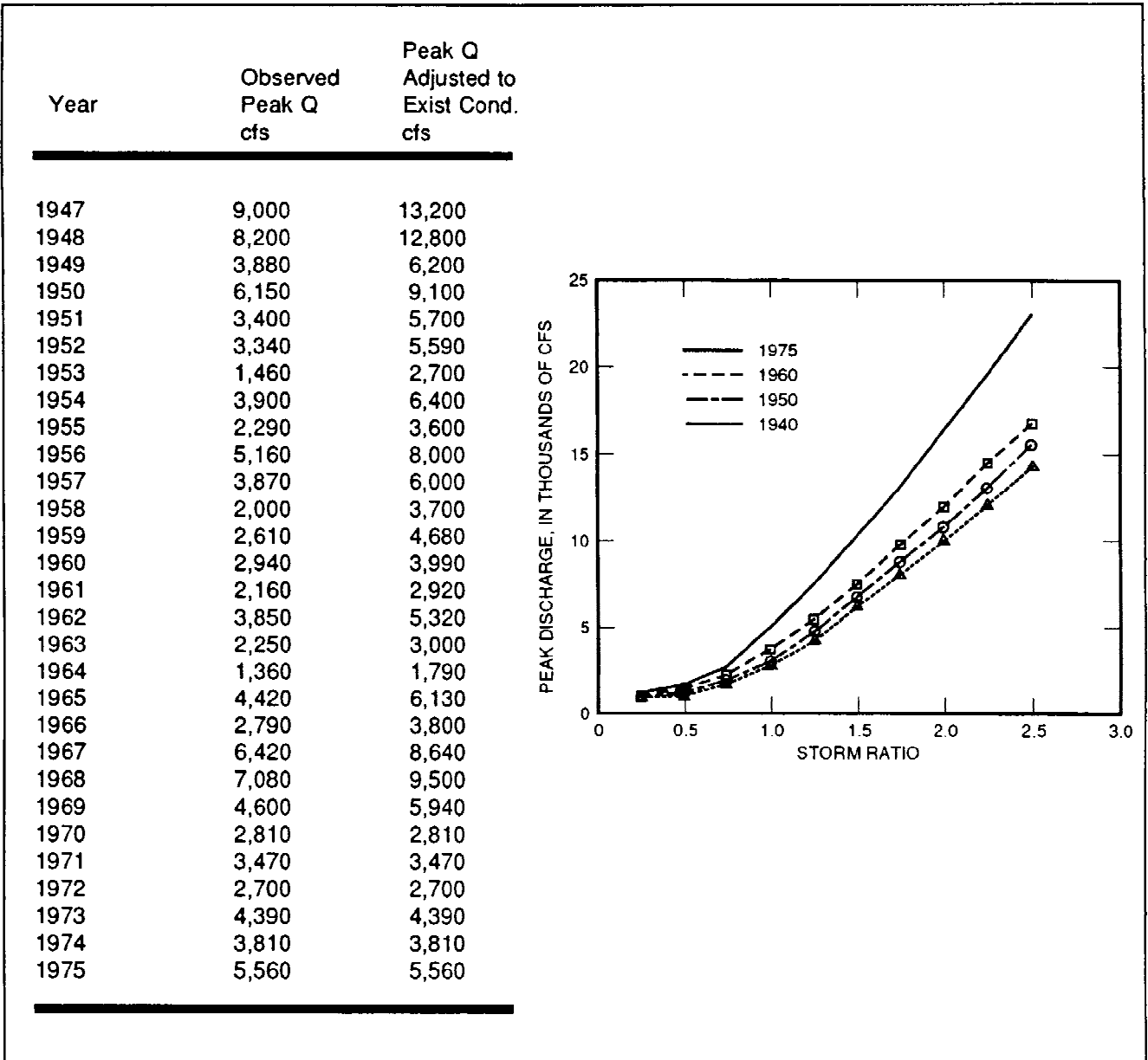

Figure 17-1. Conversion of nonstationary to stationary peak discharges

Chapter 18 Evaluating Change

18-1. General

a. Sources of change and methods of evaluation.

(1) Flood-runoff from a catchment may change as a consequence of human action. Some human actions are taken with the expressed goal of altering the runoff. Construction of a reservoir in the catchment is an example. Other human actions alter the catchment and conveyance system only as a side effect. Nevertheless, the actions alter the runoff. An example of this is conversion of an agricultural field to a residential neighborhood.

(2) Flood-runoff from a catchment may change also as a consequence of natural phenomena, if the phenomena change the catchment or conveyance system. For example, a lightning-caused range fire may alter the vegetative cover, and consequently, the rate of runoff from a catchment.

b. Illustration. This chapter illustrates the use of the infiltration, runoff, routing, and statistical models described in previous chapters of this document to evaluate the impacts of human action and natural phenomena. Here, the evaluation is limited to analysis of changes to runoff hydrographs, discharge-frequency curves, and rating curves.

18-2. Evaluating Catchment and Conveyance-System Change

a. Effects of change on floods. Catchments and conveyance systems may be modified by human action, such as urbanization, or by natural phenomena, such as lightning-caused range fire. These changes alter runoff hydrographs from single events. Consequently, these changes also alter the discharge-frequency relationship.

According to Leopold (1968),

... the two principal factors governing flow regimen are the percentage of (catchment) area made impervious and the rate at which water is transmitted across the land to stream channels. The former is governed by the type of land use; the latter is governed by the density, size, and characteristics of tributary channels...

Development or urbanization in a catchment typically is accompanied by an increase in impervious area. As the impervious area increases, the infiltration decreases. As infiltration decreases, the volume of runoff from a storm increases. As the volume increases, the magnitude of the flood peak increases. An increase in impervious area also speeds the flow of water across the land, and this increases the flood peak. Likewise, improvements to or expansion of the catchment conveyance system speeds the flow and increases the peak.

b. Evaluation with a rainfall-runoff model. The impact of watershed changes can be estimated conveniently with a rainfall-runoff model that includes only parameters that are measurable or parameters that are directly related to catchment characteristics. Given a description of the proposed changes to the catchment or the conveyance system, these parameters can be estimated. An example of a (pseudo) physically based rainfall-runoff model is the kinematic-wave model. Application of this model requires identification of catchment area, flow length, slope, and overland-flow roughness factor. To evaluate the impact of catchment or conveyance-system changes with this model, these parameters are estimated from maps, photographs, inspection, or, in the case of future conditions, from development plans. With the modified parameters, runoff can be estimated for any storm.

(1) The impact on the discharge-frequency curve can be evaluated with a rainfall-runoff model via period-of-record analysis. The period-of-record analysis computes runoff from the entire time series of historical rainfall or from a lengthy series of equally likely rainfall (Chapter 12 of EM 1110-2-1415). The resulting series of runoff is analyzed with the statistical-analysis procedures described in Chapter 12 to define the modified-condition discharge-frequency curve. This analysis is straightforward but data-intensive and time-consuming.

(2) Simulation of selected historical events is an alternative to a complete period-of-record analysis. This procedure uses historical rainfall and runoff data. The existing, present-condition discharge-frequency curve is determined by statistical analysis of the discharge time series. To estimate the modified discharge-frequency curve, a rainfall event is selected from the historical record. The probability of the historical runoff peak corresponding to the event is determined from the existing conditions discharge-frequency curve. Runoff due to the rainfall after catchment and conveyance-system

changes is estimated by simulation, with model parameters selected to represent the modified condition. This peak discharge is assigned the same probability as the existing-condition peak. This is repeated for a range of rainfall events to adequately define the modified discharge-frequency curve.

(3) If historical rainfall and runoff data are not available, the modified-condition discharge-frequency curve can be estimated with hypothetical rainfall. To estimate the discharge-frequency curve, a design storm of specified probability is developed. Runoff due to the rainfall event after catchment and conveyance-system changes is estimated by simulation, with model parameters selected to represent the modified condition. The computed modified-condition peak is assigned the same probability as the design storm. This is repeated for a range of hypothetical rainfall events to adequately define the modified discharge-frequency curve. This procedure is described in Chapter 17.

c. Evaluation with regional rainfall-runoff model parameters. The impact of watershed changes can be estimated with an rainfall-runoff model with calibration parameters, using parameter-predictive equations. With gauged data, these parameters are determined by trial and error, comparing computed hydrographs with observed hydrographs. As described in Chapter 16, predictive equations may be developed to permit estimation of the parameters for ungauged catchments. These predictive equations relate the calibration parameters to catchment characteristics. A simple example is the following equation, proposed by Wright-McLaughlin Engineers (1969) to predict a parameter for Snyder's synthetic unit hydrograph, in the Denver metropolitan area:

$$C_i = \frac{7.81}{I^{0.76}} \quad (18-1)$$

where

C_i = Snyder's unit hydrograph parameter (paragraph 7-3c)

I = catchment impervious area, in percentage.

As a natural catchment is developed, the impervious area typically increases. With (Equation 18-1) and Snyder's model, the resulting change in the unit hydrograph can be predicted. Application of the unit hydrograph permits estimation of the runoff from any storm. Similar

equations can be developed and applied to estimate parameters for other rainfall-runoff models.

(1) The SCS loss and unit hydrograph models are especially convenient empirical models for estimating modifications to runoff due to catchment and conveyance-system changes (USDA 1986). The SCS loss model parameter is predicted as a function of land use, soil type, and antecedent-moisture condition. The unit hydrograph model parameter may be predicted as a function of land use, soil type, antecedent-moisture condition, slope, and flow length. For existing, current conditions, these can be observed or measured. For modified conditions, these can be forecasted.

(2) A GIS is helpful for developing the physical-feature data base required for evaluation of changes. A GIS is a computerized data base management system with spatial references for all data. The simplest GIS is a rectangular grid superimposed on a map of the catchment. Pertinent characteristics are determined and stored in a data base for each cell of the grid. For example, for the SCS models, land-use type, soil type, moisture condition, slope, and length can be stored. Once stored, the characteristics can be retrieved and mapped. They also can be manipulated for use with parameter predictive equations, such as those that predict loss rate parameters for the SCS model. A GIS is convenient for evaluating runoff changes due to future catchment or conveyance systems (DeBarry and Carrington 1990). With proposed land-use types stored in the GIS, the modified-condition model parameters can be determined easily, and the runoff can be computed. Of course, the reliability is a function of the quality of the data stored and the reliability of the parameter-predictive equations.

(3) Given rainfall-runoff model parameters determined with predictive equations, the impact of watershed and conveyance-system changes on the discharge-frequency curve can be evaluated using the same procedures described for the model with physically based parameters. A period-of-record analysis can be performed to develop a modified condition time series. Alternatively, selected historical or hypothetical events can be simulated.

d. Evaluation with regional frequency-model parameters. The lumped impact of watershed and conveyance-system changes on the discharge-frequency curve can be evaluated with frequency-based model parameter predictive equations. Paragraph 16-6 of this document

describes how frequency-based model parameters or discharge-frequency relationships may be related to catchment characteristics. If these characteristics can reflect catchment and conveyance-system changes, the equations can directly predict the modified-condition discharge-frequency curve.

(1) Quantiles for the modified discharge-frequency curve can be estimated with a predictive equation. For example, Sauer et al. (1983) propose the following equation to estimate the 0.01-probability peak discharge for a developed urban catchment:

$$UQ100 = 2.50 A^{0.29} SL^{0.15} (RI2 + 3)^{1.76} (ST+8)^{-0.52} (13-BDF)SIP - 0.28IA^{0.06} RQ100^{0.63} \quad (18-2)$$

where

$UQ100$ = discharge, in cubic feet per second

A = catchment contributing area, in square miles

SL = channel slope, in feet per mile

$RI2$ = basin rainfall, in inches

ST = basin storage, in percentage

BDF = basin development factor (0 to 12)

IA = impervious area, in percentage

$RQ100$ = equivalent rural peak discharge, in cubic feet per second

$RQ100$ is estimated independently with statistical analysis of the historical time series. For forecasted or proposed changes, the slope, storage, development factor, and impervious area can be estimated. With (Equation 18-2), the modified 0.01-probability discharge is estimated. Similar equations can be developed for other quantiles or with other catchment characteristics.

(2) Equations can also be developed to predict the statistical model parameters as a function of catchment characteristics. For example, the standard deviation in (Equation 12-9) can be correlated with catchment characteristics. The resulting equation could permit estimation of current, future, existing, or proposed condition

parameters. With these parameters and the distribution equation, the discharge-frequency relationship is defined.

18-3. Procedure for Evaluating Damage-Reduction Plans

a. Damage-reduction measures. Flood damage can be reduced by decreasing flow rate, decreasing the depth of water, and decreasing directly the damage caused by flooding. Table 18-1 lists measures that reduce flood damage, classifying each by impact. A mitigation plan comprises one or more of these measures.

b. Plan evaluation criterion. The effectiveness of any plan is quantified in terms of inundation-damage reduction benefit. Guidelines for Federal water-resources planning define this as:

$$E(B_{IR}) = [E(D_{exist}) - E(D_{plan})] \quad (18-3)$$

where

B_{IR} = inundation-reduction benefit

D_{exist} = existing-condition flood-damage cost (without a plan)

D_{plan} = flood-damage cost with the plan in place

E = the expected value (USWRC 1983).

Chapter 7 of EM 1110-2-1415 describes alternative approaches to computing the expected value. The most widely used approach in USACE is the frequency technique. To compute expected damage with the frequency technique, the damage-frequency curve is derived by transforming the annual-maximum discharge-frequency curve with the elevation-discharge (rating) function and the elevation-damage function. This is illustrated by Figure 18-1. The expected damage is the area beneath (the integral of) this damage-frequency relationship. The Hydrologic Engineering Center's Expected Annual Flood Damage (EAD) computer program derives the damage-frequency curve following this procedure and integrates the result numerically (USACE 1984a).

(1) For computation of expected damage, the hydrologic engineer must define the discharge-frequency curve and rating functions for existing and proposed conditions, accounting for current and future catchment and conveyance-system conditions. Table 18-2 shows how the

Table 18-1
Damage-Reduction Measures, Classified by Impact

Decrease Flow Rate	Decrease Depth of Flooding	Decrease Damage Directly
Reservoir	Channel alteration	Floodplain management
Diversion	Levee/ floodwall	Floodproofing
Watershed management		Flood warning and preparedness planning

functions are modified by each of the damage-reduction measures listed in Table 18-1.

(2) Mathematical tools described in Part II of this document and in EM 1110-2-1416, EM 1110-2-1413, and EM 1110-2-1415 are used for the analysis.

c. Summary of evaluation procedures. The economic impact of catchment and conveyance system changes and of flood-damage mitigation measures is determined via solution of Equation 18-3. This may be accomplished as follows:

(1) Define the existing-condition discharge-frequency curve, rating, and elevation-damage functions. To define the discharge-frequency curve, rainfall-runoff and routing models or statistical models are used. To define the rating function, routing models or the hydraulics models described in EM 1110-2-1416 may be employed.

(2) Derive the damage-frequency curve using the procedure illustrated by Figure 18-1. Integrate to compute expected inundation damage for the existing condition.

(3) Identify the plan to be evaluated. Perform the analyses necessary to define modifications to the discharge-frequency curve, rating, and elevation-damage functions due to the plan. These analyses may require rainfall-runoff and routing models, statistical models, or hydraulics models.

(4) Derive the modified-condition damage-frequency curve, using the modified functions. Integrate the damage-frequency curve to compute expected damage with the changes.

(5) Solve (Equation 18-3) to compute inundation-reduction benefit.

(6) If catchment, channel, and economic conditions are dynamic, repeat steps 1-5 for each year of analysis.

d. The remainder of this chapter describes technical procedures for evaluating changes to the discharge-frequency curve and rating function as a consequence of flood-damage reduction plans.

18-4. Evaluating Reservoir and Detention Basins

a. Reservoir performance. A reservoir stores flood runoff and then releases it downstream to the channel over a longer period of time. This operation reduces the peak flow rate, resulting in lower water-surface elevation and less damage. The primary impact of the reservoir is modification of the discharge-frequency curve, as illustrated by Figure 18-2.

(1) The effectiveness of the reservoir depends on its capacity, location, and operation rules.

(2) The capacity limits the amount of runoff that can be collected and held for release at a nondamaging rate.

(3) The location governs the amount of runoff that the reservoir can control, since a reservoir will store only inflow from the area upstream. The reservoir operation rules determine the manner of release.

b. Reservoir modeling fundamentals. The performance of a reservoir or detention basin is evaluated with the routing procedures described in Chapter 9. The fundamental relationship used is the continuity relationship:

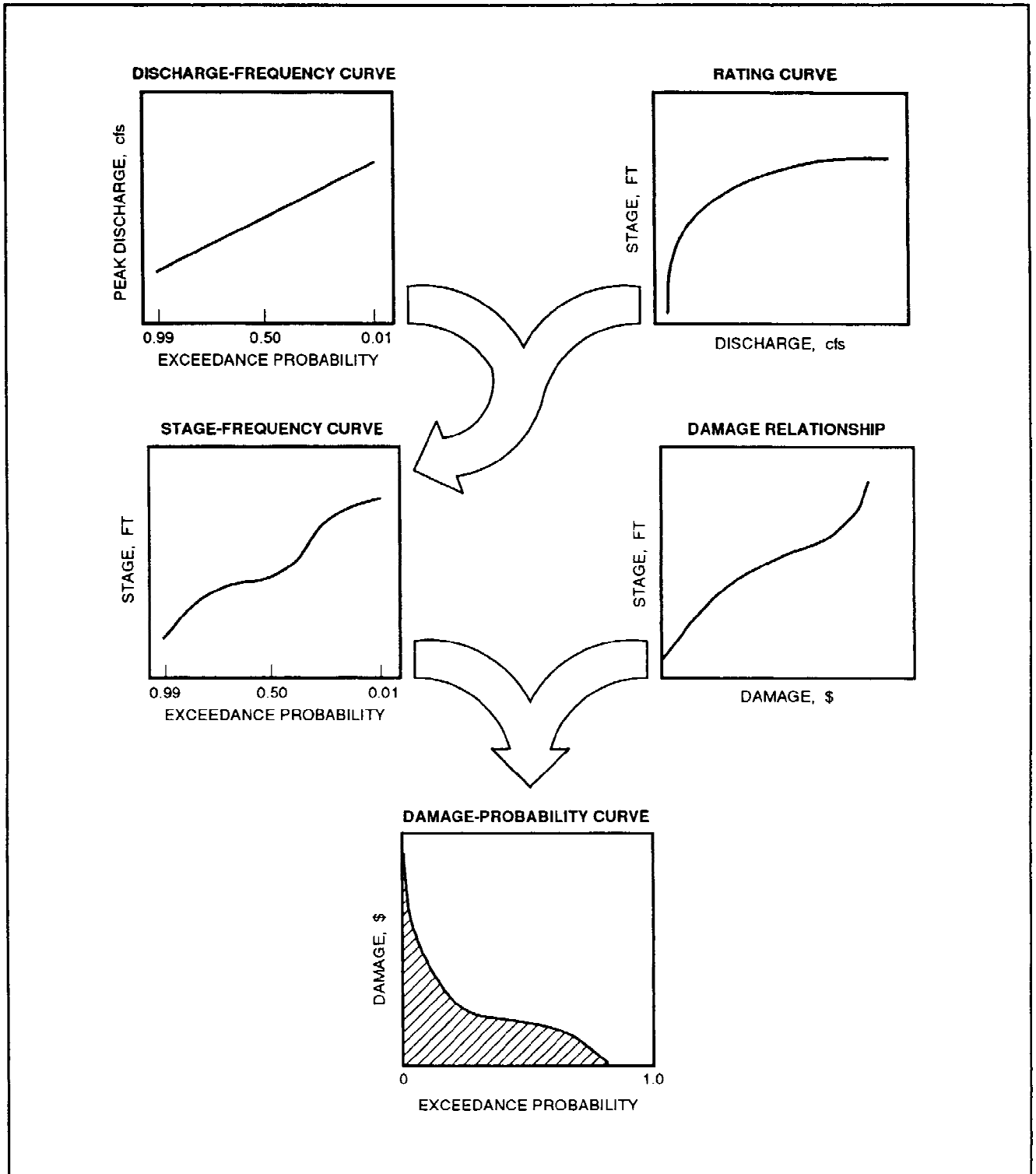

Figure 18-1. Derivation of damage-frequency curve from discharge-frequency curve, rating function, and elevation-damage function

Table 18-2
Evaluation Requirements of Damage Mitigation Measures

Category of Measure	Function(s) modified by measures in category		
	Discharge-probability	Elevation-discharge	Elevation-damage
Reservoir	X	-	-
Diversion	X	-	-
Watershed management	X	-	-
Channel alteration	X ¹	X	-
Levee/floodwall	X ¹	X	X
Floodplain management	-	-	X
Floodproofing	-	-	X
Flood warning and preparedness planning	-	-	X ²

¹ If floodplain storage altered significantly.

² Evaluation requires subjective analysis.

$$S_{t-1} + I_t dt - O_t dt = S_t \quad (18-4)$$

where

S_{t-1} = storage at the end of time interval $t - 1$

I_t = average reservoir inflow rate during interval t

dt = length of time interval

O_t = average reservoir outflow rate during interval t

S_t = reservoir storage at the end of interval t

This equation is solved recursively to determine the reservoir storage and release hydrographs. Solution requires specification of the initial volume in storage in the reservoir (S_t for $t = 0$), specification of the reservoir operation rules, and specification of the reservoir inflow hydrograph (I_t for all t).

(1) The initial storage selected for solution of Equation 18-4 depends on the reservoir condition to be evaluated. If the proposed reservoir has no permanent pool,

the initial storage is zero. If the impact of successive storms is of interest, the initial storage for each event, after the first, is the final storage of the preceding storm. If the reservoir is a multiple-purpose reservoir, a portion of the reservoir is allocated to flood control, and a portion is allocated to conservation. The reservoir operator strives to keep the conservation pool full, as releases or withdrawals from this pool satisfy water supply and energy demands. The operator tries to keep the flood-control pool empty. For analysis of reservoir operation during a flood, the initial storage depends on the success or likely success in meeting the goal. If the flood-control pool is empty, the total flood-control volume is available. Most reservoir flood-control operation studies assume this to be the case.

(2) The reservoir operation rules relate inflow, storage, and outflow. For a simple detention pond, the rules are fixed by the hydraulic characteristics of the structure. For example, for a simple detention pond with an uncontrolled conduit outlet and an ungated spillway, the operation rules can be determined via the orifice and weir equations. These equations will define the outflow as a function of reservoir water-surface elevation. With a site

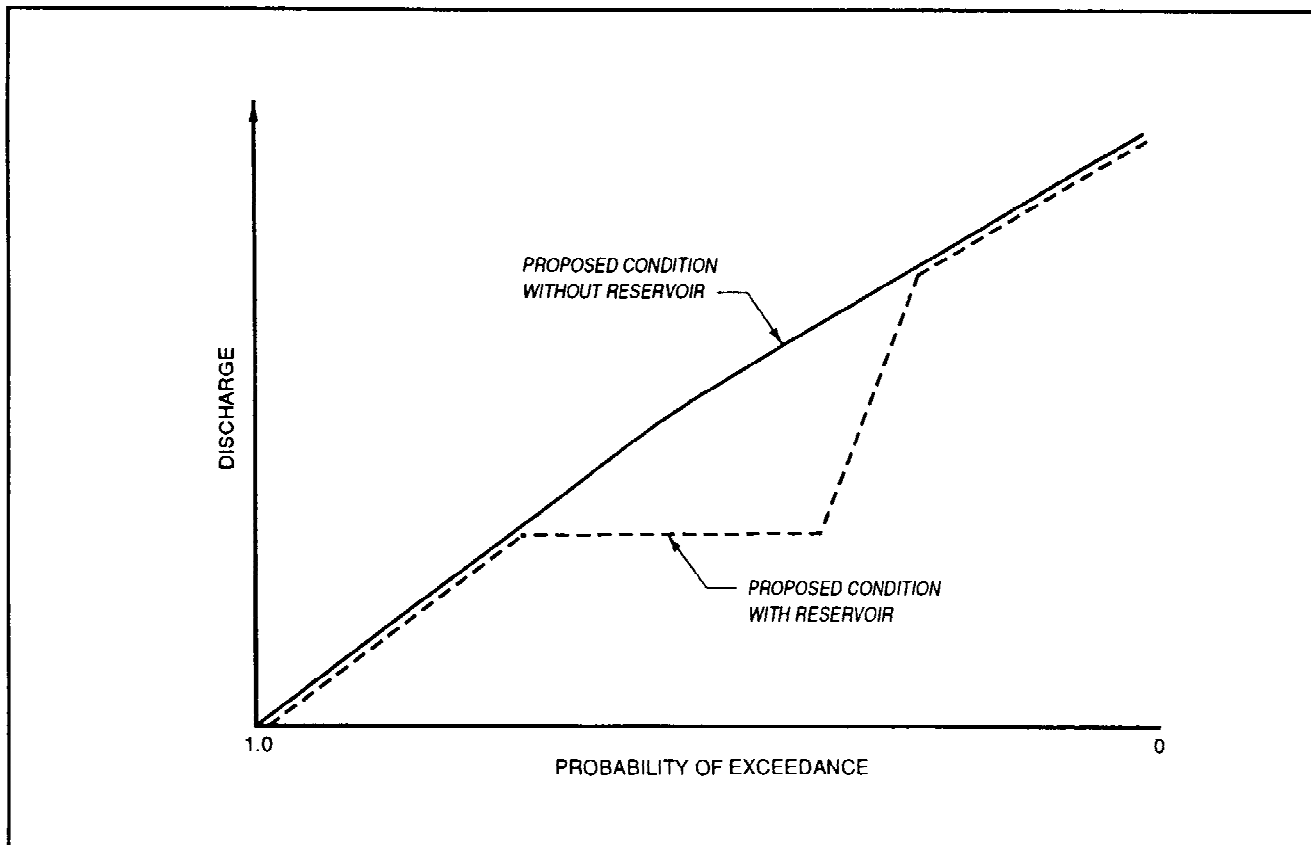

Figure 18-2. Discharge-frequency curve modification due to reservoir

elevation-area description, the elevation can be related to storage. This will permit solution of (Equation 18-4) and simulation of reservoir performance. For a gated flood-control reservoir, the rules are constrained by hydraulics and defined by economic, environmental, social, and political criteria.

(3) The reservoir inflow hydrograph depends on the study objective. If the goal is to define the modified discharge-frequency curve, one option is to evaluate reservoir performance with a long series of historical or synthetic inflows. The operation is simulated with the series to define the reservoir outflow. Statistical analysis procedures described in Chapter 12 are applied to the outflow series to estimate the modified discharge-frequency curve.

(4) Alternatively, the discharge-frequency curve can be estimated by evaluating performance for a limited number of historical events. The current, without-reservoir condition discharge-frequency curve is found with methods of Chapter 12. To estimate the modified

discharge-frequency curve, a runoff event is selected from the historical inflow record. The probability of the historical runoff peak corresponding to the event is determined from the discharge-frequency curve. The peak with the reservoir is estimated by simulation. This controlled peak discharge is assigned the same probability as the existing-condition peak. This is repeated for a range of runoff events to adequately define the modified discharge-frequency curve.

(5) The modified-condition discharge-frequency curve can be estimated also with hypothetical runoff events. Such a runoff event is developed from rainfall-runoff analysis with rain depths of known probability or from discharge duration-frequency analysis. In the first case, a design storm of specified probability is developed with procedures described in Chapter 13. The corresponding runoff hydrograph is computed with a rainfall-runoff model. This runoff hydrograph is inflow to the reservoir. In the second case, a balanced inflow hydrograph is developed. This balanced hydrograph has volumes for specified durations consistent with established

volume-duration-frequency relations. For example, a 0.01-probability balanced hydrograph is developed so the peak 1-hr volume equals the volume with probability 0.01 found through statistical analysis of runoff volumes. Likewise, the hydrograph's 24-hr volume equals the volume with probability 0.01. With either of the hypothetical inflow events, reservoir operation is simulated and the outflow peak is assigned the same probability as the inflow hydrograph. This procedure is repeated for a range of hypothetical rainfall events to adequately define the modified discharge-frequency curve. Strictly speaking, this is appropriate only if the reservoir has no permanent pool. Otherwise, the outflow depends on the inflow and the initial storage.

c. Dam-safety studies. The discharge-reduction benefit of a reservoir is accompanied by the hazard of dam failure. The impact of this failure can be estimated with hydraulics models described in EM 1110-2-1416 or with the routing models of Chapter 9 of this document. Three aspects of dam failure must be considered: formation of a breach, an opening in the dam as it fails; flow of water through this breach; and flow in the downstream channel. For analysis, the reservoir outflow hydrograph is computed with Equation 18-4 as before. However, the operating rules change with time as the breach grows. For convenience in analysis, a breach is assumed to be triangular, rectangular, or trapezoidal and to enlarge at a linear rate. At each instant that the breach is known, the flow through the breach can be determined with principles of hydraulics. Flow through the downstream channel is modeled with one of the routing models.

18-5. Evaluating Channel Alterations and Levees

a. Channel-alteration performance. Channel alterations include enlarging the channel, smoothing the channel, straightening the channel, and removing or minimizing obstructions in the channel. Enlarging the channel increases its flow-carrying capacity. The other alterations lessen the energy loss, thus permitting a given discharge to flow at a lesser depth. The primary impact of increasing the flow-carrying capacity or lessening the energy loss is modification of the rating function, as illustrated by Figure 18-3.

b. Channel-alteration modeling. The performance of a channel alteration is evaluated with river hydraulics models described in EM 1110-2-1413. These physically based models have physically based parameters that are modified to reflect changes to channel characteristics.

(1) The HEC-2 computer program (USACE 1982) is a well-known tool for evaluating channel alterations. This program implements a model of gradually varied steady flow in a rigid-boundary channel. That model uses the physical dimensions of the channel and indices of channel roughness directly in estimating flow depth. To evaluate the impact of proposed channel enlargement, the channel dimensions are modified in the program input to reflect the changes. Repeated solution of the gradually varied steady-flow equations with HEC-2 yields the rating function for a specified channel configuration.

(2) For modeling the impacts of changes in an alluvial channel, a movable-bed model should be used. Program HEC-6 (USACE 1990c) implements such a model.

c. Levee performance. A levee or floodwall reduces damage by reducing floodplain flooding depth. It does so by blocking overflow from the channel onto the floodplain when the capacity of the channel is exceeded. The rating function, as modified by a levee, is shown in Figure 18-4. A levee may also modify the discharge-frequency curve. The levee restricts flow onto the floodplain, eliminating the natural storage provided by the floodplain. This restriction may increase the discharge downstream of the levee for a specified probability. Further, as the natural channel is narrowed by the levee, the velocity may increase. This too may increase the discharge for a given probability.

d. Levee modeling.

(1) Introduction of a levee alters the effective channel cross section. The impact of this change can be determined with the physically based river hydraulics models. As with channel alteration, the impact of a levee can be determined by modifying the parameters which describe the channel dimensions. Repeated application of the model with various discharge magnitudes yields the rating function for a specified levee configuration.

(2) Modifications to the discharge-frequency curve due to a levee are identified with the river hydraulics models or with routing models described in Chapter 9. Either models the impact of storage on the discharge hydrograph and will reflect the loss of this storage. For example, the modified puls routing model determines the channel outflow hydrograph with a relationship of channel discharge to channel storage. A levee will reduce the channel storage for discharge magnitudes that exceed the

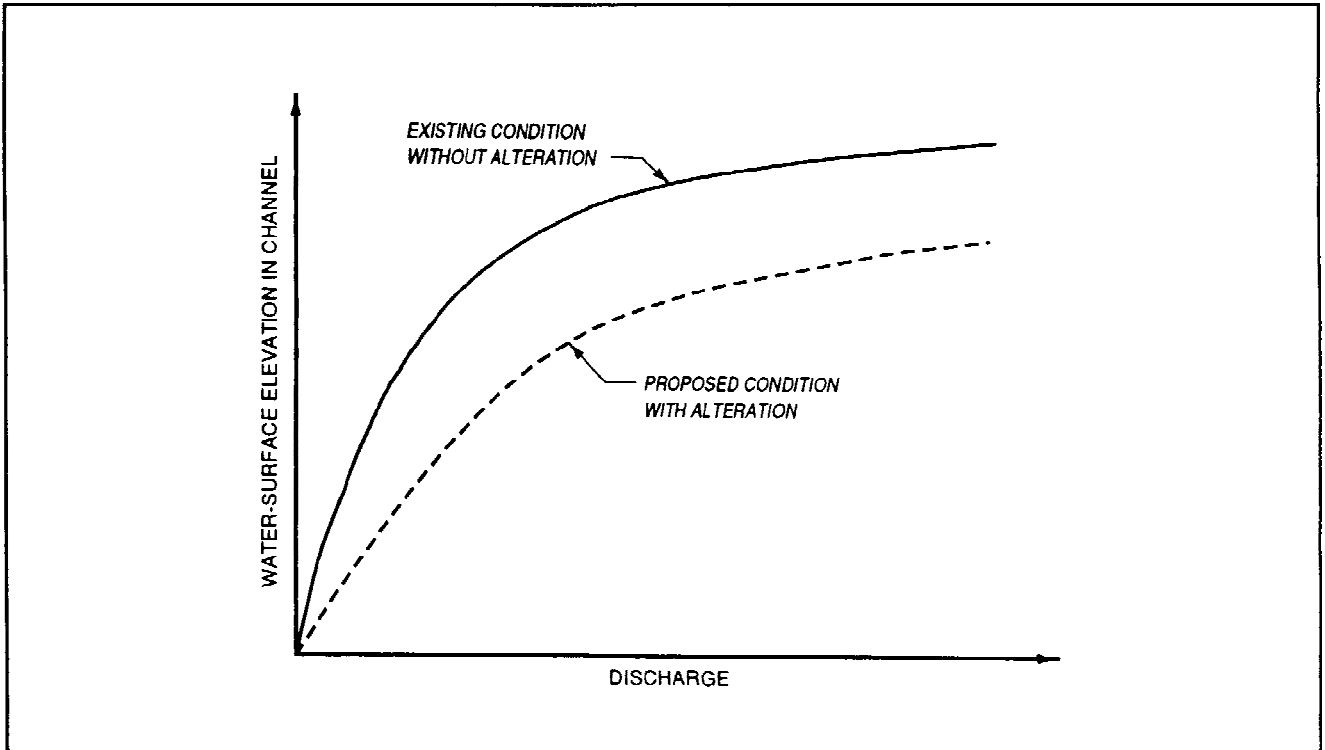

Figure 18-3. Rating function modification due to channel alteration

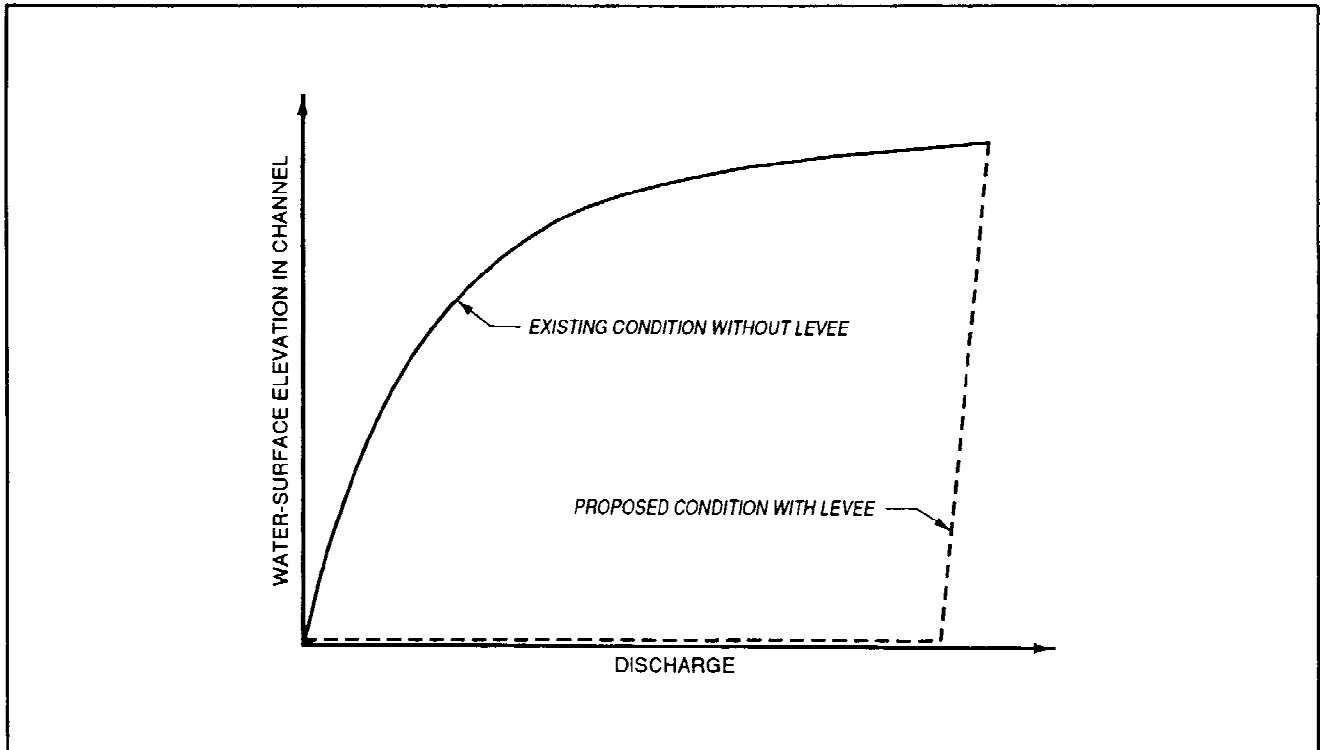

Figure 18-4. Rating function modification due to levee

channel capacity. Historical or hypothetical runoff hydrographs can be routed with the selected model to determine discharge peaks with the proposed levee.

e. Interior drainage. A levee or floodwall blocks the natural drainage of local runoff into the channel. This local runoff may cause flooding and must be considered in levee planning. Rainfall-runoff and routing models described in this document can be used to estimate the volume and time distribution of local runoff. Facilities for managing the water are described in EM 1110-2-1413. Often, a detention pond is used to store the interior drainage. The water is pumped from the pond into the channel. The performance of the pond can be simulated with routing models similar to those used for analysis of a reservoir or detention pond. Analysis procedures are described in detail in EM 1110-2-1416.

18-6. Evaluating Other Alternatives

a. Diversion. A diversion reduces the peak flow downstream of its location by reducing the volume of water flowing in a channel reach. This discharge reduction causes the discharge-frequency curve to be modified

as illustrated by Figure 18-5. Figure 18-6 is a plan view of a diversion. This diversion includes a bypass channel and a control structure. The control structure could be a simple overflow weir, a pipe through an embankment, or a gated, operator-controlled weir. When the flow rate in the main channel reaches a threshold, the control structure diverts a portion of the flow into the bypass channel. The volume and flow rate in the main channel is reduced, thus eliminating or reducing damage to the downstream property. Downstream, the bypass and the main channel join. There, the diverted water flows into the main channel.

(1) The performance of a diversion is evaluated with routing models described in Chapter 9 of this document. At the control structure, a hydraulics model estimates the distribution of flow into the bypass and flow in the main channel. This model may be as complex as the 2-D models described in EM 1110-2-1416 or as simple as a rating curve, based on 1-D steady-flow analysis, which defines diversion-channel flow as a function of main-channel flow. Passage of flow in the diversion channel and in the main channel is modeled with a routing model, such as the puls model.

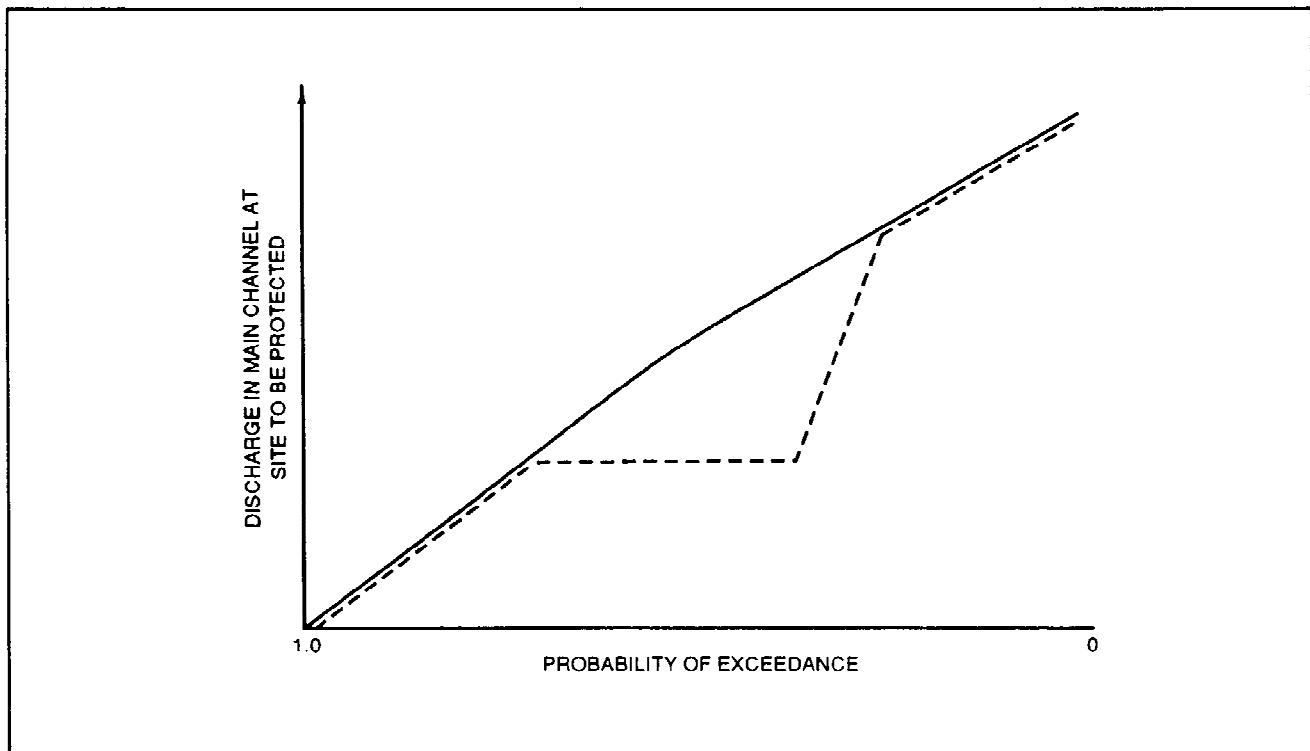

Figure 18-5. Discharge-frequency curve modified due to diversion

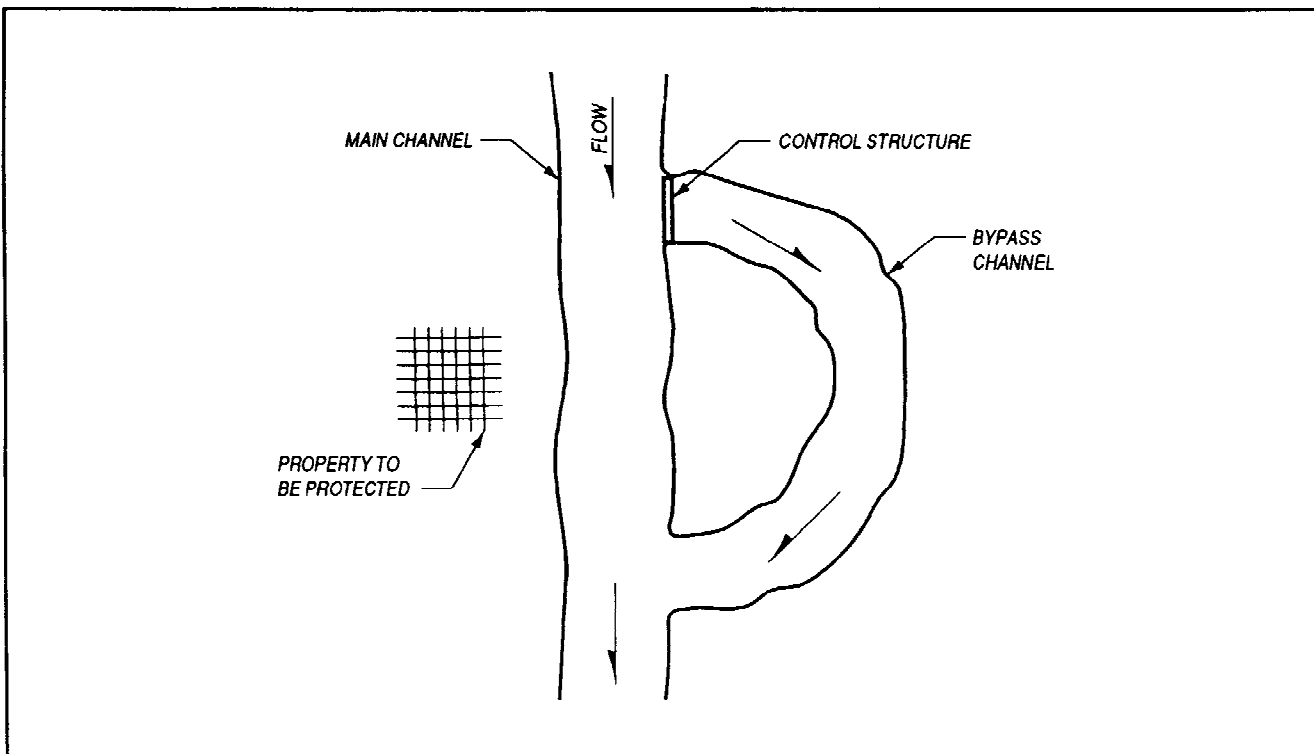

Figure 18-6. Plan view of diversion

(2) The impact of a diversion on the discharge-frequency curve can be evaluated via period-of-record analysis or simulation of selected events. With the period-of-record analysis, the historical discharge time series is analyzed to estimate channel flow when the proposed diversion operates. The resulting modified main-channel discharge time series is analyzed with statistical procedures to define the discharge-frequency curve. Otherwise, operation of the diversion with selected historical or hypothetical runoff hydrographs can be simulated. As with a reservoir, the resulting peaks are assigned probabilities equal the probabilities of the peaks without the diversion. For small events, the diversion has little or no impact on the discharge-frequency curve, since little or no water is diverted from the main channel. As the discharge magnitude increases, the diversion functions and diverts water up to its capacity. For larger events, the discharge reduction possible is constrained by the capacity of the diversion.

b. Watershed management. Watershed management includes vegetation and crop management, terracing and contour plowing, and drainage control. Whereas urbanization in a catchment increases the volume and speeds

runoff, these measures decrease the volume and/or slow the runoff.

(1) Vegetation and crop management ensure that land is covered with vegetation during the rainy season. This increases infiltration by impeding flow and making the soil more permeable.

(2) Terracing and contour plowing alter the shape of catchment surfaces, increasing storage, slowing flow, and increasing infiltration.

(3) Storm drainage control intercepts runoff and diverts or detains it, much like a reservoir or detention basin does. This reduces the runoff peak by spreading the runoff volume over a longer time period.

(4) The impact of watershed management measures is evaluated with the same procedures used to evaluate catchment and conveyance-system changes. A statistical model may be used with predictive equations for the model parameters. These predictive equations must include terms descriptive of watershed management modifications. Otherwise, the impacts of watershed

management may be predicted with a rainfall-runoff model. As described in paragraph 18-2, such a model permits evaluation of changes to runoff hydrographs. Through period-of-record analysis or by simulating selected historical or hypothetical events, the modified-condition discharge frequency curve can be estimated.

c. Floodplain management. Floodplain management decreases future damage by reducing vulnerability of future development. This may be accomplished with land-use ordinances, subdivision regulations, zoning laws, building codes, or real estate statutes.

(1) A floodplain land-use ordinance could restrict land uses that are dangerous due to water or erosion hazards. This will change the future elevation-damage function.

(2) Floodplain management may also modify the future discharge-frequency curves and future rating functions. For example, if future development in the floodplain is restricted, the impervious area may increase as old structures are razed and land is returned to a natural state. The impact of such modification can be evaluated using procedures described in paragraph 18-2.

Appendix A References

A-1. Required Publications

ER 1105-2-100

Guidance for Conducting Civil Works Planning Studies

ER 1110-2-1150

Engineering and Design for Civil Works Projects

EM 1110-2-1406

Runoff from Snowmelt

EM 1110-2-1411

Standard Project Flood Determinations

EM 1110-2-1413

Hydrologic Analysis of Interior Areas

EM 1110-2-1415

Hydrologic Frequency Analysis

EM 1110-2-1416

River Hydraulics

Abbot et al. 1986

Abbot, M. B., Bathurst, J. C., Cunge, J. A., O'Connell, P. E., and Rasmussen, J. 1986. "Introduction to the European Hydrological System - Systeme Hydrologique Europeen, 'SHE': history and philosophy of a physically-based distributed modelling system," *Journal of Hydrology*, Vol 87, pp 45-49.

Abramowitz and Stegun 1965

Abramowitz, M., and Stegun, I. A. 1965. *Handbook of Mathematical Functions*, U.S. Government Printing Office, Washington, DC.

Ahuja et al. 1988

Ahuja, L. R., Bruce, R. R., Cassel, D. K., and Rawls, W. J. 1988. "Simpler Field Measurement and Estimation of Soil Hydraulic Properties and Their Spatial Variability for Modeling." *ASAE Proceedings, Modeling Agricultural Forest and Rangeland Hydrology*, Pub 07-88, St. Joseph, MO.

Anderson 1975

Anderson, E. A. 1975. "National Weather Service River Forecast System - Snow Accumulation and Ablation

Model," National Oceanic and Atmospheric Administration Tech. Memo, NWS HYDRO-17, National Weather Service, Silver Springs, MD.

Aron, Miller, and Lakatos 1977

Aron, G., Miller, A. C., and Lakatos, D. F. 1977. "Infiltration Formula Based on SCS Curve Number," *Journal of the Irrigation and Drainage Division, American Society of Civil Engineers*, New York

Bear 1979

Bear, J. B. 1979. *Hydraulics of Groundwater*, McGraw-Hill International Book Company, New York.

Benjamin and Cornell 1970

Benjamin, J. R., and Cornell, C. A. 1970. *Probability, Statistics, and Decision for Civil Engineers*. McGraw-Hill Book Co., New York.

Brakensiek 1977

Brakensiek, D. L. 1977. Estimating the Effective Capillary Pressure in the Green and Ampt Infiltration Equation, *Water Resource Research*, Vol 13, No. 3, pp 680-682.

Brakensiek and Onstad 1988

Brakensiek, D. L., and Onstad, C. A. 1988. "Parameter Estimation of the Green and Ampt Infiltration Equation," *Water Resource Research*, Vol 13, No. 6, pp 1009-1012.

Brooks and Corey 1964

Brooks, R. H., and Corey, A. T. 1964. "Hydraulic Properties of Porous Media," *Colorado State University Hydrology Paper No. 3*, Fort Collins, CO.

Brunner 1989

Brunner, G. W. 1989. "Muskingum-Cunge Channel Routing," *Lecture Notes, Hydrologic Engineering Center, U.S. Army Corps of Engineers*, Davis, CA.

Chow 1951

Chow V. T. 1951. "A General Formula For Hydrologic Frequency Analysis," *Transactions, American Geophysical Union*, Vol 32, No. 2, pp 231-237.

Chow, Maidment, and Mays 1988

Chow, V. T., Maidment, D. R., and Mays, L. W. 1988. *Applied Hydrology*. McGraw-Hill, New York.

Clark 1945

Clark, C. O. 1945. "Storage and the Unit Hydrograph." *Transactions of the American Society of Civil Engineers*, Vol 110, pp 1419-1446.

Crawford and Linsley 1966

Crawford, Norman H., and Linsley, Ray K. 1966. "Digital Simulation in Hydrology: Stanford Watershed Model IV," Civil Engineering Technical Report No. 39, Stanford University, Palo Alto, CA.

Crippen 1982

Crippen, J. R. 1982. "Envelope Curves for Extreme Flood Events," *Hydraulic Journal*, American Society of Civil Engineers, Vol 108, No. HY10, pp 1208-1212.

Crippen and Bue 1977

Crippen, J. R., and Bue, Conrad D. 1977. "Maximum Floodflows in the Conterminous United States," Water Supply Paper 1887, U.S. Geological Survey, Washington, DC.

Cunge 1969

Cunge, J. A. 1969. "On the Subject of a Flood Propagation Computation Method (Muskingum Method)," *Journal of Hydraulic Research*, Vol 7, No. 2 pp 205-230.

Dawdy, Lichty, and Bergman 1972

Dawdy, D. R., Lichty, R. W., and Bergman, J. M. 1972. "A rainfall-runoff Simulation Model for Estimation of Flood Peaks for Small Drainage Basins," Geological Survey Professional Paper, 506-B, U.S. Government Printing office, Washington, DC.

DeBarry and Carrington 1990

DeBarry, P. A., and Carrington, J. T. 1990. "Computer Watersheds." *Civil Engineering*, Vol 6, No. 7, pp 68-70.

Eagleson 1970

Eagleson, P. S. 1970. *Dynamic Hydrology*. McGraw-Hill Book Company, New York.

Engman 1986

Engman, E. T. 1986. "Roughness Coefficients for Routing Surface Runoff," *Journal of Irrigation and Drainage*, American Society of Civil Engineers, Vol 112, No. 4, pp 39-53.

Federer and Lash 1978

Federer, Anthony C., and Lash, Douglas. 1978. "Brook: A Hydrologic Simulation Model for Eastern Forests, Durham, New Hampshire," University of New Hampshire,

Water Resource Research Center, Research Report No. 19.

Ford, Morris, and Feldman 1980

Ford, D. T., Morris, E. C., and Feldman, A. D. 1980. "Corps of Engineers Experience With Automatic Calibration of a Precipitation-Runoff Model," *Water and Related Land Resource Systems*, Y. Haimes and J. Kindler, ed., Pergamon Press, New York.

Fread 1982

Fread, D. L. 1982. "Flood Routing: A Synopsis of Past, Present, and Future Capabilities," *Rainfall-Runoff Relationships*, Proceedings of the International Symposium on Rainfall-Runoff Modeling. Mississippi State University, Mississippi State, MS.

Gray and Male 1981

Gray, D. M., and Male, D. H. 1981. *Handbook of Snow*, Pergamon Press, New York.

Haan 1977

Haan, C. T. 1977. *Statistical Methods in Hydrology*, Iowa State University Press, Ames, IA.

Hamon 1961

Hamon, W. R. 1961. "Estimating Potential Evapotranspiration: Proceedings of American Society of Civil Engineers," *Journal of the Hydraulic Division*, Vol 87, HY3, pp 107-120.

Hathaway 1945

Hathaway, G. A. 1945. "Symposium on Military Airfields - Design of Drainage Facilities," *Transactions, American Society of Civil Engineers*, Vol 110, pp 697-733.

Henderson 1966

Henderson, F. M., 1966. *Open Channel Flow*, MacMillan Publishing Co. Inc., New York, New York.

Hershfield 1961

Hershfield, D. M. 1961. "Rainfall frequency atlas of the United States for durations from 30 minutes to 24 hours and return periods from 1 to 100 years," Technical Paper No. 40, superseded by Hydrometeorological Report No. 35, U.S. Department of Commerce, National Weather Service, Silver Springs, MD.

Hjelmfelt 1980

Hjelmfelt, A. T. 1980. "Curve Number Procedure as an

Infiltration Method," *Journal of the Hydrology Division*, American Society Civil Engineers, HY6, pp 1107-1111.

Holtan et al. 1975

Holtan, H. N., Stitner, G. J., Henson, W. H., and Lopez, N. C. 1975. "USDAHL-74 revised model of watershed hydrology," Technical Bulletin No. 1518, Agricultural Research Service, U.S. Department of Agriculture, Washington, DC.

Horton 1919

Horton, R. E. 1919. "Rainfall Interception," *Monthly Weather Review*, Vol 47, pp 603-623.

Horton 1935

Horton, R. E. 1935. "Surface Runoff Phenomena; Part I, Analyses of the Hydrograph," Hydrology Laboratory, Pub 101, Edwards Feathers, Inc. Ann Arbor, MI.

Horton 1945

Horton, R. E. 1945. "Erosional Development of Streams and Their Drainage Basins: Hydrophysical Approach to Quantitative Morphology." *Bull. Geol. Soc. of America*, Vol 56, pp 275-370.

Huff 1967

Huff, F. A. 1967. "Time Distribution of Rainfall in Heavy Storms," *Water Resources Research*, Vol 3, No. 4, pp 1007-1019.

Jensen and Haise 1963

Jensen, M. E., and Haise, H. R. 1963. "Estimating Evapotranspiration Form Solar Radiation: Proc. of the American Society of Civil Engineers, *Journal of Irrigation and Drainage*, Vol 89, No. IR4, pp 15-41.

Kite 1977

Kite, G. W. 1977. "Frequency and Risk Analysis in Hydrology," *Water Resources Publications*, Ft. Collins, CO.

Leopold 1968

Leopold, Luna. 1968. "Hydrology for urban land planning - a guidebook on the hydrologic effects of urban land use," *Geological Survey Circular 554*. U.S. Geological Survey, Washington, DC.

Lettenmaier 1984

Lettenmaier, D. P. 1984. "Limitations on seasonal forecast accuracy. *J. Water Res. Plng. and Mgmt. Div.*, American Society Civil Engineers, Vol 110, pp 255-269.

Li, Stevens, and Simons 1976

Li, R., Stevens, M. A., and Simons, D. B. 1976. "Solutions to Green-Ampt Infiltration Equation," *Journal of Irrigation and Drainage Division*, American Society Civil Engineers, IR2, pp 239-248.

Linden 1979

Linden, R. L. 1979. A model to predict soil water storage as affected by tillage practices. Thesis presented to the University of Minnesota, at Minneapolis, MN.

Linsley 1986

Linsley, R. K. 1986. "Flood estimates: how good are they?" *Water Resources Research*, Vol 22, No. 9, pp 159S-164S.

Linsley, Kohler, and Paulhus 1975

Linsley, R. K., Kohler, M. A., and Paulhus, J. L. H. 1975. *Hydrology for Engineers*, McGraw-Hill, New York.

Loague and Freeze 1985

Loague, K. M., and Freeze, R. A. 1985. "A Comparison of Rainfall-runoff Modeling Techniques on Small Upland Catchments," *Water Resources Research*, AGU, Vol 21, No. 2, pp 229-248.

Loucks, Stedinger, and Haith 1981

Loucks, D. P., Stedinger, G., and Haith, D. 1981. *Water Resources Systems Planning and Analysis*, Prentice-Hall, Englewood Cliffs, NJ.

Matthai 1969

Matthai, H. F. 1969. "Flood of June 1965 in South Platte River Basin, Colorado," Water Supply Paper 1850-B, *U.S. Geological Survey*, Washington, DC.

McCuen 1989

McCuen, R. H. 1989. *Hydrologic Analysis and Design*, Prentice Hall, Englewood Cliffs, NJ.

McCuen and Snyder 1986

McCuen, R. H., and Snyder, W. M. 1986. *Hydrologic modeling: Statistical Methods and Applications*, Prentice-Hall, Englewood Cliffs, NJ.

McCuen, Rawls, and Brakensiek 1981

McCuen, R. H., Rawls, W. J., and Brakensiek, D. L. 1981. "Statistical Analysis of the Brooks-Corely and the Green-Ampt Parameters Across Soil Textures." *Water Resources Research*, Vol 17, No. 4, pp 1005-1013.

Mein and Larson 1973

Mein, R. G., and Larson, C. L. 1973. "Modeling Infiltration During Steady Rain," *Water Resources Research*, Vol 2, pp 384-394.

Miller 1963

Miller, J. F. 1963. "Probable Maximum Precipitation and Rainfall-Frequency Data for Alaska for Areas to 400 Square Miles," Technical Paper No. 47, U.S. Department of Commerce, Weather Bureau, Washington, DC.

Miller and Cunge 1975

Miller, W. A., and Cunge, J. A. 1975. "Simplified Equations of Unsteady Flow," *Unsteady Flow in Open Channels*, Vol I, K. Mahmood and V. Yevjevich, ed., pp 183-249.

Miller, Frederick, and Tracey 1973

Miller, J. F., Frederick, R. H., and Tracey, R. J. 1973. "Precipitation-Frequency Atlas of the Western United States, Volume I, Montana; Volume II, Wyoming; Volume III, Colorado; Volume IV, New Mexico; Volume V, Idaho; Volume VI, Utah; Volume VII, Nevada; Volume VIII, Arizona; Volume IX, Washington; Volume X, Oregon; Volume XI, California," U.S. Department of Commerce, National Weather Service, NOAA Atlas 2, Silver Springs, MD.

Mockus 1957

Mockus, Victor. 1957. "Use of Storm and Watershed Characteristics in Synthetic Hydrograph Analysis and Application," U.S. Department of Agriculture, Soil Conservation Service, Latham, MD.

Mockus 1964

Mockus, Victor. 1964. Letter from Victor Mockus to Orrin Ferris, March 5, U.S. Department of Agriculture, Soil Conservation Service, Latham, MD.

Monteith 1965

Monteith, J. L. 1965. "Evaporation and Environment," *Symp. Soc. Exp. Biol.*, Vol 119, pp 205-234.

Morel-Seytoux 1980

Morel-Seytoux, H. J. 1980. "Application of Infiltration Theory in Hydrologic Practice, HYDROWAR Program," CEP80-81HJM2, Engineering Research Center, Colorado State University, Fort Collins, CO.

Morel-Seytoux and Verdin 1981

Morel-Seytoux, H. J., and Verdin, J. P. 1981. "Extension of the Soil Conservation Service Rainfall-runoff Methodology for Ungaged Watersheds," U.S. Federal Highway

Administration Office of Research and Development, No. FHWA/RD-81/060, Washington, DC.

Musgrave 1955

Musgrave, G. W. 1955. "How much of the Rain Enters the Soil," In *Water: U.S. Department of Agricultural Yearbook*, pp 151-159, Washington, DC.

Nash 1957

Nash, J. E. 1957. "The form of the instantaneous unit hydrograph," *International Association of Science and Hydrology*, Pub. 45, Vol 3, pp 114-121.

Overton and Meadows 1976

Overton, D. E., and Meadows, M. E. 1976. *Stormwater modeling*, Academic Press, New York.

Palmer 1946

Palmer, V. J. 1946. "Retardance Coefficients for Low Flow in Channels Lined with Vegetation," *Transactions of the American Geophysical Union*, Vol 27, No. II, pp 187-197.

Pilgrim 1986

Pilgrim, D. H. 1986. "Bridging the gap between flood research and design practice," *Water Resources Research*, Vol 22, No. 9, pp 165S-176S.

Pilgrim and Cordery 1975

Pilgrim, D. H., and Cordery, I. 1975. "Rainfall temporal patterns for design floods," *Journal Hydraulics Division*, American Society of Civil Engineers, Vol 101, No. HY1, pp 81-95.

Ponce 1983

Ponce, V. M. 1983. "Development of Physically Based Coefficients for the Diffusion Method of Flood Routing," Final Report to the USDA, Soil Conservation Service, Lanham, MD.

Ponce and Yevjevich 1978

Ponce, V. M., and Yevjevich, V. 1978. "Muskingum-Cunge Method With Variable Parameters," *Journal Hydraulics Division*, American Society of Civil Engineers, Vol 104, No. HY12, pp 1663-1667.

Ragan and Dura 1972

Ragan, R. M., and Dura, J. O. 1972. "Kinematic Wave Nomenclature for Times of Concentration," *Journal Hydraulics Division*, American Society of Civil Engineers, Vol 10, No. HY98, pp 1765-1771.

Rallison and Miller 1981

Rallison, R. E., and Miller, N. 1981. "Past, present and future SCS runoff procedure, in *Rainfall-Runoff Relationships*," *Proc. of the Inter. Symp. on rainfall-runoff Modeling, May 18-21, Mississippi State University, Water Resource Publications*, Littleton, CO, pp 355-364.

Rawls and Brakensiek 1982

Rawls, W. J., and Brakensiek, D. L. 1982. "Estimating Soil Water Retention from Soil Properties," *Journal Irrigation Drainage Division*. American Society of Civil Engineers, Vol 108, No. IR2, pp 166-171.

Rawls and Brakensiek 1983

Rawls, W. J., and Brakensiek, D. L., 1983. "A Procedure to Predict Green and Ampt Infiltration Parameters," *Proceedings of the American Society of Agricultural Engineers Conference on Advances in Infiltration*, American Society of Agricultural Engineers, St. Joseph, MI, pp 102-112.

Rawls and Brakensiek 1985

Rawls, W. J., and Brakensiek, D. L. 1985. "Prediction of Soil Water Properties for Hydrologic Modeling," *Proceedings of the American Society of Civil Engineers Watershed Management in the Eighties Symposium*, American Society of Civil Engineers, New York, pp 293-299.

Rawls and Brakensiek 1989

Rawls, W. J., and Brakensiek, D. L. 1989. "Estimation of Soil Water Retention and Hydraulic Properties," *Unsaturated Flow in Hydrologic Modeling, Theory and practice*, H. J. Morel-Seyton, ed., NATO ASI series, series c: Mathematical and physical sciences, - Vol 275.

Rawls, Brakensiek, and Savabi 1988

Rawls, W. J., Brakensiek, D. L., and Savabi, R. 1988. "Infiltration Parameters for Rangeland Soils," *Journal Range Management*, Vol 42, pp 139-142.

Rawls, Brakensiek, and Saxton 1982

Rawls, W. J., Brakensiek, D. L., and Saxton, K. E. 1982. "Estimation of Soil Water Properties," *Transactions American Society of Agricultural Engineers*, St. Joseph, MI, Vol 25, No. 5, pp 1316-2320.

Rawls, Brakensiek, and Soni 1983

Rawls, W. J., Brakensiek, D. L., and Soni, B. 1983. "Agricultural Management Effects on Soil Water Process, Part I: Soil Water Retention and Green-Ampt Infiltration

Parameters," *Transactions American Society of Agricultural Engineers*, pp 1747-1752.

Richards 1931

Richards, L. A. 1931. "Capillary Conduction of Liquids through Process Mediums," *Physical Vol 1*, pp 318-333.

Russell, Kenning, and Sunnell 1979

Russell, S. O., Kenning, B. F. I., and Sunnell, G. J. 1979. "Estimating Design Flows for Urban Drainage," *Journal Hydraulics Division*, American Society of Civil Engineers, Vol 105, No. HY1, pp 43-52.

Sabol 1988

Sabol, G. V. 1988. "Clark Unit Hydrograph and R-parameter Estimation," *Journal Hydraulics Engineering*, American Society of Civil Engineers, Vol 114, No. 1, pp 103-111.

Sauer et al. 1983

Sauer, V. B., Thomas, W. O., Stricker, V. A., and Wilson, K. V. 1983. "Flood Characteristics of Urban Watersheds in the United States," *Water-supply Paper 2207*, U.S. Geological Survey, Washington, DC.

Schomaker 1966

Schomaker, C. E. 1966. "The Effect of Forest and Pasture on the Disposition of Precipitation, Maine Farm Research," Maine Agricultural Experiment Station, University of Maine, Orono, ME.

Skaggs and Khaleel 1982

Skaggs, R. N., and Khaleel, R. 1982. "Infiltration In Hydrologic Modeling of Small Watersheds," *American Society of Agricultural Engineers Monog. No. 5*, Am. Soc. Agr. Engrs., St. Joseph, MI, pp 4-166.

Smart 1972

Smart, J. S. 1972. "Channel networks," *Advances in Hydroscience*, Academic Press, Orlando, FL, Vol 8, pp 305-346.

Smith 1976

Smith, R. E. 1976. "Approximations for Vertical Infiltration Rate Patterns," *Transactions American Society of Agricultural Engineers*, Vol 19, No. 3, pp 505-509.

Snyder 1938

Snyder, F. F. 1938. "Synthetic Unit-graphs," *Trans. Amer. Geophys. Union*, Vol 19, pp 447-454.

Soil Conservation Service 1972

Soil Conservation Service. 1972. *National Engineering Handbook, Section 4*. U.S. Department of Agriculture, Washington, DC.

Soil Conservation Service 1986

Soil Conservation Service. 1986. "Urban Hydrology for Small Watersheds," Technical Release 55, U.S. Department of Agriculture, Washington, DC.

Thorntwaite 1954

Thorntwaite, C. W. 1954. "A reexamination of the concept and measurement of potential evapotranspiration," Publ. in Climat., V7.

U.S. Army Corps of Engineers 1956

U.S. Army Corps of Engineers. 1956. "Snow Hydrology," North Pacific Division, Portland, OR.

U.S. Army Corps of Engineers 1979

U.S. Army Corps of Engineers. 1979. "Introduction and Application of Kinematic Wave Routing Techniques Using HEC-1," Training Document No. 10, Hydrologic Engineering Center, Davis, CA.

U.S. Army Corps of Engineers 1982

U.S. Army Corps of Engineers. 1982. "Hydrologic Analysis of Ungaged Watersheds Using HEC-1," Training Document No. 15, Hydrologic Engineering Center, Davis, CA.

U.S. Army Corps of Engineers 1984a

U.S. Army Corps of Engineers. 1984a. "Expected Annual Flood Damage Computation, User's Manual," Hydrologic Engineering Center, Davis, CA.

U.S. Army Corps of Engineers 1984b

U.S. Army Corps of Engineers. 1984b. "HMR52, Probable Maximum Storm Computation (Eastern U.S.), User's Manual," Hydrologic Engineering Center, Davis, CA.

U.S. Army Corps of Engineers 1986

U.S. Army Corps of Engineers. 1986. "Accuracy of Computed Water Surface Profiles," Research Document No. 26, Hydrologic Engineering Center, Davis, CA.

U.S. Army Corps of Engineers 1987

U.S. Army Corps of Engineers. 1987. "Streamflow Synthesis and Reservoir Regulation Model (SSARR): User Manual," Program No. 724, North Pacific Division, Portland, OR.

U.S. Army Corps of Engineers 1988

U.S. Army Corps of Engineers. 1988. *Proceedings of a Seminar on Flood Damage Reduction Reconnaissance - Phase Studies*, Hydrologic Engineering Center, Davis, CA.

U.S. Army Corps of Engineers 1989

U.S. Army Corps of Engineers. 1989. *Proceedings of a Hydrology and Hydraulics Conference on Functional and Safety Aspects of Corps Projects*, Hydrologic Engineering Center, Davis, CA.

U.S. Army Corps of Engineers 1990a

U.S. Army Corps of Engineers. 1990a. "HEC-1 Flood Hydrograph Package User's Manual," Hydrologic Engineering Center, Davis, CA.

U.S. Army Corps of Engineers 1990b

U.S. Army Corps of Engineers. 1990b. "HEC-2 Water Surface Profiles User's Manual," Hydrologic Engineering Center, Davis, CA.

U.S. Army Corps of Engineers 1990c

U.S. Army Corps of Engineers. 1990c. "HEC-6: Scour and Deposition in Rivers and Reservoirs, User's Manual," Hydrologic Engineering Center, Davis, CA.

U.S. Department of Agriculture 1986

U.S. Department of Agriculture. 1986. "Urban Hydrology for Small Watersheds," *Technical Release 55*, Soil Conservation Service, Washington, DC.

U.S. Department of Commerce 1947

U.S. Department of Commerce. 1947. "Thunderstorm Rainfall," Hydrometeorological Report No. 5, Weather Bureau, Office of Hydrologic Director, Silver Springs, MD.

U.S. Department of Commerce 1961

U.S. Department of Commerce. 1961. "Generalized Estimates of Probable Maximum Precipitation and Rainfall-Frequency Date for Puerto Rico and Virgin Islands," Technical Paper No. 42, Weather Bureau, Washington, DC.

U.S. Department of Commerce 1962

U.S. Department of Commerce. 1962. "Rainfall-Frequency Atlas of the Hawaiian Islands for Areas to 200 Square Miles," Technical Paper No. 43, Weather Bureau, Washington, DC.

U.S. Department of Commerce 1978

U.S. Department of Commerce. 1978. "PMP in East of the 105th Meridian," Hydrometeorological Report No. 51, National Oceanic and Atmospheric Administration, Office of Hydrology, National Weather Service, Silver Springs, MD.

U.S. Department of Commerce 1982

U.S. Department of Commerce. 1982. "Application of PMP East of the 105th Meridian," Hydrometeorological Report No. 52, National Oceanic and Atmospheric Administration, Office of Hydrology, National Weather Service, Silver Springs, MD.

U.S. Department of Commerce 1988

U.S. Department of Commerce. 1988. "PMP Between the 103rd Meridian and the Continental Divide," Hydrometeorological Report No. 55, National Oceanic and Atmospheric Administration, Office of Hydrology, National Weather Service, Silver Springs, MD.

U.S. Geological Survey 1983

U.S. Geological Survey. 1983. "Precipitation-Runoff Modelling System (PRMS): User's Manual," Water Resources Investigations Report 83-4238, U.S. Government Printing Office, Region No. 8, 779-344/9323, Washington, DC.

U.S. Water Resources Council 1967

U.S. Water Resources Council. 1967. "A Uniform Technique for Determining Flood Flow Frequencies," *Bulletin 15*, Washington, DC.

U.S. Water Resources Council 1976

U.S. Water Resources Council. 1976. "Guidelines for Determining Flood Flow Frequencies," *Bulletin 17*, Washington, DC.

U.S. Water Resources Council 1977

U.S. Water Resources Council. 1977. "Guidelines for Determining Flood Flow Frequencies," *Bulletin 17A*, Washington, DC.

U.S. Water Resources Council 1981

U.S. Water Resources Council. 1981. "Guidelines for Determining Flood Flow Frequencies," *Bulletin 17B*, Washington, D.C.

Viessman et al. 1977

Viessman Jr., W., Knapp, J.W., Lewis, G.L., Harbaugh, T.E. 1977. *Introduction to Hydrology*, Harper and Row, New York.

Waananen and Crippen 1977

Waananen, A.O., and Crippen, J.R. 1977. "Magnitude of Frequency of Floods in California," Water Resources Investigations 77-21, U.S. Geological Survey, Washington, DC.

Ward 1967

Ward, R.C. 1967. *Principles of Hydrology*, McGraw-Hill (Limited), London.

Woolhiser 1975

Woolhiser, D.A. 1975. "Simulation of Unsteady Overland Flow. Unsteady Flow In Open Channels," K. Mahmood and V. Yevjevich, ed., Water Resources Publications, Colorado State University, Fort Collins, CO.

Wright-McLaughlin Engineers 1969

Wright-McLaughlin Engineers. 1969. *Urban Storm Drainage Criteria Manual*. Denver Region Council of Governments, Denver, CO.

A-2. Related Publications

Burnash 1985

Burnash, R. J. 1985. "The Sacramento Watershed Model, Hydrologic Modelling for Flood Hazards," presented at Hydrologic Modelling for Flood Hazards Planning and Management, University of Colorado at Denver, California-Nevada River Forecast Center, National Weather Service, Sacramento, CA.

Chow 1964

Chow, V. T. 1964. "Snow and Snow Survey," *Handbook of Hydrology*, Section 10, New York.

Hjelmfelt 1986

Hjelmfelt, A. T. 1986. "Estimating Peak Runoff From Field-Size Watersheds," *Water Resources Bulletin*, American Water Resources Association, Vol 22, No. 2, pp 267-274.

National Oceanic and Atmospheric Administration

National Oceanic and Atmospheric Administration (NOAA). Atlas 2, "Precipitation-Frequency Atlas of the Western United States," NOAA Atlas 2, Office of Hydrology, National Weather Service, Silver Springs, MD.

National Oceanic and Atmospheric Administration

National Oceanic and Atmospheric Administration (NOAA), National Weather Service (NWS). Hydrometeorological Branch of the Office of Hydrology,

Hydrometeorological Report (HMR) Nos. 51 and 55, U.S. Department of Commerce (1978 and 1988).

National Oceanic and Atmospheric Administration

National Oceanic and Atmospheric Administration (NOAA), National Weather Service (NWS). Hydrometeorological Branch of the Office of Hydrology, Hydrometeorological Report (HMR) No. 52, U.S. Department of Commerce 1982.

National Oceanic and Atmospheric Administration

National Oceanic and Atmospheric Administration (NOAA), National Weather Service (NWS), Hydrometeorological Reports (HMR), NOAA Technical Report NWS 25.

Penman 1948

Penman, H. L. 1948. "Natural Evaporation from Open Water, Bare Soil and Grass," *Proc. Roy. Soc. (London)*, Ser. A, Vol 193, pp 120-145.

Ponce 1986

Ponce, V. M. 1986. "Diffusion Wave Modeling of Catchment Dynamics," *Journal of Hydraulics Division*, American Society of Civil Engineers, Vol 112, No. 8.

Strelkoff 1980

Strelkoff, T. 1980. "Comparative Analysis of Flood Routing Methods," Hydrologic Engineering Center, Davis, CA.

U.S. Army Corps of Engineers 1969

U.S. Army Corps of Engineers. 1969. "Lower Columbia River Standard Project Flood and Probable Maximum Flood, Memorandum Report," North Pacific Division, Portland, OR.

U.S. Army Corps of Engineers 1987

U.S. Army Corps of Engineers. 1987. "HECDSS, User's Guide and Utility Program Manuals," CPD-45, Hydrologic Engineering Center, Davis, CA.

U.S. Army Corps of Engineers 1989

U.S. Army Corps of Engineers. 1989. "Digest of Water Resources Policies and Authorities," Engineer Pamphlet 1165-2-1, Washington, DC.

U.S. Department of Commerce 1961

U.S. Department of Commerce. 1961. "PMP in California," Hydrometeorological Report No. 36, National Oceanic and Atmospheric Administration, Office of Hydrology, National Weather Service, Silver Springs, MD.

U.S. Department of Commerce 1966

U.S. Department of Commerce. 1966. "PMP in Northwestern States," Hydrometeorological Report No. 43, National Oceanic and Atmospheric Administration, Office of Hydrology, National Weather Service, Silver Springs, MD.

U.S. Department of Commerce 1972

U.S. Department of Commerce. 1972. "PMP in Colorado River and Great Basin Drainage," Hydrometeorological Report No. 49, National Oceanic and Atmospheric Administration, Office of Hydrology, National Weather Service, Silver Springs, MD.

U.S. Department of Commerce 1980

U.S. Department of Commerce. 1980. "Seasonal Variation of PMP East of the 105th Meridian," Hydrometeorological Report No. 53, National Oceanic and Atmospheric Administration, Office of Hydrology, National Weather Service, Silver Springs, MD.

U.S. Water Resources Council 1983

U.S. Water Resources Council. 1983. *Economic and Environmental Principles and Guidelines for Water and Related Land Resources Implementation Studies*. U.S. Government Printing Office, Washington, DC.

Appendix B Hydrologic Engineering Management Plan for Flood Damage Reduction Feasibility-Phase Studies

B-1. Introduction

This generic HEMP is appropriate for hydrologic analysis associated with a typical USACE flood damage reduction feasibility study. The intent of the hydrologic engineering analysis would be to determine existing and future stage-frequency relationships at all key points in the study area, along with flooded area maps by frequency. This analysis would be performed for without-project and for various flood reduction components which are considered feasible for relief of the flood problem.

B-2. Preliminary Investigations

This initial phase includes reviewing literature of previous reports, obtaining the available data, and requesting additional information needed to perform the investigation.

a. Initial preparation.

(1) Confer with the other disciplines involved in the study to determine the objectives, the hydrologic engineering information requirements of the study for other disciplines, study constraints, etc.

(2) Scope study objectives and purpose.

(3) Review available documents.

(a) Previous USACE work.

(b) U.S. Geological Survey (USGS) (or other Federal agency) reports.

(c) Local studies.

(d) Hydrologic engineering analyses from reconnaissance report.

(e) Initial Project Management Plan.

(f) Other.

(4) Obtain historic and design discharges, discharge-frequency relationships, high water marks, bridge designs, cross sections, and other data.

(a) Local agencies (city/county, highway departments, land use planning, etc.).

(b) State.

(c) Federal (USGS, Soil Conservation Service, U.S. Bureau of Reclamation, etc.).

(d) Railroads.

(e) Industries.

(f) Other.

(5) Scope major hydrologic engineering analysis activities.

(6) Prepare detailed Hydrologic Engineering Management Plan.

b. Obtain study area maps.

(1) County highway maps.

(2) USGS quadrangle maps.

(3) Aerial photographs.

(4) Others.

c. Estimate location of cross sections on maps (floodplain contractions, expansions, bridges, etc.). Determine mapping requirements (orthophoto) in conjunction with other disciplines.

d. Field reconnaissance.

(1) Interview local agencies and residents along the stream and review newspaper files, etc. for historic flood data (high water marks, frequency of road overtopping, direction of flow, land-use changes, stream changes, etc.). Document names, locations, and other data for future reference.

(2) Finalize cross-sectional locations/mapping requirements.

(3) Determine initial estimate of "n" values for later use in water surface profile computations.

(4) Take photographs or slides of bridges, construction, hydraulic structures, and floodplain channels and overbank areas at cross-sectional locations. Consider

dictating notes to a hand-held tape recorder to get a complete and detailed record.

e. Write survey request for mapping requirements and/or cross sections and high water marks.

B-3. Development of Basin Model

This phase of the analysis involves the selection of historic events to be evaluated, the development of runoff parameters from gauged data (and/or regional data from previous studies) to ungauged basins, and the calibration of the basin model to historic flood events. This step assumes at least some recording stream gauge data is in or near the study watershed.

a. Calibration of runoff parameters.

(1) Select historic events to be evaluated based on available streamflow records, rainfall records, highwater marks, etc.).

(2) From USGS rating curves and time versus stage relationships for each event, develop discharge hydrographs at each continuously recording stream gauge. Estimate peak discharge from floodcrest gauges.

(3) Develop physical basin characteristics (drainage areas, slope, length, etc.) for basin above each stream gauge.

(4) Select computation time interval (Δt) for this and subsequent analyses. The computation interval must:

(a) Adequately define the peak discharge of hydrographs at gauges.

(b) Consider type of routing and reach travel times.

(c) Have three to four points on the rising limb of the smallest subarea unit hydrographs of interest.

(d) Consider types of alternatives and future assessments.

(5) Using all appropriate rain gauges (continuous and daily), develop historic storm patterns that correspond to the selected recorded runoff events for the basins above the stream gauges.

(a) Average subarea totals--isoheytal maps.

(b) Temporal distribution--from weightings of nearby recording rain gauges.

(6) Determine best estimates of unit hydrograph and loss rate parameters for each event at each stream gauge.

(7) Make adjustments for better and more consistent results between events at each stream gauge. Adjustments are made to:

(a) Starting values of parameters.

(b) Rainfall totals and patterns (different weightings of recording rain gauges).

(8) Fix most stable parameters and rerun.

(9) Adopt final unit hydrograph and base-flow parameters for each gauged basin.

(10) Resimulate with adopted parameters held constant to estimate loss rates.

(11) Use adopted parameters of unit hydrographs, loss rates and base flow to reconstitute other recorded events not used in the above calibration to test the correctness of the adopted parameters and to "verify" the calibration results.

b. Delineation of subareas. Subareas are delineated at locations where hydrologic data are required and where physical characteristics change significantly.

(1) Index locations where economic damage computations are to be performed.

(2) Stream gauge locations.

(3) General topology of stream system.

(a) Major tributaries.

(b) Significant changes in land use.

(c) Significant changes in soil type.

(d) Other.

(4) Routing reaches.

(5) Location of existing physical works (reservoirs, diversions, etc.) and potential location of alternate flood reduction measures to be studied.

c. Subarea rainfall-runoff analysis of historic events.

(1) Subarea rainfall.

(a) Average subarea rainfall--from isohyetal maps.

(b) Temporal distribution--weighting in accordance with information from nearby recording raingages.

(2) Average subarea loss rates.

(a) From adopted values of optimization analyses.

(b) From previous studies of similar basins in the region.

(c) Others.

(3) Unit Hydrograph Parameters.

(a) From relationships based on calibration results at stream gauges and physical basin characteristics.

(b) From previous regional study relationships of unit hydrograph parameters and physical basin characteristics.

(c) From similar gauged or known basins.

(d) From judgment, if no data is available.

d. Channel routing characteristics.

(1) Modified puls from water surface profile computations (HEC-2).

(2) Optimized from stream gauge data (HEC-1).

(3) Adopted parameters from previous studies, experience, etc.

e. Reservoir routing (if reservoirs are present). This type of routing must be performed where storage has a significant effect on reach outflow values, with reservoirs being the most notable example. However, one must also apply these techniques where physical features warrant; such as, roads crossing a floodplain on a high fill, especially where culverts are used to pass the flow downstream.

(1) Develop area-capacity data (elevation area-storage relationships).

(2) Develop storage-outflow functions based on outlet works characteristics.

f. Generate hydrographs. Including the routing information of paragraph B-4, generate historic runoff hydrographs at locations of interest by combining and routing through the system for each flood.

B-4. Hydraulic Studies

These studies are used to determine water surface profiles, economic damage reaches, and modified puls channel routing criteria.

a. Prepare water surface profile data.

(1) Prepare cross sections (tabulate data from each section).

(a) Make cross sections perpendicular to flow.

(b) Ensure sections are typical of reaches upstream and downstream of cross section.

(c) Develop effective flow areas. If modified puls routing criteria is to be determined from water surface profile analyses, the entire section must be used (for storage) with high "n" values in the noneffective flow areas.

(2) Refine "n" values from field reconnaissance and from analytical calculation and/or comparison with "n" values determined analytically from other similar streams.

(3) Bridge computations--estimate where floods evaluated will reach on each bridge and select either:

(a) Normal bridge routine.

(b) Special bridge routine.

(4) Develop cross sections above and below bridges to model effective bridge flow (use artificial levees or ineffective flow area options, as appropriate).

b. Proportion discharges. Proportion discharges based on hydrologic analyses of historic storms and plot peak discharge versus river mile. Compute a series of water surface profiles for a range of discharges. Analysis should start below study area so that profiles will

converge to proper elevations at study limits. May want to try several starting elevations for the series of initial discharges.

c. Check elevations. Manually check all differences in water surface elevations across the bridge that are greater than 3 ft.

d. Obtain rating curves. The results are a series of rating curves at desired locations (and profiles) that may be used in subsequent analyses. Additional results are a set of storage versus outflow data by reach which, along with an estimate of hydrograph travel time, allow the development of modified puls data for the hydrologic model.

B-5. Calibration of Models to Historic Events

This study step concentrates on “debugging” the hydrologic and hydraulic models by recreating actual historic events, thereby gaining confidence that the models are reproducing the observed hydrologic responses.

a. Check hydrologic model.

(1) Check historic hydrographs against recorded data, make adjustments to model parameters, and rerun the model.

(2) If no stream gauges exist, check discharges at rating curves developed from water surface profiles at high water marks. Consider accuracy of gauged discharge measurements, + or - 5 percent or worse.

b. Adjust models to correlate with high water marks by ± 1 ft (rule of thumb--may not be applicable for all situations).

c. Adopt hydrologic and hydraulic model parameters for hypothetical frequency analysis.

B-6. Frequency Analysis for Existing Land-Use Conditions

The next phase of the analysis addresses how often specific flood levels might occur at all required points in the study watershed. This operation is usually done through use of actual gauge data (when available) to perform statistical frequency analyses and through hypothetical storm data to develop the stage-frequency relationships at all required points.

a. Determine and plot analytical and graphical frequency curves at each stream gauge. Adopt stage/discharge frequency relations at each gauge. Limit frequency estimate to no more than twice the data length (i.e., 10 years of data should be used to estimate flood frequencies no rarer than a 20-year recurrence interval event).

b. Determine hypothetical storms.

(1) Obtain hypothetical frequency storm data from NOAA HYDRO 35, NWS TP40 and 49, or from appropriate other source. Where appropriate, develop the standard project and/or the probable maximum storm.

(2) Develop rainfall pattern for each storm, allowing for changing drainage area within the watershed model.

c. Develop corresponding frequency hydrograph throughout the basin using the calibrated hydrologic model.

d. Calibrate model of each frequency event to known frequency curves. Adjust loss rates, base flow, etc. The frequency flows at ungauged areas are assumed to correlate to calibrated frequency flows at gauged locations.

e. If no streamflow records or insufficient records exist to develop analytical frequency curves, use the following procedure:

(1) Obtain frequency curves from similar nearby gauged basins.

(2) Develop frequency curves at locations of interest from previous regional studies (USGS, Corps of Engineers, state, etc.).

(3) Determine frequency hydrographs for each event from hydrologic model and develop a corresponding frequency curve at the locations of interest throughout the basin.

(4) Plot all the frequency curves (including other methods if available) and based on engineering judgement adopt a frequency curve. This curve may actually be none of these but simply the best estimate based on the available data.

(5) Calibrate the hydrologic model of each frequency event to the adopted frequency curve. The frequency

curve at other locations may be determined from the calibrated model results, assuming consistent peak flow frequencies.

f. Determine corresponding frequency water surface elevations and profiles from the rating curves developed by the water surface profile evaluations.

B-7. Future Without-Project Analysis

Where hydrologic and/or hydraulic conditions are expected to significantly change over the project life, these changes must be incorporated into the H&H analysis. Urbanization effects on watershed runoff are the usual future conditions analyzed.

a. From future land use planning information obtained during the preliminary investigation phase, identify areas of future urbanization or intensification of existing urbanization.

(1) Types of land use (residential, commercial, industrial, etc.).

(2) Storm drainage requirements of the community (storm sewer design frequency, on site detention, etc.).

(3) Other considerations and information.

b. Select future years in which to determine project hydrology.

(1) At start of project operation (existing conditions may be appropriate).

(2) At some year during the project life (often the same year as whatever land-use planning information is available).

c. Adjust model hydrology parameters for all sub-areas affected by future land-use changes.

(1) Unit hydrograph coefficients reflecting decreased time-to-peak and decreased storage.

(2) Loss-rate coefficients reflecting increased imperviousness and soil characteristics changes.

(3) Routing coefficients reflecting decreased travel times through the watersheds hydraulic system.

d. Operate the hydrology model and determine revised discharge-frequency relationships throughout the watershed for future without project conditions.

B-8. Alternative Evaluations

For the alternatives jointly developed with the members of the interdisciplinary planning team, modify the hydrologic and/or hydraulic models to develop the effects of each alternative (individually and in combination) on flood levels. Alternatives can include both structural (reservoirs, levees, channelization, diversions, pumping, etc.) or nonstructural (flood forecasting and warning, structure raising or relocation, flood proofing, etc.). Considerably less hydrologic engineering effort is necessary for modeling non-structural alternatives compared to structural.

a. Consider duplicating existing and future without-project hydrologic engineering models for individual analysis of each alternative or component.

b. Model components. Most structural components are usually modeled by modifying storage outflow relationships at the component location and/or modifying hydraulic geometry through the reach under consideration. The charts given in Chapter 3 of EM 1110-2-1416 contain more information on the analysis steps for each of the following alternatives:

(1) Reservoirs--adjust storage-outflow relationships based on spillway geometry and height of dam.

(2) Levees--adjust cross-sectional geometry based on proposed levee height(s). Evaluate effect of storage loss behind levee on storage-outflow relationships and determine revised discharge-frequency relationships down stream and upstream, if considered significant.

(3) Channels--adjust cross-sectional geometry based on proposed channel dimensions. Evaluate effect of channel cross section and length of channelization on flood plain storage, modify storage-outflow in reach, and determine revised downstream discharge-frequency relationships, if considered significant.

(4) Diversions--adjust hydrology model for reduction of flow downstream of the diversion and to identify where diverted flow rejoins the stream (if it does).

(5) Pumping--adjust hydrology model for various pumping capacities to be analyzed.

c. Evaluate the effects of potential components on sediment regime.

(1) Qualitatively--for initial screening.

(2) Quantitatively--for final selection.

d. Consider nonstructural components.

(1) Floodproofing/structure raises--elevations of design events primarily.

(2) Flood forecasting--development of real-time hydrology model, determination of warning times, etc.

e. Perform alternate evaluation and selection. Alternative evaluation and selection is an iterative process, requiring continuous exchange of information between a variety of disciplines. An exact work flow or schematic is not possible for most projects, thus paragraph B-8 could be relatively straightforward for one or two components or quite complex, requiring numerous reiterations as more cost and design information is known as project refinements are made. Paragraph B-8 is usually the area of the HEMP requiring the most time and cost contingencies.

B-9. Hydraulic Design

This paragraph and paragraph B-8 are partly intertwined, as hydraulic design must be included with the sizing of the various components, both to operate hydrologic engineering models and to provide sufficient information for design and costing purposes. Perform hydraulic design

studies commensurate with the level of detail of the reporting process.

a. Reservoirs--dam height, spillway geometry, spillway cross section, outlet works (floor elevation, length, appurtenances, etc.), scour protection, pool guide taking line, etc.

b. Levees--levee design profile, freeboard requirements, interior drainage requirements, etc.

c. Channels--channel geometry, bridge modifications, scour protection, channel cleanout requirements, channel and bridge transition design, etc.

d. Diversions--similar to channel design, also diversion control (weir, gates, etc.)

e. Pumping--capacities, start-stop pump elevations, sump design, outlet design, scour protection, etc.

f. Nonstructural--floodproofing or structure raise elevations, flood forecasting models, evacuation plan, etc.

B-9. Prepare H&H Report in Appropriate Level of Detail

The last step will be to thoroughly document the results of the technical analyses in report form. Hydrologic and hydraulic information presented will range from extensive for feasibility reports to very little for most FDM's.

a. Text.

b. Tables.

c. Figures.